

Estimado cliente:

He aquí el nuevo catalogo de productos 2010. Encontrara en él una amplia gama de artículos a su disposición.

Es nuestra intención proveerle una herramienta de trabajo que le permita encontrar el producto adecuado a su necesidad.

Le hacemos algunas sugerencias para facilitar su uso:

Los productos están ordenados por familia, excepto algunos que, dada su adaptabilidad a distintos usos, no encuadran en un solo rubro determinado, por lo cual sugerimos utilizar siempre para la búsqueda el índice alfabético.

Utilice los códigos al momento de hacer una consulta o pedido, eso facilitará la comprensión de su necesidad y evitará errores en los envíos de mercadería. Tenga en cuenta al pedir la cantidad del producto que debe estar referida a la unidad de medida en que se vende. Por ej. si ud.. quiere 100 uds de un producto cuya unidad de medida es "cien", debe pedir "uno".

Los datos y medidas consignados en el catalogo son provistos por el fabricante y pueden sufrir cambios. Tenga a bien consultar si su trabajo depende de una medida o peso indicada en el listado.

Esperamos que sea de su utilidad, y como siempre, ante cualquier duda estamos a su disposición.



RUBROS DEL CATALOGO

MANIJAS

Pág. 1 a 32

- Manijas para Obra
- Pomos
- Bocallaves y accesorios
- Cubetas
- Manijas para muebles

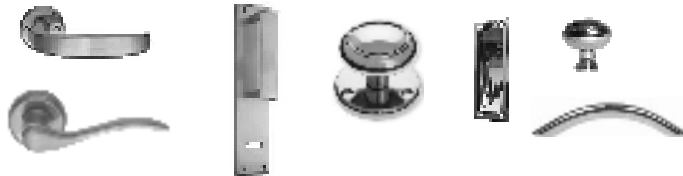

BISAGRAS

Pág. 33 a 52

- Bisagras para Obra
- Bisagras para Muebles
- Accesorios para Bisagras



CERRADURAS

Pág. 53 a 82

- Cerraduras para obra
- Cerraduras para muebles
- Candados
- Llaves y Afines

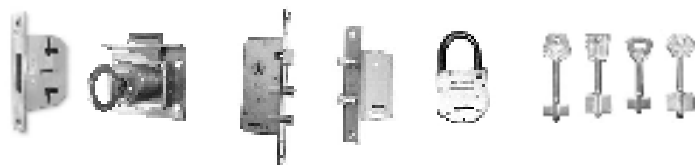

PASADORES TRABAS Y CIERRES

Pág. 83 a 106

- Aldabas, cierres, trabas
- Pasadores
- Fallebas
- Cierres , retenes, topes

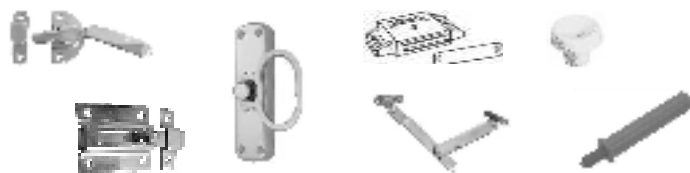

EQUIPAMIENTO PARA MUEBLES

Pág. 107 a 146

- Accesorios para cocinas
- Interiores de placards
- Escritorios – TV
- Correderas para cajón
- Puertas – Perfiles
- Patas y ruedas para muebles
- Ensambladores-Angulos
- Cubretornillos-Arandelas-Tuercas ciegas



HERRAJES DE MOVIMIENTO Y CORREDIZOS

Pág. 147 a 174

- Herrajes para portones
- Carros y rieles
- Ruedas para ventanas y placards
- Herrajes para aberturas
- Cortineria
- Cierrapuertas

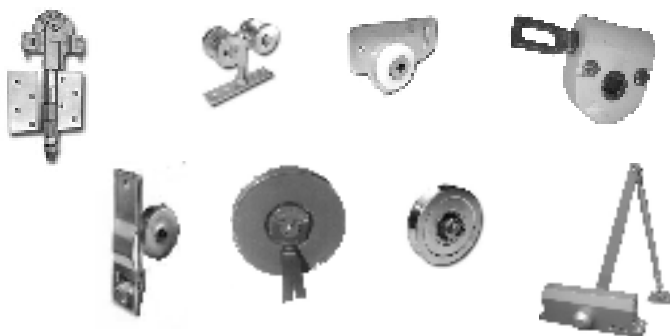

EQUIPAMIENTO PARA OBRA

Pág. 175 a 194

- Accesorios para cortinas
- Accesorios para rejas
- Buzones – tapas
- Cajas fuertes - Tesoros
- Carteles-Accesorios para puertas
- Colgadores-Perchas-Tenders



SOPORTES

Pág. 195 a 206

- Soportes para estantes
- Soportes para espejos y vidrios
- Soportes para repisas-cuadros
- Soportes para pasamanos-barrales
- Soportes para tirantería



ELEMENTOS DE FIJACIÓN

Pág. 207 a 224

- Tornillos
- Tarugos
- Pitones-Ganchos
- Clavos

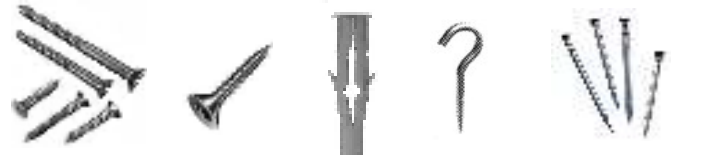

ADHESIVOS Y LACAS

Pág. 225 a 230

- Adhesivos
- Lacas para Madera-Tintas
- Lacas para metal



ABRASIVOS-HERRAMIENTAS

Pág. 231 a 234

- Lijas
- Discos de corte



HERRAMIENTAS-ACCESORIOS

Pág. 235 a 239

- Mechas
- Metros de madera
- Lápiz carpintero
- Sierra cinta para madera
- Fresas para tupi
- Formones
- Prensas para carpintería
- Destornilladores

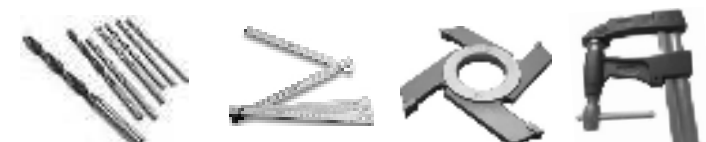

INDICE ALFABETICO

A	
ACCESORIOS P/ FALLEBAS	99
ACCESORIOS P/COCINAS	113
ADAPTADOR P/ MIRADOR	189
AIREDORES	163
ALAMBRES PARA CORTINA	169
ALDABAS	83
ANGULOS PLANOS	140
APARATO BANDEROLA	163
APARATO GUILLOTINA	165
APARATO MARAVILLA	168
APARATO MOLINILLO	164
APARATO SIMPLON	163
APARATO SUAVELEV	169
APLIQUES PARA REJAS	183
ARANDELAS CUNA	146
ARANDELAS P/ BISAGRAS	51
ARGOLLAS PARA LLAVES	81
ARGOLLAS P/ POSTIGON	17
AUTOMAT. DE PORTONES	153
AMORTIGUADORES P/MUE	104
B	
BANDEJAS GIRAT. P/T.V.	122
BANDEJAS PARA DINERO	187
BARNICES PARA MADERA	227
BARRAL EXTRAIBLE	118
BARRAL DE MADERA Y ACC	177
BARRALES PARA BAÑO	116
BASES PARA RUEDAS	136
BISAGRA BAIBEN 2000	40
BISAGRA O.H.	43
BISAGRA T	41
BISAGRA 1842	41
BISAGRA A RESORTE	48
BISAGRA ARTICULADA	48
BISAGRA CARROCERA	41
BISAGRA DE 90 Y 180 GR.	48
BISAGRA ESCALERA	41
BISAGRA EXTRA REFORZ.	42
BISAGRA FICHA MUEBLE	46
BISAGRA FICHA OBRA	37
BISAGRA FICHA HERRERO	38
BISAGRA FORJADA	39
BISAGRA INVISIBLE	46
BISAGRA LIBRO	44
BISAGRA MACIZA BB	46
BISAGRA MUNICION	33
BISAGRA P/ BANDEROLA	163
BISAGRA P/CORT.BARRIO	169
BISAGRA P/ESTUCHE	44
BISAGRA P/MESA LIBRO	46
BISAGRA P/MESA TRAMPA	46
BISAGRA P/ MOSQUITERO	41
BISAGRA P/PERFIL ALUM.	37
BISAGRA P/MBLE COCINA	49
BISAGRA P/PORTON ROMA	149
BISAGRA P/VIDRIO	48
BISAGRA PESTAÑA	46
BISAGRA PIANO	44
BISAGRA PIVOT DE PISO	39
BISAGRA PIVOT P/MUEBLE	47

BISAGRA PIVOT P/VIDRIO	47
BISAGRA POMELA	35
BISAGRA TORNEADA	38
BISAG.VAIVEN (DOB.Y S/A)	39
BIS Y ROTULA P/PORTON	149
BLOQUEO TRABEX	85
BOCALLAVE P/BAÑO	17
BOCALLAVE P/MUEBLE	29
BOCALLAVE P/OBRA	17
BOTINEROS	117
BRIDA PARA CORTINA	105
BRAZO DE EMPUJE	87
BROCHES P/CAJAS	105
BROCHES P/VALIJAS	105
BROCAS METALICAS	214
BULONES PARA CAMA	139
BUZONES	185
C	
CABEZAS PARA LLAVE	29
CADENA DE SEGURIDAD	85
CADENA ESCALERA	163
CADENA NUDO	163
CAJA PARA ENROLLADOR	168
CAJA PORTACERRADURA	183
CAJA PORTALLAVEROS	187
CAJAS DE SEGURIDAD	188
CAJAS PORTAVALORES	187
CAJONES PARA DINERO	121
CANASTOS CROMADOS	107
CANASTOS BAJO ALACENA	107
CANASTOS BAJOMESADA	107
CANDADOS	75
CAÑOS PLACARD	119
CAÑOS EXTENS.P/BAÑO	178
CAÑO CROMO P/COCINA	111
CAPUCHON PARA BIS.	51
CARROS CAMA	120
CERRADURAS P/MUEBLES	67
CARROS P/PUERTAS CORR.	155
CARROS P/PERFIL ALUM.	160
CARROS P/PORTONES	149
CARROS P/VITRINAS	160
CARTELES P/BAÑOS	191
CATALIZADOR P/RESINA	225
CEMENTO DE CONTACTO	225
CERRADURAS ACYTRA	53
CERRADURAS AN DIF	54
CERRAD.ANTIPANICO	56
CERRADURAS ANUAC	54
CERRADURAS ATRACTIC	68
CERRADURAS CANDEX	54
CERRADURAS ELEFANTE	56
CERRADURAS EYRO	55
CERRADURAS EVERGOOD	73
CERRADURAS GIACO	56
CERRADURAS JAQUE	56
CERRADURAS KALLAY	57
CERRAD. CANOA (MUEBLE)	67
CERRAD. CERRATEX(MBLE)	68
CERRADURAS EVERGOOD	73
CERRADURAS MERLE	69

CERRADURAS MERONI	53
CERRADURAS 8 BLOQ	63
CERRADURAS ELECTRICAS	55
CERRADURAS MAC	58
CERRADURAS P/CORRED.	63
CERRADURAS P/PLEGAD.	63
CERRADURAS POLI	55
CERRADURAS PRIVE	59
CERRADURAS ROA	60
CERRADURAS SEB	60
CERRADURAS STAR	61
CERRADURAS TRABEX	62
CERRADURAS YANK	53
CERRADURAS YALTRES	62
CHASIS PORTACARPETAS	121
CHASIS PORTATECLADOS	121
CIERRAPUER. HIDRAULICO	171
CIERRAPUER. MOSQUIT.	172
CIERRE A CREMALLERA	85
CIERRE P/PUERTA DE GAS	85
CIERRE VIGILANTE	85
CIERRE A CADENA	85
CIERRE P/VENT.CORRED.	83
CIERRE P/VENT.GUILLOT.	85
CIERRES VARIOS	86
CINTA DE ENMASCARAR	238
CINTA P/CORTINA	167
CLAVIJA P/MANIJA	17
CLAVOS BRONCEADOS	222
CLAVOS DE ACERO	222
CLAVOS DE HIERRO	221
CLAVOS ESCUADRA	221
COLA FRIA /CALIENTE	225
COLA SINTETICA	225
CONECTORES P/MUEBLE	139
CORAZA LIBRE OCUPADO	191
CORAZON PLAST.COR.BAR.	169
CORBATEROS EXTRAIBLE	118
CORREDERAS P/CAJON	125
CRICQUET LONERO	157
CUBETAS	19
CUBIERTEROS	114
CUERDAS P/CIERRAPUERT.	172
CUÑA PLACARD	139
D	
DESTORNILLADORES	238
DILUYENTE P/CEMENTO	225
DILUYENTE P/POLIURET.	228
DISCOS DE CORTE	233
DISTANCIADOR P/VIDRIO	138
E	
EJE OCTOGONAL	167
ELEVADOR DE ROPA	118
ENROLLADORES P/CORT.	168
ENSAMBLADORES P/MBLE	139
EQUIPOS AUTOM.P/PORT.	153
ESCUADRAS ANGULO	141
ESCUADRAS P/ALACENA	199
ESCUADRAS PLANAS	140
ESCUADRAS P/TABIQUES	116

ESCURREPLATOS	111
ESQUINEROS P/VIDRIO	201
ESTABILIZADOR P/VENTAN	160
EXTENSIBLES P/BAÑO	178
F	
FALLEBAS ARRIMAR 12 MM	95
FALLEBAS ARRIMAR 18 MM	96
FALLEBAS CAJA OVALADA	97
FALLEBAS CELOSIA	97
FALLEBAS DE EMBUTIR	95
FALLEBAS DE EMBUTIR 18	97
FALLEBAS FORJADAS	99
FALLEBAS GOLIAT	98
FELPITAS PARA SILLAS	138
FIELTRO PARA LIJADORA	232
FLEJE P/CORTINA BARRIO	169
FLEJE PARA ALFOMBRA	192
FORMONES	237
FRESAS PARA MADERA	237
G	
GANCHOS C/VIENTO BRCE.	88
GANCHOS C/VIENTO HIER.	218
GANCHOS P/CAMA	139
GANCHOS P/HAMACA	219
GRAMPAS P/AMUR.MARCO	192
GRAMPAS U COBREADAS	223
GRAMPAS P/CORTINA	167
GRAMPAS P/RUEDA PORT.	153
GRAPODINAS P/BISAGRA	51
GUARNICIONES FALLEBA	99
GUIAS DE PISO P/CORRED.	156
GUIAS "U" P/PORTONES	148
H	
HERRAJE LEVADIZO	150
HERRAJE CORREDIZO	147
HERRAJE P/BAÑO	18
HERRAJES P/TABIGUES	116
HERRAJE P/CORT.BARRIO	169
HERRAJE P/PLEGADIZA	17
HERRAJE P/POSTIGON	165
HIERROS P/FALLEBA	98
HERRAJE PUERTA OCULTA	126
HERRAJES P/CAMIONES	157
I	
IMANES PARA MUEBLES	101
INTERMEDIOS P/REJAS	180
L	
LACAS PARA MADERA	227
LACAS PARA METALES	229
LAPIZ CARPINTERO	236
LAPIZ PARA CERAMICA	235
LETRAS DE BRONCE	190
LIBERA PEST.ELECTRICO	55
LIJAS	231
LLAVEROS IDENTIFICAT.	81
LLAVES CRUZ	82
LLAVES DOBLE PALETA	79
LLAVES DE AUTOSY MOTO	81
LLAVES YALE	81
LLAVIN PARA BAÑO	18

M	
MANIJAS DE MADERA	21
MANIJAS PARA BAUL	31
MANIJAS PARA CAJAS	31
MANIJAS PORTAETIQUETA	31
MANIJAS PARA MOLINILLO	164
MANIJAS PARA MUEBLES	21
MANIJAS PARA OBRA	1
MANIJAS PARA OBRA FINAS	4
MANIJAS FORJADAS	10
MANIJAS PARA PLEGADIZA	17
MANIJAS PARA VIDRIO	48
MANIJONES	2
MASILLA PARA MADERA	228
MECHA RADIAL	235
MECHAS PARA BARRENO	236
MECHAS DE WIDIA	235
MENSULAS PARA RIELES	196
MENSULAS REBATIBLES	197
METROS	236
MIRADOR OPTICO	189
MIRADOR PUERTA CALLE	189
MIRILLA ASCENSOR	189
MOLINILLOS PARTOLDOS	164
MOVIMIENTOS P/POSTIGON	165
N	
NUECES PACERRADURAS	80
NUMEROS	190
P	
PANTALONEROS	118
PASACABLES	121
PASACINTAS CORTNA	168
PASADORES A PALANCA	92
PASADORES A UÑA	89
PASADORES FORJADOS	92
PASADORES P/BANDEROLA	94
PASADORES PARA MUEBLE	89
PASADORES PARA OBRA	90
PASADORES "VERSALLES"	99
PASADORES HERRERO	94
PASADOR "CHINGOLO"	94
PASADOR BEMA	94
PATAS PARA ESCRITORIOS	122
PATAS PARA MESAS	137
PATAS PARA MUEBLES	136
PATIN GIRATORIO T.V.	122
PATINES METALICOS	137
PERCHAS	193
PERCHERO EXTRAIBLE	118
PERSIGUR (TRABA CORT.)	86
PERFILES PARA PUERTAS	129
PERFILES PARA PLACARDS	130
PERFILES PARA VITRINAS	131
PERFILES MANIJA P/MEBLE	129
PERSIANAS PARA MUEBLE	130
PESTILLOS P/CERRADURA	80
PISOS DE ALUMINIO	115
PITONES BRONCEADOS	217
PITONES CON TUERCA	217
PITONES PARA MADERA	215
PITONES PARA TARUGO	218

PÍVOT PARA MUEBLE	47
PIVOT PARA PISO	39
PIVOT PARA VIDRIO	47
PLANCHUELAS CINCADAS	141
PLANCH.PORTACANDADO	105
PLANTILLA PARA OH	238
POLEAS DE CHAPA	167
POLEAS DE REDUCCION	167
POMELAS	35
POMOS PARA BAÑO	18
POMOS PARA PUERTAS	13
PORTACARTPETAS	121
PORTACOPAS	115
PORTACOMPACTS	122
PORTAETIQUETAS	31
PORTAROLLO DE COCINA	111
PORTARESIDUOS	108
PORTATECLADOS	121
PORTA CPU	121
PROTECCION DE MUROS	182
PUNTAS DE EJE P/CORTINA	167
PUNTAS P/IATORNILLADOR	238
PUNTAS PARA REJAS	179
PUÑO GOLIAT	98
R	
REDUCTORTES P/CORTINA	167
REJILLA PORTA COMPACT	122
REJILLAS DE VENTILACION	189
RESINA UREICA	225
RESORTES P/BIS.VAIVEN	51
RESORTES P/CIERRAPUER.	172
RESORTES P/MOSQUITERO	51
RESPIRADEROS P/PLACAR	189
RETTENES A IMAN	101
RETTENES A PRESION	101
RETTENES A RODILLO	101
RETTENES PARA MUEBLES	101
RETTENES PARA POSTIGON	87
RETTENES PARA PUERTAS	86
RIELES PARA CORTINA	177
RIELES PARA MENSULAS	196
RIELES P/CORRED.(OBRA)	156
RIELES PARA VITRINA	162
RIELES P/CORRED.MBLE	160
RODILLO DE EMP. BARRIO	169
RODILLO GUIA CORR.RECT.	153
ROLDANAS P/SOGA	194
ROLLETES P/CORRED.	156
ROLLETES P/PORTON	149
ROSETAS PARA MANIJAS	17
ROLDANA P/LEVADIZO	150
RUEDA CAMERA	134
RUEDAS CON GOMA	134
RUEDAS PARA CARROS	134
RUEDAS PARA MUEBLES	133
RUEDA DE APLICAR PLAST.	133
RUEDAS PARA PORTON	152
RUEDAS PARA CORREDIZ.	159
RULEMANES P/PORTONES	150
RULEMANES ROMA	160
RULEMANES P/CORTINA	167

S	
SELLADOR P/MADERAS	227
SELLADOR DE SILICONAS	226
SILUETA DAMA CABALLERO	191
SOPORTES MACIZO	119
SOPORTES P/CAÑO PLAC	119
SOPORTES P/CAÑO CORT	175
SOPORTES P/BARRALES	203
SOPORTES P/CAÑO COCIN	111
SOPORTES PARA CRISTAL	197
SOPORTES PARA CUADRO	199
SOPORTES PARA ESPEJO	201
SOPORTES PARA ESTANTE	195
SOPORTES PARA MESADA	195
SOPORTES P/MESA REBAT.	197
SOPORTES PARA MONITOR	122
SOPORTES PARA LCD'S	199
SOPORTES PARA A.A.	199
SOPORTES P/PASAMANOS	203
SOPORTES P/RIELES ROMA	156
SOPORTES P/VISILLO	177
SOPORTES PARA TIRANTE	205
SOPORTES PLASTICOS	120
T	
TACO OCTOGONAL	167
TAPACANTOS DE ALUM	129
TAPACANTOS MELAMINIC	131
TAPACANTOS PVC	131
TAPAS P/CIERRAP.DE PISO	171
TAPAS P/BIS.A RESORTE	48
TAPAS PARA BUZON	185
TAPAS PARA CAÑOS	176
TAPAS PARA COLUMNAS	182
TAPAS PASACABLES	122
TAPAORIFICIOS	146
TAPATORNILLO ADHESIVA	145
TAPATORNILLO BRONCE	145
TAPATORNILLO PLASTICO	145
TAPATUERCAS	146
TARUGOS DE MADERA	142
TARUGOS DE NYLON	213
TEJIDO MOSQUITERO	192
TESOROS DISIMULADOS	187
TENDEDEROS	193
TENSORES	218
TENSORES P/CABLES/EST	198
TERMINALES PARA CAÑO	176
THINER	228
TIJERAS P/PUERTA CAMP.	102
TIJERAS P/PUERTA VOLC.	102
TINTAS PARA MADERA	228
TIRADORES DE MADERA	21
TIRADORES PARA MUEBLE	21
TIRADORES PLASTICOS	30
TIRAFONDOS	212
TOPE P/RIEL ROMA	156
TOPES DE GOMA P/MUEBLE	103
TOPES DE GOMA P/OBRA	191
TOPES DE CORTINA	167
TOPES PARA MANIJAS	192
TORNILLOS BRONCEADOS	208
TORNILLOS DE BRONCE	209
TORNILLOS DE HIERRO	207
TORNILLOS DRYWALL	212

TORNILLOS PARKER	211
TORNILLOS FIX	212
TORNILLOS PARA MANIJON	17
TORRECITAS DE MADERA	22
TORTUGAS DE FUNDICION	153
TRABA CENTRAL P/CORR.	84
TRABAS PARA CORTINAS	86
TRABAS P/PORTON CORR.	86
TRANSFORMADOR 16V	55
TUERCAS CIEGAS	146
TUERCAS ANTIGIRO	146
TORNILLOS P/CAMAS	139
U	
UNIONES PARA MODULOS	140
V	
VAIVENES A RODILLO	88
VARILLAS P/FALLEBAS	98
VARILLAS P/VISILLO	177
VARILLAS DE MADERA	143
VIGILANTE PARA PUERTA	85
VISOR PARA PUERTA	189
Z	
ZAPATAS PARA MUEBLES	137
ZOCALOS DE ALUMINIO	192

CUADROS Y TABLAS

CONTENIDO	
COMPARATIVO DE CERRADURAS	64
SELECCIÓN DE REDUCTOR DE CORTINA	170
SELECCIÓN DE CIERRAPUERTAS HIDRAUL.	173
SELECCIÓN DE HERRAJE DE PORTON	151
PESOS Y MEDIDAS DE CARROS Y RIELES ROMA	158

**INDICE DE CODIGOS
AL FINAL DEL
CATALOGO**

INDICE DE CODIGOS

CODIGO	Pag.	1020111	68	1040108	69	1040503	70	1041127	71	1041441	72
606421	232	1020112	68	1040109	69	1040504	70	1041133	71	1041445	72
1010101	67	1020113	68	1040110	69	1040511	70	1041135	71	1041446	72
1010102	67	1020114	68	1040111	69	1040601	70	1041141	71	1041447	72
1010103	67	1020115	68	1040112	69	1040602	70	1041143	71	1041450	72
1010104	67	1020117	68	1040113	69	1040603	70	1041149	71	1041451	72
1010105	67	1020119	68	1040114	69	1040604	70	1041151	71	1041455	72
1010106	67	1020120	68	1040115	69	1040605	70	1041157	71	1041456	72
1010107	67	1020121	68	1040201	69	1040606	70	1041159	71	1041457	72
1010108	67	1020122	68	1040202	69	1040607	70	1041165	71	1041460	72
1010109	67	1020123	68	1040203	69	1040608	70	1041167	71	1041461	72
1010110	67	1020124	68	1040204	69	1040609	70	1041201	71	1041462	72
1010111	67	1020125	68	1040205	69	1040611	70	1041202	71	1041465	72
1010112	67	1020126	68	1040206	69	1040612	70	1041204	71	1041466	72
1010116	67	1020127	68	1040207	69	1040613	70	1041207	71	1041467	72
1010117	67	1020128	68	1040208	69	1040614	70	1041210	71	1050101	53
1010124	67	1020135	68	1040209	69	1040615	70	1041211	71	1050102	53
1010125	67	1020201	68	1040210	69	1040616	70	1041212	71	1050103	53
1010126	67	1020202	68	1040211	69	1040617	70	1041213	71	1050104	53
1010128	67	1020203	68	1040212	69	1040618	70	1041214	71	1050105	53
1010129	67	1020204	68	1040213	69	1040619	70	1041215	71	1050106	53
1010130	67	1020205	68	1040214	69	1040621	70	1041301	72	1050107	53
1010131	67	1020301	194	1040215	69	1040622	70	1041302	72	1050108	53
1010132	67	1020302	194	1040216	69	1040623	70	1041303	72	1050113	53
1010201	67	1020303	194	1040217	69	1040624	70	1041304	72	1050114	53
1010202	67	1020310	194	1040218	69	1040625	70	1041305	72	1050115	53
1010203	67	1020311	194	1040219	69	1040626	70	1041306	72	1050120	53
1010206	67	1020312	194	1040220	69	1040627	70	1041308	72	1050201	53
1010207	67	1020313	194	1040221	69	1040801	70	1041309	72	1050202	53
1010208	67	1020710	102	1040222	69	1040802	70	1041310	72	1050203	53
1010215	67	1030101	77	1040223	69	1040803	70	1041401	72	1050204	53
1010216	67	1030102	77	1040224	69	1040804	70	1041402	72	1050209	53
1010301	67	1030103	77	1040225	69	1040805	71	1041404	72	1050210	53
1010302	67	1030104	77	1040226	69	1040806	71	1041405	72	1050215	53
1010303	67	1030105	77	1040227	69	1040807	71	1041406	72	1050301	53
1010304	67	1030106	77	1040228	69	1040811	71	1041410	72	1050302	53
1010305	67	1030107	77	1040229	69	1040812	71	1041411	72	1050303	53
1010306	67	1030201	77	1040230	69	1040813	71	1041412	72	1050304	53
1010308	67	1030202	77	1040231	69	1040814	71	1041413	72	1050306	53
1010310	67	1030301	77	1040232	69	1040815	71	1041420	72	1050307	53
1010311	67	1030302	77	1040233	69	1040816	71	1041422	72	1050308	53
1010312	67	1030303	77	1040301	70	1040817	71	1041423	72	1050309	53
1010313	67	1030401	77	1040302	70	1040902	71	1041424	72	1050401	75
1010323	67	1030402	77	1040303	70	1040903	71	1041425	72	1050402	75
1010324	67	1030403	77	1040304	70	1041001	71	1041426	72	1050403	75
1010325	68	1030501	77	1040402	70	1041002	71	1041430	72	1050405	75
1010326	68	1030502	77	1040404	70	1041007	71	1041431	72	1050406	75
1010327	68	1030601	77	1040406	70	1041008	71	1041432	72	1050407	75
1020101	68	1030602	77	1040412	70	1041009	71	1041433	72	1050409	75
1020103	68	1040101	69	1040414	70	1041101	71	1041434	72	1070100	54
1020105	68	1040102	69	1040416	70	1041103	71	1041435	72	1070119	54
1020106	68	1040103	69	1040422	70	1041109	71	1041436	72	1070121	54
1020107	68	1040104	69	1040424	70	1041111	71	1041437	72	1070123	54
1020108	68	1040105	69	1040426	70	1041117	71	1041438	72	1070124	54
1020109	68	1040106	69	1040501	70	1041119	71	1041439	72	1070125	54
1020110	68	1040107	69	1040502	70	1041125	71	1041440	72	1070126	54

INDICE DE CODIGOS

1070127	54	1090510	76	1101003	58	1120205	55	1174002	185	1190411	152
1070128	54	1090511	76	1101101	58	1120206	55	1174013	186	1190412	152
1070129	54	1090515	76	1101201	58	1120207	55	1174014	186	1190413	152
1070130	54	1090516	75	1101203	58	1120208	55	1174015	186	1190414	152
1070131	54	1090517	75	1101217	58	1120210	55	1174016	186	1190415	152
1070132	54	1090518	75	1101219	58	1120211	55	1174017	185	1190416	152
1070208	54	1100101	57	1101221	58	1120212	55	1174018	185	1190417	152
1070209	54	1100103	57	1101221	88	1120213	55	1174039	186	1190502	181
1090101	59	1100109	57	1101222	88	1120214	55	1174040	186	1190503	181
1090107	59	1100111	57	1101223	58	1120215	55	1174043	186	1190504	181
1090109	59	1100117	57	1101223	88	1120216	54	1174044	186	1190513	183
1090116	59	1100118	57	1101301	58	1120217	55	1174101	185	1190516	183
1090121	59	1100121	57	1101303	58	1120218	55	1174110	55	1190518	183
1090124	59	1100122	57	1101401	58	1120219	54	1190101	172	1190519	183
1090128	59	1100123	57	1101402	58	1140100	62	1190102	172	1190520	183
1090129	59	1100125	57	1101407	58	1140101	62	1190103	172	1190523	181
1090132	59	1100126	57	1101408	58	1140105	62	1190104	172	1190534	181
1090136	59	1100130	57	1110103	62	1140150	62	1190105	172	1190539	181
1090201	59	1100131	57	1110104	62	1140170	62	1190106	172	1190606	181
1090203	59	1100201	57	1110107	62	1140180	62	1190107	172	1190608	181
1090207	59	1100202	57	1110109	62	1140186	62	1190108	172	1190612	181
1090209	59	1100205	57	1110111	62	1140190	62	1190109	172	1190615	181
1090211	59	1100206	57	1110113	62	1140195	62	1190110	172	1190505	182
1090215	59	1100213	57	1110114	62	1140205	62	1190111	172	1190502	182
1090216	59	1100214	57	1110117	62	1140207	62	1190112	172	1190504	182
1090217	59	1100301	58	1110119	62	1140210	91	1190113	172	1190506	182
1090218	59	1100303	58	1110126	62	1140211	91	1190114	172	1200101	81
1090219	59	1100309	14	1110127	62	1140212	62	1190115	172	1200103	81
1090223	59	1100312	58	1110201	62	1140213	62	1190116	172	1200105	81
1090227	59	1100401	57	1110202	62	1140215	62	1190117	172	1200107	81
1090228	59	1100402	57	1110205	62	1140216	62	1190125	172	1200109	81
1090231	59	1100434	58	1110206	62	1140217	62	1190126	172	1200125	81
1090232	59	1100438	58	1110207	62	1140219	62	1190127	172	1230201	56
1090234	59	1100501	57	1110210	62	1140221	62	1190201	172	1230301	56
1090235	59	1100503	57	1110220	62	1140301	62	1190202	172	1230407	56
1090237	59	1100507	57	1110305	85	1140304	62	1190203	172	1230501	56
1090241	59	1100508	57	1110402	75	1150101	171	1190205	39	1230502	56
1090242	59	1100511	57	1110403	75	1150102	171	1190206	39	1230601	56
1090243	59	1100512	57	1110404	75	1150103	171	1190207	39	1230605	56
1090244	59	1100515	57	1110405	86	1150104	171	1190208	39	1240601	105
1090246	59	1100516	57	1110406	86	1150205	171	1190301	153	1240602	105
1090301	59	1100519	57	1110407	86	1150206	171	1190302	153	1240603	105
1090302	59	1100520	57	1120101	54	1150207	171	1190303	153	1240604	105
1090304	59	1100523	57	1120103	54	1150301	171	1190304	153	1240605	105
1090305	59	1100524	57	1120109	54	1150302	171	1190305	153	1240610	105
1090306	59	1100601	57	1120110	54	1150303	171	1190306	153	1240611	105
1090320	59	1100602	57	1120111	54	1150501	171	1190307	153	1240612	105
1090321	59	1100605	57	1120112	54	1150502	171	1190308	153	1240613	105
1090413	59	1100606	57	1120113	54	1150503	171	1190310	153	1240614	105
1090414	60	1100609	57	1120114	54	1150802	172	1190401	152	1240620	105
1090420	60	1100610	57	1120115	54	1150820	172	1190402	152	1240621	105
1090501	76	1100617	57	1120116	54	1150821	172	1190403	152	1240622	105
1090502	76	1100625	57	1120120	55	1150824	172	1190404	152	1240623	105
1090503	76	1100626	57	1120121	55	1150825	172	1190405	152	1240624	105
1090504	76	1100701	57	1120122	55	1151010	172	1190406	152	1240625	105
1090505	76	1101001	58	1120201	55	1174001	185	1190407	152	1241001	55

INDICE DE CODIGOS

1241002	55	1300109	63	1370603	81	1390402	187	1501004	79	1501852	79
1250101	75	1300201	63	1370604	81	1390403	187	1501005	79	1501901	79
1250102	75	1300305	63	1370701	81	1390501	92	1501006	79	1501902	79
1250201	60	1300401	63	1370702	81	1500101	79	1501007	79	1501903	79
1250202	60	1300501	63	1370703	81	1500102	79	1501008	79	1501904	79
1250204	60	1300505	63	1370704	82	1500103	79	1501009	79	1501905	79
1250206	60	1300601	63	1370705	82	1500104	79	1501101	79	1501906	79
1250207	60	1301001	58	1370706	82	1500105	79	1501102	79	1501907	79
1250310	60	1301003	58	1370801	82	1500106	79	1501103	79	1501908	79
1250311	60	1301010	58	1370802	82	1500107	79	1501104	79	1501909	79
1250312	60	1301020	58	1370803	82	1500108	79	1501201	79	1501910	79
1250501	60	1301101	58	1370804	82	1500201	79	1501202	79	1501911	79
1250502	60	1310102	55	1370805	82	1500202	79	1501203	79	1501912	79
1250503	60	1310103	55	1370806	82	1500203	79	1501204	79	1501913	79
1250506	60	1320101	56	1370807	82	1500204	79	1501205	79	1501914	79
1250507	60	1320102	56	1370808	82	1500205	79	1501206	79	1501915	79
1250510	60	1320105	56	1370809	82	1500206	79	1501207	79	1501916	79
1250512	60	1320106	56	1370810	82	1500207	79	1501208	79	1501917	79
1250520	60	1320201	56	1370811	82	1500208	79	1501301	79	1501918	79
1250521	60	1370401	81	1370812	82	1500209	79	1501302	79	1501919	79
1280101	60	1370402	81	1370813	82	1500301	79	1501303	79	1501920	79
1280102	60	1370403	81	1370901	82	1500302	79	1501304	79	1501921	80
1280103	60	1370404	81	1370902	82	1500303	79	1501305	79	1501922	80
1280201	60	1370405	81	1370903	82	1500305	79	1501401	79	1501923	80
1280202	60	1370406	81	1390101	187	1500401	79	1501402	79	1502001	80
1280203	60	1370407	81	1390102	187	1500402	79	1501801	79	1502002	80
1280301	60	1370408	81	1390103	187	1500403	79	1501803	79	1502003	80
1280302	60	1370409	81	1390105	187	1500404	79	1501805	79	1502004	80
1280303	60	1370501	81	1390106	187	1500405	79	1501807	79	1502005	80
1280306	60	1370502	81	1390120	188	1500406	79	1501809	79	1502006	80
1280312	60	1370503	81	1390121	188	1500407	79	1501810	79	1502007	80
1280313	60	1370504	81	1390122	188	1500408	79	1501811	79	1502010	80
1281001	153	1370505	81	1390123	188	1500501	79	1501813	79	1502101	80
1281002	153	1370506	81	1390124	188	1500502	79	1501815	79	1502102	80
1281003	153	1370507	81	1390125	188	1500503	79	1501817	79	1502103	80
1281004	153	1370508	81	1390150	188	1500504	79	1501819	79	1502104	80
1281301	88	1370509	81	1390151	188	1500505	79	1501821	79	1502105	80
1281302	88	1370510	81	1390152	188	1500506	79	1501823	79	1502301	80
1281303	88	1370511	81	1390153	188	1500601	79	1501825	79	1502302	80
1281304	88	1370512	81	1390154	188	1500701	79	1501827	79	1502305	80
1281305	88	1370513	81	1390155	188	1500702	79	1501829	79	1502306	80
1281306	88	1370514	81	1390170	188	1500801	79	1501831	79	1503001	80
1281402	86	1370515	81	1390171	188	1500802	79	1501833	79	1503003	80
1281403	86	1370516	81	1390172	188	1500803	79	1501835	79	1503005	80
1281501	139	1370517	81	1390173	188	1500804	79	1501836	79	1503006	80
1281502	139	1370518	81	1390180	188	1500805	79	1501837	79	1503009	80
1281503	139	1370519	81	1390181	188	1500806	79	1501838	79	1503010	80
1281520	171	1370520	81	1390182	188	1500901	79	1501839	79	1503013	80
1281521	171	1370521	81	1390183	188	1500902	79	1501840	79	1503015	80
1281701	191	1370522	81	1390190	188	1500903	79	1501842	79	1503016	80
1281702	191	1370523	81	1390191	188	1500904	79	1501843	79	1503017	80
1281703	191	1370524	81	1390201	188	1500905	79	1501845	79	1503018	80
1290101	54	1370525	81	1390202	188	1500906	79	1501846	79	1503019	80
1290102	54	1370526	81	1390203	188	1501001	79	1501847	79	1503020	80
1300101	63	1370601	81	1390204	188	1501002	79	1501849	79	1503022	80
1300105	63	1370602	81	1390401	187	1501003	79	1501850	79	1503024	80

INDICE DE CODIGOS

1503101	80	2000133	98	2020503	94	2021102	160	2070126	91	2090103	93
1503102	80	2000134	98	2020504	94	2021104	160	2070127	91	2090104	93
1503103	80	2000140	98	2020505	94	2021105	160	2070128	91	2090105	93
1503105	80	2000142	98	2020506	94	2021106	160	2070200	90	2090106	93
1503106	80	2000143	98	2020507	94	2021108	160	2070201	90	2090107	93
1503107	80	2000144	98	2020508	94	2021109	160	2070202	90	2090108	93
1503108	80	2000160	98	2020509	94	2021110	160	2070203	90	2090503	95
1503109	80	2000161	98	2020520	94	2021112	160	2070204	90	2090504	95
1503111	80	2000170	98	2020601	93	2021501	87	2070209	90	2090505	95
1503112	80	2000171	98	2020602	93	2021502	87	2070210	90	2090506	95
1503114	80	2000180	98	2020603	93	2021503	87	2070211	90	2090507	95
1503115	80	2000501	95	2020604	93	2021504	87	2070212	90	2090508	95
1503118	80	2000502	95	2020608	93	2021505	87	2070213	90	2090523	95
1503119	80	2000503	95	2020609	93	2021506	87	2070220	90	2090601	95
1503121	80	2000510	95	2020610	93	2021507	87	2070221	90	2090602	95
1503122	80	2000511	95	2020611	93	2021510	87	2070222	90	2090603	95
1503124	80	2000512	95	2020615	93	2021511	87	2070302	105	2090604	95
1503125	80	2000520	97	2020616	93	2021512	87	2070304	105	2090605	95
1503126	80	2000530	95	2020617	93	2021513	87	2070306	105	2090606	95
1503127	80	2000531	96	2020618	93	2021514	87	2070308	105	2090702	95
1503128	80	2009996	192	2020701	93	2021515	87	2070310	105	2090703	95
1503130	80	2010001	83	2020702	93	2021517	87	2070312	105	2090704	95
1503149	80	2010002	83	2020703	93	2021550	10	2070314	105	2090705	95
1503201	80	2010003	83	2020704	93	2021551	10	2070316	105	2090706	95
1503202	80	2010004	83	2020705	93	2021552	10	2070318	105	2090707	95
1504001	80	2010101	83	2020706	93	2021553	10	2080101	94	2090708	95
1505001	80	2010102	83	2020707	93	2021554	10	2080102	94	2090709	95
1530101	56	2010219	84	2020708	93	2021555	10	2080103	94	2090710	95
1530102	56	2010220	84	2020709	93	2021556	10	2080104	94	2090711	95
1530160	56	2020102	89	2020710	93	2021557	10	2080105	94	2090712	95
1530161	56	2020103	89	2020711	93	2021558	10	2080106	94	2090713	95
1530162	56	2020104	89	2020712	93	2021559	10	2080107	94	2090714	95
1530201	56	2020108	89	2020713	93	2060402	191	2080108	94	2090715	95
1530210	56	2020109	89	2020714	93	2060403	191	2080109	94	2090716	95
1530211	56	2020110	89	2020715	93	2060404	191	2080201	89	2090717	95
1530220	56	2020114	89	2020716	93	2060405	191	2080202	89	2090718	95
1530222	56	2020115	89	2020717	93	2060406	191	2080203	89	2090719	95
1530230	56	2020116	89	2020718	93	2060407	191	2080301	89	2090720	95
1530310	55	2020401	89	2020719	93	2070101	91	2080302	89	2090721	95
1990101	78	2020402	89	2020720	93	2070102	91	2080303	89	2090722	95
1990102	78	2020403	89	2020801	94	2070103	92	2080304	89	2090723	95
1990103	78	2020404	89	2020802	94	2070104	92	2080401	31	2090803	95
2000101	98	2020406	89	2020807	94	2070105	91	2080402	31	2090804	95
2000103	98	2020407	89	2020808	94	2070106	91	2080403	31	2090805	95
2000104	98	2020408	89	2020809	94	2070107	92	2080501	31	2090806	95
2000105	98	2020409	89	2020810	94	2070108	92	2080502	31	2090807	96
2000110	98	2020411	89	2020901	84	2070109	91	2080701	85	2090808	96
2000112	98	2020412	89	2020902	84	2070110	92	2080702	85	2090823	96
2000113	98	2020413	89	2021001	94	2070111	92	2080703	85	2090901	96
2000114	98	2020414	89	2021004	94	2070112	92	2080801	168	2090902	96
2000120	98	2020416	89	2021006	98	2070120	91	2080802	168	2090903	96
2000122	98	2020417	89	2021007	86	2070121	91	2080906	102	2090904	96
2000123	98	2020418	89	2021010	25	2070122	91	2081102	139	2090905	96
2000124	98	2020419	89	2021011	25	2070123	91	2081110	139	2090906	96
2000130	98	2020501	94	2021020	168	2070124	91	2090101	93	2091002	96
2000132	98	2020502	94	2021101	160	2070125	91	2090102	93	2091003	96

INDICE DE CODIGOS

2091004	96	2091701	97	2100803	47	2110510	43	2126221	193	2127132	77
2091005	96	2091702	97	2100804	47	2110511	43	2126401	191	2127133	77
2091006	96	2091703	97	2100805	47	2110601	238	2126402	191	2127134	77
2091007	96	2091704	97	2100806	47	2110602	238	2126403	191	2127135	77
2091008	96	2091900	97	2101102	47	2110603	238	2126410	31	2127151	134
2091009	96	2091903	97	2101103	47	2110604	238	2126440	88	2127152	134
2091010	96	2091904	97	2101201	47	2110605	238	2126441	88	2127153	134
2091011	96	2091905	97	2101202	47	2110606	238	2126442	88	2127157	134
2091012	96	2091906	97	2101203	47	2110901	119	2126443	88	2127158	134
2091013	96	2092001	98	2101204	47	2110901	200	2127001	45	2127159	134
2091014	96	2092002	98	2101401	47	2110902	119	2127002	45	2127180	134
2091015	96	2092003	98	2101402	47	2110902	200	2127003	45	2127181	134
2091016	96	2092004	98	2101701	46	2110903	119	2127004	45	2127182	134
2091017	96	2092101	17	2101702	46	2110903	200	2127005	45	2127183	134
2091018	96	2092102	17	2101705	46	2120100	163	2127006	45	2128001	190
2091019	96	2092105	17	2101803	46	2120101	163	2127007	45	2128002	190
2091020	96	2092106	17	2101901	48	2120102	163	2127008	45	2128003	190
2091021	96	2092107	17	2110116	43	2120103	163	2127009	45	2128004	190
2091022	96	2092108	17	2110117	43	2120105	163	2127010	45	2128005	190
2091023	96	2092404	99	2110118	43	2120106	163	2127011	45	2128006	190
2091100	96	2092405	99	2110119	43	2120107	163	2127012	45	2128007	190
2091102	96	2092407	99	2110120	43	2120110	163	2127013	45	2128008	190
2091103	96	2092408	99	2110121	43	2120111	163	2127014	45	2128009	190
2091104	96	2092410	99	2110123	43	2120112	163	2127015	45	2130101	167
2091105	96	2092411	99	2110124	43	2120113	163	2127016	45	2130102	167
2091106	96	2092413	99	2110125	43	2120114	163	2127020	41	2130103	167
2091107	96	2092414	99	2110126	43	2120401	163	2127021.	41	2130106	167
2091108	96	2092415	99	2110127	43	2120402	163	2127022	41	2130107	167
2091201	96	2092416	99	2110128	43	2120403	163	2127023	41	2130110	167
2091202	96	2092420	99	2110130	43	2120404	163	2127024	41	2130111	167
2091203	96	2092421	99	2110131	43	2120420	163	2127025	41	2130120	167
2091204	96	2092500	99	2110132	43	2120421	163	2127026	41	2130125	167
2091205	96	2092504	99	2110133	43	2120422	163	2127030	92	2130130	167
2091206	96	2092505	99	2110134	43	2120423	163	2127031	92	2145050	167
2091301	97	2092507	99	2110135	43	2120810	190	2127050	105	2145051	167
2091302	97	2092508	99	2110215	43	2120905	35	2127051	105	2145052	167
2091303	97	2092510	99	2110216	43	2120906	35	2127052	105	2145054	167
2091304	97	2092511	99	2110218	43	2121005	35	2127053	105	2150101	139
2091305	97	2093050	84	2110219	43	2121006	35	2127054	105	2150103	139
2091306	97	2093051	84	2110220	43	2122004	168	2127055	105	2150104	139
2091401	97	2093054	84	2110221	43	2122005	168	2127056	105	2150201	167
2091402	97	2093055	84	2110222	43	2122006	168	2127060	40	2150202	167
2091403	97	2095201	99	2110223	43	2122501	31	2127061	40	2150203	167
2091404	97	2095202	99	2110225	43	2122502	31	2127062	40	2150207	168
2091500	97	2095203	99	2110226	43	2123040	31	2127070	41	2160102	120
2091502	97	2095204	99	2110227	43	2123041	31	2127081	34	2170250	167
2091503	97	2095205	99	2110228	43	2125601	185	2127082	34	2170501	38
2091504	97	2095206	99	2110229	43	2125602	185	2127083	34	2170502	38
2091505	97	2095207	99	2110230	43	2125603	185	2127084	34	2170503	38
2091506	97	2095208	99	2110232	43	2125901	83	2127085	34	2170504	38
2091601	97	2095220	99	2110233	43	2126200	193	2127120	197	2170506	38
2091602	97	2095230	99	2110234	43	2126201	193	2127121	197	2170507	38
2091603	97	2095231	99	2110235	43	2126202	193	2127122	197	2170508	38
2091604	97	2095240	99	2110504	43	2126203	193	2127123	197	2170509	38
2091605	97	2095241	99	2110505	43	2126210	193	2127130	77	2170510	38
2091606	97	2095242	99	2110506	43	2126220	193	2127131	77	2170511	39

INDICE DE CODIGOS

2170512	39	2200109	101	2200748	146	2220118	141	2230116	196	2250141	1
2170513	39	2200110	101	2200749	146	2220150	141	2230117	196	2250144	1
2190101	199	2200111	101	2200750	146	2220151	141	2230121	196	2250145	1
2190102	199	2200112	101	2200751	146	2220152	141	2230122	196	2250160	1
2190103	199	2200113	101	2200760	142	2220201	141	2230123	196	2250161	1
2190104	199	2200114	101	2200761	142	2220202	141	2230130	196	2250162	1
2190201	199	2200115	101	2201001	29	2220203	141	2230131	196	2250170	1
2190202	199	2200116	101	2201002	29	2220204	141	2230132	196	2250203	2
2190203	199	2200117	101	2201003	29	2220205	141	2230133	196	2250204	2
2190204	199	2200118	101	2201011	29	2220206	141	2230134	196	2250211	2
2190205	199	2200150	101	2201012	29	2220207	141	2230135	196	2250212	2
2190206	199	2200201	101	2201013	29	2220208	141	2230150	196	2250240	2
2190301	199	2200202	101	2201020	29	2220250	141	2230151	196	2250241	2
2190302	199	2200203	101	2201021	29	2220251	141	2230152	196	2250246	2
2190310	201	2200207	101	2201211	19	2220303	197	2230155	196	2250247	2
2190311	201	2200208	101	2201212	19	2220304	197	2230156	196	2250250	2
2190320	201	2200209	101	2201213	19	2220305	197	2230157	196	2250260	2
2190401	137	2200230	101	2201214	19	2220306	195	2230158	196	2250262	2
2190402	137	2200231	101	2201215	19	2220307	195	2230159	196	2250263	2
2190404	137	2200301	48	2201216	19	2220308	195	2230160	196	2250301	3
2190405	137	2200303	48	2201217	19	2220309	195	2230211	196	2250303	3
2190501	51	2200310	48	2201218	19	2220310	198	2230212	196	2250305	3
2190502	51	2200311	48	2201240	31	2220311	198	2230213	196	2250307	3
2190503	51	2200314	48	2201241	31	2220350	195	2230215	196	2250320	3
2190504	51	2200315	48	2201501	137	2220351	195	2230217	196	2250322	3
2190505	51	2200401	146	2201502	137	2220352	195	2230220	196	2250324	3
2190506	51	2200403	146	2201503	137	2220353	195	2230221	196	2250326	3
2190507	51	2200404	146	2201504	137	2220354	195	2230251	196	2250330	3
2190508	51	2200405	146	2201550	47	2220401	90	2230252	196	2250332	3
2190509	51	2200406	146	2210310	197	2220402	90	2230253	196	2250352	17
2190901	222	2200407	146	2210311	197	2220403	90	2230255	196	2250354	17
2190902	222	2200408	146	2210506	139	2220404	90	2230256	196	2250356	17
2190903	222	2200507	103	2210702	146	2220405	90	2230257	196	2250360	18
2190904	222	2200508	103	2210703	146	2220406	90	2230258	196	2250361	18
2190905	222	2200703	140	2210704	146	2220407	90	2232001	196	2250370	18
2190906	222	2200704	140	2210705	146	2220408	90	2232010	196	2250372	18
2190907	222	2200705	140	2212010	140	2220409	90	2235020	197	2250374	17
2190908	222	2200706	140	2212050	142	2221501	91	2235021	197	2250380	18
2190910	222	2200707	140	2212051	142	2221502	91	2235022	197	2250382	18
2190912	222	2200708	140	2220101	141	2221503	91	2235023	197	2250384	18
2190920	222	2200713	68	2220102	141	2221504	91	2235024	197	2250386	18
2191001	31	2200714	68	2220103	141	2221508	91	2237001	196	2250392	17
2191002	31	2200715	68	2220104	141	2221509	91	2237002	196	2250394	17
2191003	31	2200716	68	2220105	141	2221510	91	2237003	196	2250396	17
2191004	31	2200717	68	2220106	141	2221511	91	2237006	196	2250428	2
2191005	31	2200719	119	2220107	141	2221520	91	2237021	196	2250429	2
2191006	31	2200720	119	2220108	141	2221521	91	2237022	196	2250433	2
2199001	199	2200740	146	2220109	141	2221522	91	2237023	196	2250434	2
2199002	199	2200741	146	2220110	140	2221523	91	2240103	192	2250435	2
2199003	199	2200742	146	2220111	140	2230101	196	2240104	192	2250436	2
2199010	167	2200743	146	2220112	140	2230102	196	2240105	192	2250439	2
2200104	101	2200745	120	2220113	141	2230103	196	2240106	192	2250440	2
2200105	101	2200745	200	2220114	141	2230110	196	2240107	192	2250441	3
2200106	101	2200746	120	2220115	141	2230111	196	2250122	1	2250442	3
2200107	101	2200746	200	2220116	141	2230112	196	2250123	1	2250501	13
2200108	101	2200747	146	2220117	141	2230113	196	2250140	1	2250502	13

INDICE DE CODIGOS

2250505	13	2250670	14	2280123	44	2353351	48	2360464	145	2380014	147
2250506	13	2250671	14	2280124	44	2353352	48	2360465	145	2380015	147
2250507	13	2250672	14	2280125	44	2353353	48	2360466	145	2380016	147
2250508	13	2250674	14	2280126	44	2353354	48	2360467	145	2380050	147
2250510	13	2250680	14	2280127	44	2353360	103	2360468	145	2380051	147
2250511	13	2250681	14	2280128	44	2353361	103	2360469	145	2380052	147
2250521	13	2250684	13	2280129	44	2353367	126	2360470	145	2380053	147
2250522	13	2250685	13	2290200	2	2353370	126	2360501	47	2380054	147
2250525	13	2250688	13	2290201	2	2353371	126	2360502	48	2380055	147
2250526	13	2250690	13	2290202	2	2353372	126	2360503	48	2380056	147
2250527	13	2250692	13	2290203	2	2353430	114	2370201	41	2380057	147
2250528	13	2250693	13	2291001	87	2353431	114	2370204	41	2380058	147
2250530	13	2250701	203	2291002	87	2353432	114	2370301	34	2380059	147
2250541	13	2250702	203	2291003	87	2353433	114	2370302	34	2380060	147
2250542	13	2250721	17	2291004	87	2353434	114	2370303	34	2380061	147
2250545	13	2250730	18	2291008	87	2353435	114	2370304	34	2380062	147
2250546	13	2250732	18	2291009	87	2353436	114	2370306	34	2380063	147
2250547	13	2250801	98	2291010	87	2353437	114	2370307	34	2380064	147
2250548	13	2250803	98	2291011	87	2353439	121	2370308	34	2380065	147
2250550	13	2251001	28	2291012	87	2353440	122	2370350	34	2380102	147
2250560	14	2251002	28	2291013	87	2353445	122	2370351	34	2380103	147
2250561	14	2251003	28	2291014	87	2353450	136	2370352	34	2380104	147
2250562	14	2251010	28	2291015	87	2353453	138	2370353	34	2380105	147
2250564	14	2251011	28	2301001	136	2353455	138	2370354	34	2380107	147
2250570	14	2251012	28	2301002	136	2353456	138	2370355	34	2380108	147
2250571	14	2251015	28	2301003	136	2353457	138	2370356	34	2380110	147
2250572	14	2251016	28	2301004	136	2353471	138	2370407	33	2380111	147
2250574	14	2251017	28	2301010	31	2353472	138	2370408	33	2380112	147
2250575	14	2251020	28	2303001	36	2353473	138	2370421	33	2380113	147
2250576	14	2251021	28	2303002	36	2354040	137	2370423	33	2380114	147
2250577	14	2251022	28	2303003	36	2354043	137	2370426	33	2380115	147
2250601	13	2251025	28	2330101	40	2354100	115	2370428	33	2380116	147
2250602	13	2251026	28	2330105	40	2354102	115	2370501	34	2380119	147
2250605	13	2251027	28	2351220	139	2360101	119	2370502	34	2380121	147
2250606	13	2280101	44	2352324	138	2360101	200	2371004	34	2380123	147
2250607	13	2280102	44	2352338	138	2360102	119	2371005	34	2380302	147
2250608	13	2280103	44	2352392	138	2360102	200	2371023	34	2380303	147
2250610	13	2280104	44	2353187	28	2360103	119	2371024	34	2380304	147
2250621	13	2280105	44	2353188	28	2360103	200	2371101	51	2380305	147
2250622	13	2280106	44	2353189	28	2360205	191	2371102	51	2380307	147
2250625	13	2280107	44	2353191	28	2360350	103	2371111	51	2380308	147
2250626	13	2280108	44	2353192	28	2360401	145	2371501	35	2380310	147
2250627	13	2280109	44	2353194	28	2360450	145	2371510	35	2380311	147
2250628	13	2280110	44	2353195	28	2360451	145	2380001	147	2380312	147
2250629	13	2280111	44	2353196	28	2360452	145	2380002	147	2380313	147
2250641	13	2280112	44	2353290	48	2360453	145	2380003	147	2380314	147
2250642	13	2280113	44	2353291	48	2360454	145	2380004	147	2380315	147
2250645	13	2280114	44	2353299	22	2360455	145	2380005	147	2380316	147
2250646	13	2280115	44	2353322	140	2360456	145	2380006	147	2380319	147
2250647	13	2280116	44	2353323	140	2360457	145	2380007	147	2380321	147
2250648	13	2280117	44	2353324	140	2360458	145	2380008	147	2380322	147
2250650	13	2280118	44	2353325	140	2360459	145	2380009	147	2380323	147
2250655	14	2280119	44	2353326	140	2360460	145	2380010	147	2380601	148
2250656	14	2280120	44	2353327	140	2360461	145	2380011	147	2380602	148
2250657	14	2280121	44	2353332	139	2360462	145	2380012	147	2380603	148
2250660	14	2280122	44	2353337	139	2360463	145	2380013	147	2380604	148

INDICE DE CODIGOS

2380701	148	2381901	149	2382418	155	2383121	155	2383510	159	2384701	109
2380702	148	2381902	149	2382419	155	2383301	160	2383801	160	2384702	109
2380703	148	2381906	149	2382420	155	2383305	157	2383802	160	2384703	109
2380704	148	2381907	149	2382421	155	2383306	157	2383803	160	2384704	109
2380705	148	2381908	149	2382424	155	2383308	157	2383804	160	2384706	109
2380706	148	2382001	148	2382425	155	2383310	157	2383806	160	2384707	109
2380707	148	2382002	148	2382430	155	2383311	157	2383807	160	2384709	109
2380708	148	2382003	148	2382501	155	2383312	157	2383808	160	2384714	109
2380801	148	2382004	148	2382502	155	2383314	157	2383809	160	2384806	109
2380802	148	2382101	150	2382530	155	2383315	157	2383810	160	2384807	109
2380803	148	2382102	150	2382531	155	2383316	157	2383811	160	2384808	109
2380901	149	2382103	150	2382601	155	2383318	157	2383812	160	2384902	109
2380902	149	2382104	150	2382602	155	2383319	157	2383813	160	2384904	109
2380903	149	2382110	150	2382629	155	2383320	157	2383901	160	2384906	109
2380904	149	2382112	150	2382630	155	2383321	157	2383902	160	2385401	181
2380905	149	2382114	150	2382631	155	2383322	157	2383903	160	2385402	181
2380906	149	2382116	150	2382638	155	2383401	159	2383904	160	2385403	181
2380907	149	2382205	150	2382639	155	2383402	159	2383905	160	2385404	181
2380908	149	2382206	150	2382640	155	2383403	159	2383906	160	2385405	181
2380909	149	2382207	150	2382901	156	2383404	159	2384001	160	2385406	181
2381001	148	2382208	150	2382902	156	2383405	159	2384002	160	2385407	181
2381002	148	2382209	150	2382903	156	2383409	159	2384004	160	2385408	181
2381003	148	2382212	150	2382904	156	2383410	159	2384005	160	2385409	181
2381010	148	2382213	150	2382905	156	2383411	159	2384006	160	2385410	181
2381011	148	2382301	155	2382907	156	2383412	159	2384007	160	2385411	181
2381012	148	2382302	155	2382908	156	2383413	159	2384008	160	2385414	182
2381101	147	2382303	155	2382909	156	2383414	159	2384009	160	2385415	182
2381102	147	2382305	155	2382911	156	2383415	159	2384010	160	2385416	182
2381103	147	2382306	155	2382912	156	2383416	159	2384011	160	2385510	152
2381104	147	2382307	155	2382913	156	2383417	159	2384012	160	2385512	152
2381105	147	2382308	155	2382914	156	2383418	159	2384013	160	2386005	149
2381106	147	2382309	155	2382915	156	2383419	159	2384014	160	2386006	149
2381107	147	2382310	155	2382916	156	2383420	159	2384015	160	2386007	149
2381108	148	2382311	155	2382918	156	2383421	159	2384040	130	2386008	149
2381109	148	2382313	155	2382919	161	2383422	159	2384041	130	2386009	149
2381110	148	2382314	155	2382919	156	2383423	159	2384044	161	2386010	149
2381111	148	2382315	155	2382930	156	2383424	159	2384045	130	2386011	149
2381112	148	2382316	155	2382933	156	2383425	159	2384045	159	2389936	130
2381113	148	2382317	155	2383001	156	2383426	159	2384045	161	2389940	161
2381301	147	2382318	155	2383002	156	2383427	159	2384046	130	2389941	161
2381302	147	2382319	155	2383003	156	2383428	159	2384046	161	2389942	161
2381303	147	2382320	155	2383004	156	2383450	159	2384047	130	2389950	161
2381304	147	2382321	155	2383005	156	2383451	159	2384047	161	2389951	161
2381305	147	2382350	157	2383006	156	2383452	159	2384049	130	2389952	161
2381306	147	2382351	157	2383102	156	2383453	159	2384049	161	2389953	161
2381307	147	2382352	157	2383104	156	2383499	159	2384050	130	2389954	161
2381308	148	2382353	157	2383105	156	2383500	159	2384050	161	2389970	153
2381309	148	2382354	157	2383111	155	2383501	159	2384052	130	2389971	153
2381310	148	2382404	155	2383112	155	2383502	159	2384052	161	2400101	90
2381311	148	2382405	155	2383113	157	2383503	159	2384063	159	2400102	90
2381312	148	2382407	155	2383114	155	2383504	159	2384063	161	2400103	90
2381313	148	2382408	155	2383115	155	2383505	159	2384064	161	2400104	90
2381601	148	2382411	155	2383116	155	2383506	159	2384065	161	2400105	90
2381602	148	2382412	155	2383117	155	2383507	159	2384066	161	2400106	90
2381603	148	2382415	155	2383119	155	2383508	159	2384067	161	2400107	90
2381801	148	2382416	155	2383120	155	2383509	159	2384068	161	2400108	90

INDICE DE CODIGOS

2400201	91	2400532	19	2410217	33	2410742	38	2432702	92	2490332	29
2400202	91	2400533	19	2410218	33	2410743	38	2432703	92	2490601	31
2400203	91	2400534	19	2410221	34	2410744	38	2433010	19	2490602	31
2400204	91	2400535	19	2410222	34	2410745	38	2433011	19	2490603	31
2400205	91	2400536	19	2410227	33	2410752	94	2433315	19	2490604	31
2400206	91	2400537	19	2410228	33	2410753	94	2433316	19	2490605	31
2400207	91	2400601	94	2410231	34	2410771	160	2433601	85	2490606	31
2400208	91	2400603	94	2410232	34	2410772	160	2433602	85	2490901	47
2400301	91	2400610	94	2410235	33	2410801	84	2433603	85	2490902	47
2400302	91	2400611	94	2410236	33	2410802	84	2433801	89	2490903	47
2400303	91	2400701	83	2410239	34	2410803	84	2433802	89	2490904	47
2400304	91	2400702	83	2410240	34	2420102	121	2433803	89	2490905	47
2400305	91	2400703	83	2410244	33	2420105	121	2433804	89	2490906	47
2400306	91	2400704	83	2410250	34	2420108	121	2434003	176	2490907	47
2400307	91	2400705	83	2410251	34	2420140	122	2434004	203	2490908	47
2400308	91	2400706	83	2410256	51	2420140	138	2434004	176	2491101	103
2400401	83	2400707	83	2410257	51	2420141	122	2434101	191	2491102	103
2400402	83	2400708	83	2410309	35	2420141	138	2434102	191	2491103	103
2400403	83	2400710	83	2410321	35	2420142	122	2434112	189	2491104	103
2400404	83	2400711	83	2410336	35	2420142	138	2434501	84	2491105	103
2400405	83	2400712	83	2410350	35	2420143	122	2434503	84	2491106	103
2400406	83	2400713	83	2410351	35	2420143	138	2440101	41	2491107	103
2400407	83	2401001	85	2410353	35	2420150	137	2440102	41	2491108	103
2400408	83	2401002	85	2410361	35	2420151	137	2440103	41	2491109	103
2400410	83	2401004	85	2410366	35	2420155	137	2440104	41	2491110	103
2400411	83	2410101	38	2410500	83	2420156	137	2440105	41	2491501	83
2400412	83	2410103	38	2410501	83	2420157	137	2440201	41	2491502	83
2400413	83	2410104	38	2410504	83	2420158	137	2440202	41	2491601	83
2400415	83	2410109	38	2410513	101	2420160	121	2440203	41	2491602	83
2400416	83	2410110	38	2410514	101	2420161	121	2440301	42	2491603	83
2400417	83	2410111	38	2410702	37	2420207	141	2440302	42	2491604	83
2400418	83	2410112	38	2410703	37	2430701	63	2440303	42	2491605	83
2400420	84	2410113	38	2410705	37	2430703	63	2441101	41	2492032	3
2400421	84	2410114	38	2410706	37	2430901	63	2441102	41	2492101	85
2400422	84	2410115	38	2410708	37	2430902	63	2441103	41	2492102	85
2400423	84	2410116	38	2410709	37	2431001	17	2441104	41	2492131	85
2400427	84	2410117	38	2410711	37	2431002	17	2441105	41	2492132	85
2400501	19	2410118	38	2410712	37	2431003	17	2441201	41	2492501	189
2400502	19	2410119	37	2410714	37	2431004	17	2441202	41	2492601	193
2400503	19	2410122	37	2410715	37	2431301	191	2441203	41	2492602	193
2400504	19	2410125	37	2410717	37	2431303	191	2441301	42	2492603	193
2400505	19	2410126	37	2410718	37	2431701	84	2441302	42	2492631	193
2400506	19	2410127	37	2410720	37	2431702	84	2441303	42	2492632	193
2400507	19	2410128	37	2410721	37	2431703	84	2450002	131	2492633	193
2400508	19	2410129	37	2410723	37	2431704	84	2450050	131	2493001	86
2400509	84	2410130	37	2410724	37	2431706	84	2450090	159	2493002	86
2400511	19	2410131	37	2410726	37	2431707	84	2450091	160	2493031	86
2400512	19	2410134	37	2410727	37	2432501	86	2450092	160	2493032	86
2400515	19	2410135	37	2410729	37	2432504	86	2450093	160	2493201	185
2400516	19	2410136	37	2410730	37	2432506	86	2470101	195	2493231	185
2400519	19	2410137	37	2410732	37	2432507	86	2470102	195	2493403	175
2400520	19	2410138	37	2410733	37	2432510	86	2470103	196	2493433	175
2400521	19	2410202	33	2410735	37	2432511	86	2470104	196	2493503	175
2400522	19	2410204	33	2410736	37	2432601	91	2490301	29	2493505	175
2400530	19	2410205	33	2410740	85	2432602	91	2490302	29	2493507	175
2400531	19	2410206	33	2410741	85	2432701	92	2490331	29	2493508	175

INDICE DE CODIGOS

2493533	175	2500601	5	2502104	6	2520103	179	2520178.	180	2570101	153
2493535	175	2500603	5	2502201	6	2520104	179	2520179	180	2570103	153
2493537	175	2500605	5	2502207	6	2520105	179	2520180	180	2570110	153
2493538	175	2500702	5	2502215	6	2520106	179	2520181	180	2570115	153
2499907	1	2500753	7	2502250	6	2520107	179	2520182	180	2570116	153
2499908	1	2500762	6	2502253	6	2520108	179	2520183	180	2570117	153
2499909	1	2500764	6	2502255	6	2520109	179	2520184	180	2570120	153
2499910	1	2500780	5	2502280	7	2520110	179	2520185	180	2570121	153
2499911	1	2500782	5	2502283	7	2520111	179	2520186	180	2590101	185
2499912	1	2500784	4	2502284	7	2520112	179	2520187	180	2590107	185
2499922	2	2500792	5	2502302	5	2520113	179	2520188	180	2590108	185
2499923	2	2500803	6	2502304	5	2520114	179	2520189	180	2590119	185
2500101	3	2500804	6	2502306	5	2520115	179	2520201	180	2590120	185
2500102	3	2500805	6	2502402	4	2520116	179	2520202	180	2590122	185
2500103	18	2500820	6	2502406	4	2520117	179	2520203	180	2590123	185
2500104	17	2500826	6	2502412	4	2520118	179	2520204	180	2590133	185
2500150	3	2500827	6	2502416	4	2520119	179	2520205	180	2590134	185
2500151	3	2500855	6	2502811	15	2520120	179	2520206	180	2590140	185
2500181	2	2500901	6	2502821	8	2520121	179	2520207	181	2590142	185
2500183	2	2500902	6	2502824	8	2520122	179	2520208	181	2590144	185
2500210	18	2500903	6	2502826	8	2520123	179	2520210	181	2590145	186
2500211	18	2500910	7	2502827	8	2520124	179	2520211	181	2590146	186
2500220	51	2500911	7	2502829	8	2520125	179	2520213	181	2590151	186
2500221	51	2500912	7	2502830	8	2520126	179	2520214	181	2590152	186
2500222	51	2500930	4	2502831	8	2520127	179	2520215	181	2590153	186
2500223	51	2500932	4	2502832	8	2520128	179	2520217	181	2590169	186
2500224	51	2500934	4	2502835	8	2520129	179	2520218	181	2590170	186
2500225	51	2501001	5	2502836	8	2520130	179	2520219	181	2590171	186
2500232	2	2501002	5	2502838	8	2520131	179	2520221	181	2590172	186
2500233	2	2501004	5	2502841	8	2520132	179	2520222	181	2590175	186
2500252	85	2501060	15	2502843	8	2520135	179	2520223	181	2590176	186
2500255	51	2501068	15	2502844	8	2520136	179	2520224	181	2590177	186
2500256	51	2501072	15	2502845	8	2520137	179	2520225	181	2590178	186
2500257	51	2501101	4	2502846	8	2520138	180	2520226	181	2600101	168
2500258	51	2501102	4	2502850	8	2520139	180	2520227	181	2600102	168
2500322	203	2501103	4	2502853	8	2520140	180	2520228	181	2600103	168
2500401	163	2501301	5	2502858	8	2520141	180	2520303	182	2600105	168
2500402	163	2501302	5	2502859	8	2520142	180	2520304	182	2600106	168
2500403	163	2501303	5	2503501	7	2520143	180	2520308	182	2600107	168
2500404	163	2501311	5	2503502	7	2520144	180	2520309	182	2600108	168
2500405	163	2501313	5	2503503	7	2520146	180	2520310	182	2600109	168
2500406	163	2501608	5	2503511	7	2520147	180	2520311	182	2600110	168
2500407	163	2501610	5	2505001	10	2520148	180	2520312	182	2600150	168
2500408	163	2501612	5	2505004	10	2520149	180	2520313	182	2600151	168
2500410	163	2501650	15	2505006	10	2520151	180	2520314	182	2600152	168
2500411	163	2501652	15	2505305	10	2520152	180	2520315	182	2600154	168
2500412	163	2501850	14	2505308	10	2520153	180	2520316	182	2600157	168
2500413	163	2501852	14	2505311	10	2520154	180	2520317	182	2600158	168
2500414	163	2501860	14	2505320	10	2520170	180	2520601	183	2600201	167
2500415	163	2501872	14	2505401	7	2520171	180	2520603	183	2600202	167
2500452	6	2501902	6	2505402	7	2520172	180	2520605	183	2600203	167
2500501	5	2501904	6	2505403	7	2520173	180	2520607	183	2600220	168
2500502	5	2501906	6	2515050	159	2520174	180	2520609	183	2600221	168
2500503	5	2501916	6	2515051	159	2520175	180	2520611	183	2600222	168
2500520	5	2501918	6	2515055	159	2520176	180	2540120	186	2600225	168
2500525	5	2502102	6	2520102	179	2520177	180	2540121	186	2600226	168

INDICE DE CODIGOS

2600227	168	2660012	138	2700105	39	2990011	192	3011512	146	3060206	136
2600229	168	2660013	138	2700106	39	2991000	192	3011513	146	3060210	136
2600235	167	2660014	138	2700201	39	2991001	192	3011514	146	3060211	136
2600252	167	2660101	198	2700202	39	2992002	192	3011515	146	3060301	1
2600253	167	2660102	198	2700203	39	2992003	192	3011516	146	3060302	1
2600254	167	2660103	198	2700204	39	2993504	138	3012400	18	3060303	1
2600255	167	2660104	198	2700205	39	2993505	138	3012401	18	3060310	1
2600256	167	2660105	198	2700206	39	2993506	138	3012402	18	3060311	1
2600302	167	2660106	198	2700301	39	2993507	138	3012403	18	3060312	1
2600310	169	2660107	198	2700302	39	2993508	138	3012404	18	3060320	1
2600314	167	2660108	198	2700315	105	2993509	138	3012405	18	3060321	1
2600315	167	2660110	198	2700319	92	2993510	138	3012406	18	3060322	1
2600316	167	2690101	11	2700320	92	2993511	138	3012407	18	3060330	1
2600325	169	2690102	11	2700321	92	3000301	121	3020101	29	3060331	1
2600326	169	2690104	11	2700322	92	3000302	121	3020102	29	3060332	1
2600373	169	2690105	11	2700330	92	3000303	187	3020103	29	3060335	1
2600374	169	2690107	11	2700331	92	3000303	121	3020104	29	3060336	1
2600375	169	2690108	11	2700334	92	3000320	121	3020105	29	3060337	1
2600376	169	2690114	10	2700335	92	3000320	187	3020106	29	3061001	189
2600377	169	2690115	10	2700336	92	3000321	121	3020107	29	3061002	189
2600378	169	2690116	10	2700341	192	3000321	187	3020108	29	3070101	177
2620101	168	2690117	10	2700401	39	3000322	121	3020501	29	3070102	177
2620102	168	2690123	10	2700402	39	3000322	187	3020502	29	3070103	119
2620103	168	2690124	10	2700403	39	3010120	27	3020503	29	3070103	119
2620111	167	2690125	10	2700603	38	3010121	27	3020504	29	3070103	177
2620116	167	2690126	10	2700604	38	3010122	27	3020505	29	3070103	177
2620116	169	2690127	10	2700630	39	3010123	27	3020506	29	3070501	119
2620118	167	2690142	11	2700631	39	3010124	27	3031000	116	3070503	119
2620118	169	2690143	11	2710101	116	3010125	27	3031001	116	3070505	119
2630010	190	2690150	11	2710102	116	3010220	39	3031002	116	3071004	119
2630013	191	2690151	11	2710103	116	3010225	85	3031003	116	3071006	119
2630015	191	2690152	11	2710104	116	3010226	85	3031010	116	3071010	119
2630027	190	2690153	11	2710105	116	3010227	85	3031020	116	3071012	119
2630050	189	2690157	11	2710106	116	3010250	31	3031030	116	3071014	119
2630051	189	2690158	11	2720180	153	3010251	31	3031040	116	3080702	47
2630052	189	2690159	11	2790116	169	3010301	19	3031041	116	3081102	119
2640101	199	2690160	99	2790117	169	3010302	19	3042501	48	3081103	119
2640102	199	2690160	11	2911002	122	3010303	19	3042503	48	3081105	119
2640103	199	2690161	99	2960505	2	3010304	19	3042504	48	3081106	119
2640106	199	2690161	11	2960601	31	3010314	189	3042508	48	3081108	119
2650101	17	2690162	99	2960602	31	3010315	189	3042509	48	3081109	119
2650102	17	2690162	11	2960603	31	3010316	189	3042510	48	3081111	119
2650201	145	2690163	11	2960610	31	3010317	189	3042511	48	3081112	119
2650202	145	2690164	11	2960611	31	3010324	19	3042601	48	3081205	102
2650203	145	2690165	11	2960612	31	3010325	19	3042603	48	3081206	102
2650301	197	2690172	99	2960613	31	3010326	19	3042604	48	3081207	102
2650302	197	2690172	11	2960614	31	3010327	19	3042701	46	3081208	102
2650303	197	2690173	99	2960615	31	3010328	19	3043404	145	3081301	102
2650304	145	2690173	11	2960701	193	3010329	19	3043405	145	3081401	102
2650305	145	2690174	11	2960702	193	3011501	146	3043406	145	3081402	102
2650306	145	2690174	99	2960708	193	3011502	146	3043600	47	3081403	102
2650310	197	2690201	11	2960709	193	3011503	146	3043601	47	3081404	102
2650311	197	2700101	39	2960710	193	3011504	146	3043602	47	3081504	102
2650312	197	2700102	39	2960711	193	3011505	146	3060201	136	3081513	102
2660010	138	2700103	39	2990007	192	3011506	146	3060202	136	3081514	102
2660011	138	2700104	39	2990010	192	3011511	146	3060205	136	3081516	102

INDICE DE CODIGOS

3081601	189	3090263	24	3110317	133	3170435	25	3170548	21	3170674	21
3081602	189	3090264	24	3110318	133	3170436	25	3170549	21	3170676	21
3081603	189	3090265	24	3110319	133	3170437	25	3170565	22	3170677	21
3081604	189	3090266	24	3110501	133	3170440	25	3170566	22	3170679	21
3090060	23	3090267	24	3110502	133	3170441	25	3170567	22	3170680	21
3090061	23	3090268	24	3110503	133	3170442	25	3170568	22	3170682	21
3090062	23	3100201	26	3110504	133	3170443	25	3170569	22	3170683	21
3090063	23	3100202	26	3110505	133	3170444	25	3170570	22	3180105	131
3090064	23	3100203	26	3110601	133	3170445	25	3170580	22	3180105	162
3090101	23	3100204	26	3110602	133	3170446	25	3170581	22	3180106	131
3090102	23	3100205	26	3110603	133	3170450	22	3170582	22	3180106	162
3090103	23	3100206	26	3110604	133	3170451	22	3170583	22	3200200	39
3090104	23	3100208	26	3110605	133	3170452	22	3170584	22	3200201	39
3090105	23	3100209	26	3110701	133	3170460	22	3170585	22	3200202	39
3090106	23	3100210	26	3110702	133	3170461	22	3170590	22	3200203	39
3090107	23	3100211	26	3110703	133	3170462	22	3170591	22	3200204	39
3090108	23	3100212	26	3110704	133	3170470	25	3170601	21	3200206	40
3090109	23	3100213	26	3110705	133	3170471	25	3170602	21	3200208	40
3090110	23	3100501	26	3110801	133	3170472	25	3170604	21	3200220	39
3090111	23	3100503	26	3110802	133	3170473	25	3170605	21	3200221	39
3090112	23	3100504	26	3110803	133	3170501	21	3170607	21	3200222	40
3090113	23	3100507	26	3110804	133	3170502	21	3170608	21	3200223	40
3090114	23	3100508	26	3110805	133	3170503	21	3170609	21	3200225	40
3090115	23	3100510	26	3110808	133	3170504	21	3170613	21	3200227	40
3090116	23	3100511	26	3112001	136	3170505	21	3170614	21	3200229	39
3090117	23	3100513	26	3112002	136	3170506	21	3170619	21	3200230	40
3090118	23	3101001	26	3115001	136	3170507	21	3170620	21	3200231	40
3090150	23	3101002	26	3115002	136	3170508	21	3170622	21	3200232	40
3090151	23	3101003	26	3115003	136	3170511	21	3170623	21	3200235	40
3090152	23	3101004	26	3115014	136	3170512	21	3170625	21	3200236	40
3090201	23	3101005	26	3116002	136	3170513	21	3170626	21	3200237	40
3090202	23	3101006	26	3116004	136	3170514	21	3170628	21	3200301	40
3090203	23	3101007	26	3116006	136	3170515	21	3170629	21	3200302	40
3090204	23	3101008	26	3116008	136	3170516	21	3170634	21	3200303	40
3090206	23	3101010	26	3116010	136	3170517	21	3170635	21	3200304	40
3090207	23	3101012	26	3116012	136	3170518	21	3170637	21	3200400	51
3090208	23	3101013	26	3120101	101	3170519	21	3170638	21	3200401	51
3090209	23	3101014	26	3120102	101	3170520	21	3170640	21	3200402	51
3090210	24	3101015	26	3120201	46	3170521	21	3170641	21	3200403	51
3090212	24	3101016	26	3120202	46	3170522	21	3170643	21	3200404	51
3090213	24	3101017	26	3120203	46	3170523	21	3170644	21	3200405	51
3090214	24	3101501	26	3140250	29	3170524	21	3170646	21	3200406	51
3090215	24	3101502	26	3140251	29	3170525	21	3170647	21	3200703	165
3090216	24	3101503	26	3150101	187	3170526	21	3170655	21	3200704	165
3090218	24	3101504	26	3150102	187	3170527	22	3170656	21	3201001	165
3090219	24	3101530	26	3150103	187	3170528	22	3170658	21	3201002	165
3090220	24	3101531	26	3150104	187	3170529	22	3170659	21	3201003	165
3090221	24	3101540	26	3160102	139	3170530	22	3170661	21	3201510	152
3090222	24	3101541	26	3160103	139	3170531	22	3170662	21	3201511	152
3090224	24	3110101	133	3160104	139	3170532	22	3170664	21	3201520	152
3090250	24	3110102	133	3160105	139	3170535	22	3170665	21	3201522	152
3090251	24	3110103	133	3160110	139	3170536	22	3170667	21	3201524	152
3090252	24	3110104	133	3170411	22	3170539	22	3170668	21	3201525	152
3090260	24	3110105	133	3170412	22	3170540	22	3170670	21	3201526	152
3090261	24	3110315	133	3170413	22	3170546	21	3170671	21	3201527	152
3090262	24	3110316	133	3170421	22	3170547	21	3170673	21	3201528	152

INDICE DE CODIGOS

3201530	152	3380101	86	3400192	118	3480110	44	3530350	46	3540145	142
3201532	152	3380102	86	3400194	118	3480111	44	3530351	46	3540145	206
3201534	152	3380301	141	3400195	118	3530101	44	3530352	46	3540146	142
3201535	152	3380302	141	3400196	118	3530102	44	3530353	46	3540146	206
3201536	152	3380303	141	3400201	115	3530105	44	3530354	46	3540147	142
3201537	152	3380304	142	3400203	111	3530106	44	3530355	46	3540147	206
3201538	152	3380305	142	3400204	111	3530107	44	3530356	46	3540150	142
3202001	172	3380306	142	3400205	111	3530108	44	3530357	46	3540150	205
3202002	172	3380307	142	3400206	111	3530109	44	3530402	41	3540151	142
3202011	41	3380404	86	3400207	111	3530110	44	3530411	41	3540151	205
3210101	108	3380406	86	3400208	111	3530111	44	3530412	41	3540152	142
3210104	108	3400101	107	3400209	111	3530112	44	3530413	41	3540152	205
3230000	129	3400102	107	3400210	111	3530113	44	3530501	162	3540153	142
3230001	129	3400103	107	3400211	111	3530119	44	3530502	162	3540153	205
3230004	129	3400104	107	3400212	111	3530120	44	3540104	205	3540154	142
3230005	129	3400105	107	3400213	111	3530121	44	3540105	205	3540154	205
3235001	131	3400106	107	3400217	111	3530122	44	3540106	205	3540155	142
3235002	131	3400107	107	3400218	111	3530124	45	3540110	205	3540155	205
3235080	119	3400108	107	3400219	111	3530125	45	3540111	205	3540156	142
3240250	53	3400109	107	3400220	111	3530126	45	3540112	205	3540156	205
3240255	53	3400110	107	3400221	111	3530127	45	3540115	205	3540157	142
3240301	101	3400111	107	3400222	111	3530128	45	3540116	205	3540157	205
3240302	101	3400112	107	3400223	111	3530129	45	3540117	205	3540158	142
3260101	84	3400113	107	3400224	111	3530131	45	3540118	205	3540158	205
3290101	130	3400114	107	3400225	115	3530132	45	3540119	205	3540159	142
3290102	130	3400115	107	3400226	115	3530133	45	3540120	205	3540159	205
3290103	130	3400116	107	3400227	115	3530134	45	3540121	205	3540160	206
3290104	130	3400121	107	3400228	115	3530135	45	3540122	205	3540161	206
3290105	130	3400122	107	3400229	115	3530140	45	3540123	205	3540162	206
3290106	130	3400123	107	3400230	108	3530141	45	3540124	205	3540163	206
3330401	20	3400130	114	3400231	110	3530142	45	3540125	205	3540165	205
3330402	20	3400131	114	3400232	108	3530143	45	3540126	205	3540166	205
3330403	20	3400132	114	3400233	110	3530150	45	3540127	205	3540167	205
3330404	20	3400133	114	3400234	108	3530151	45	3540128	206	3540168	205
3330410	20	3400140	108	3400235	110	3530152	45	3540130	141	3540169	205
3330411	20	3400141	108	3400236	108	3530153	45	3540130	205	3540170	205
3330412	20	3400161	115	3400237	110	3530160	45	3540131	141	3540180	206
3330413	20	3400163	115	3400238	108	3530161	45	3540131	205	3540181	206
3350101	102	3400170	117	3400239	110	3530162	45	3540132	141	3540182	206
3350102	102	3400171	117	3400240	108	3530163	45	3540132	205	3540183	206
3350110	102	3400174	117	3400241	110	3530234	45	3540133	141	3540502	195
3350111	102	3400175	117	3400250	108	3530235	45	3540133	205	3540503	195
3350112	102	3400176	117	3400251	108	3530236	45	3540134	141	3540504	195
3350113	102	3400177	117	3400260	114	3530237	45	3540134	205	3540505	195
3350114	102	3400180	117	3400261	114	3530301	46	3540135	141	3540601	199
3350115	102	3400181	117	3400262	114	3530302	46	3540135	205	3540602	199
3350116	102	3400182	117	3400268	110	3530303	46	3540140	142	3540701	195
3350118	102	3400183	117	3400270	108	3530304	46	3540140	205	3540702	195
3350205	201	3400184	117	3400284	110	3530305	46	3540141	142	3570101	44
3350212	201	3400185	117	3400285	108	3530306	46	3540141	205	3590102	56
3350214	201	3400186	117	3400310	110	3530307	46	3540142	142	3590103	56
3350216	201	3400187	117	3400311	110	3530308	46	3540142	205	3590120	56
3350220	201	3400188	117	3400312	110	3530310	46	3540143	142	3590125	56
3350501	201	3400189	117	3400313	110	3530311	46	3540143	206	3600201	201
3351005	201	3400190	117	3480101	105	3530312	46	3540144	142	3600202	201
3351006	201	3400191	117	3480102	105	3530313	46	3540144	206	3600203	201

INDICE DE CODIGOS

3600204	201	3760111	200	3771027	135	3840603	182	3860102	193	3860623	175
3600205	201	3760112	120	3771028	135	3840604	182	3860110	177	3860624	175
3600206	201	3760112	140	3771029	135	3840605	182	3860202	177	3860625	175
3600302	201	3760112	200	3771050	135	3840800	182	3860203	177	3860702	178
3600303	201	3760113	120	3771051	135	3840801	182	3860214	177	3860704	178
3600304	201	3760113	140	3771101	135	3840802	182	3860215	177	3860706	178
3600401	201	3760113	200	3771102	135	3840803	182	3860310	176	3860708	178
3600402	201	3760114	120	3771103	135	3840804	182	3860311	176	3860802	177
3600404	201	3760114	140	3771104	135	3840805	182	3860314	176	3860804	177
3600409	201	3760114	200	3820101	186	3840806	182	3860316	176	3861201	193
3600410	201	3760115	120	3820102	186	3840807	182	3860318	176	3861202	193
3600501	201	3760115	140	3820103	186	3840901	152	3860320	176	3861203	193
3600502	201	3760115	200	3820104	186	3840902	152	3860325	176	3861205	193
3600503	201	3760116	120	3820105	186	3840903	152	3860326	176	3861207	193
3600504	201	3760116	140	3820106	186	3840904	152	3860327	176	3861220	194
3600505	201	3760116	200	3820110	186	3840905	152	3860328	176	3861221	194
3600506	201	3760117	120	3820220	190	3840906	152	3860340	178	3861222	194
3600508	201	3760117	140	3830005	175	3840907	152	3860341	178	3862001	17
3600520	197	3760117	200	3830005	203	3840908	152	3860350	178	3862002	17
3600521	197	3760118	120	3830006	175	3840910	150	3860351	178	3862201	192
3600522	197	3760118	140	3830006	203	3840911	150	3860352	178	3862202	192
3600523	197	3760118	200	3830007	175	3850101	190	3860355	178	3862203	192
3600601	201	3760119	120	3830007	203	3850102	190	3860356	178	3862204	192
3600604	201	3760119	140	3830008	175	3850103	190	3860357	178	3862205	192
3600701	201	3760119	200	3830008	203	3850201	4	3860358	178	3862206	192
3700207	118	3760810	122	3830014	175	3850202	4	3860402	176	3862207	192
3700625	118	3760811	122	3830014	203	3850301	4	3860403	176	3862208	192
3701101	115	3760812	122	3830015	175	3850302	4	3860404	176	3862209	192
3701102	115	3760850	189	3830015	203	3850350	4	3860405	176	3862210	192
3701103	115	3760851	189	3830016	175	3850351	4	3860406	176	3970101	164
3701104	115	3770101	135	3830016	203	3850352	4	3860407	176	3970102	164
3701105	115	3770102	135	3830017	175	3850353	4	3860408	176	3970105	164
3701150	129	3770103	135	3830017	203	3850355	4	3860409	176	3970106	164
3701152	129	3770104	135	3830052	176	3850356	4	3860410	176	3970115	164
3701154	129	3770105	135	3830052	203	3850401	4	3860411	176	3970120	164
3701170	129	3770106	135	3830053	176	3850601	14	3860412	176	3970121	164
3701171	129	3770201	135	3830053	203	3850602	14	3860413	176	3970122	164
3701173	129	3770202	135	3830054	176	3850603	14	3860501	176	3971001	164
3701176	129	3770203	135	3830054	203	3850604	14	3860502	176	3971002	164
3701503	119	3770204	135	3830055	176	3850605	14	3860503	176	3971003	164
3701504	119	3770205	135	3830055	203	3850606	14	3860505	176	3971004	164
3710101	75	3770209	135	3830071	176	3851001	36	3860601	175	3971005	164
3710104	75	3770210	135	3830072	176	3851002	36	3860602	175	3971006	164
3710106	75	3770211	135	3830073	176	3851003	36	3860603	175	3971007	164
3710107	75	3770212	135	3840201	153	3851004	36	3860605	175	3971008	164
3710120	75	3770213	135	3840401	183	3851015	36	3860606	175	3971009	164
3710121	75	3771001	135	3840402	183	3851016	36	3860607	175	3971010	164
3710122	75	3771002	135	3840403	183	3851017	36	3860610	175	3971011	164
3760109	120	3771003	135	3840404	183	3851020	36	3860611	175	3971012	164
3760109	140	3771006	135	3840405	183	3851021	36	3860612	175	3971013	164
3760109	200	3771007	135	3840501	183	3851022	36	3860614	175	3971014	164
3760110	120	3771008	135	3840502	183	3851050	36	3860615	175	3971015	164
3760110	140	3771010	135	3840503	183	3851051	36	3860616	175	3971016	164
3760110	200	3771011	135	3840504	183	3851052	36	3860620	175	3971017	164
3760111	120	3771012	135	3840601	182	3851053	36	3860621	175	3971018	164
3760111	140	3771026	135	3840602	182	3860101	193	3860622	175	3971019	164

INDICE DE CODIGOS

4020314	216	4020509	218	4020931	217	4021521	87	4030941	213	4050307	222
4020317	216	4020510	218	4020932	217	4021522	87	4030942	213	4050308	222
4020318	216	4020511	218	4020933	217	4021534	87	4050101	221	4050309	222
4020319	216	4020512	218	4020934	217	4021535	87	4050103	221	4050401	222
4020320	216	4020517	218	4020935	217	4021536	87	4050105	221	4050402	222
4020321	216	4020609	221	4020936	217	4021550	203	4050107	221	4050403	222
4020322	216	4020612	221	4020937	217	4021551	203	4050109	221	4050404	222
4020325	216	4020617	221	4020938	217	4021552	203	4050110	221	4050405	222
4020326	216	4020623	221	4020939	217	4021553	203	4050111	221	4050406	222
4020329	216	4020628	221	4020940	217	4021554	203	4050112	221	4050407	222
4020330	216	4020634	221	4020941	217	4021555	203	4050114	221	4050408	222
4020334	216	4020639	221	4020942	217	4021556	203	4050115	221	4050501	221
4020335	216	4020705	221	4020943	217	4021557	203	4050116	221	4050502	221
4020337	216	4020706	221	4020944	217	4021701	217	4050117	221	4050503	221
4020338	216	4020707	221	4020950	217	4021702	217	4050120	221	4050505	221
4020401	218	4020708	221	4020951	217	4021703	217	4050121	221	4050605	223
4020402	218	4020709	221	4020952	217	4021704	217	4050122	221	4110101	212
4020403	218	4020710	221	4020953	217	4021705	217	4050123	221	4110102	212
4020404	218	4020711	221	4020954	217	4021706	217	4050126	221	4110103	212
4020405	218	4020715	222	4020955	217	4030112	213	4050128	221	4110104	212
4020406	218	4020716	222	4021001	88	4030330	214	4050129	221	4110105	212
4020407	218	4020718	222	4021002	88	4030351	214	4050130	221	4110106	212
4020408	218	4020719	222	4021003	88	4030352	214	4050131	221	4110107	212
4020409	218	4020720	222	4021004	88	4030353	214	4050135	221	4110108	212
4020410	218	4020721	222	4021006	217	4030354	214	4050136	221	4110109	212
4020411	218	4020722	222	4021007	217	4030355	214	4050137	221	4110120	212
4020413	218	4020723	222	4021008	217	4030356	214	4050138	221	4110121	212
4020414	218	4020724	222	4021009	217	4030401	222	4050201	221	4110122	212
4020415	218	4020730	222	4021010	217	4030402	222	4050203	221	4110123	212
4020416	218	4020732	222	4021011	217	4030403	222	4050205	221	4110124	212
4020417	218	4020733	222	4021012	217	4030404	222	4050207	221	4110125	212
4020418	218	4020901	217	4021013	217	4030405	222	4050209	221	4110126	212
4020420	218	4020902	217	4021014	217	4030406	222	4050210	221	4110127	212
4020421	218	4020903	217	4021021	217	4030407	222	4050211	221	4110128	212
4020422	218	4020904	217	4021022	217	4030408	222	4050212	221	4110129	212
4020423	218	4020905	217	4021023	217	4030409	222	4050214	221	4110130	212
4020425	218	4020906	217	4021024	217	4030410	222	4050215	221	4110131	212
4020426	218	4020907	217	4021110	218	4030411	222	4050216	221	4110132	212
4020427	218	4020908	217	4021111	218	4030412	222	4050217	221	4110133	212
4020428	218	4020909	217	4021112	218	4030413	222	4050220	221	4110140	212
4020429	218	4020910	217	4021113	218	4030414	222	4050221	221	4110141	212
4020440	218	4020911	217	4021201	217	4030415	222	4050222	221	4110142	212
4020441	218	4020912	217	4021205	217	4030420	222	4050225	221	4110143	212
4020442	218	4020913	217	4021210	217	4030421	222	4050226	221	4110144	212
4020443	218	4020914	217	4021501	219	4030422	222	4050227	221	4110145	212
4020444	218	4020915	217	4021502	219	4030423	222	4050228	221	4110146	212
4020445	218	4020916	217	4021503	219	4030802	214	4050229	221	4110147	212
4020500	218	4020917	217	4021504	219	4030804	214	4050235	221	4110148	212
4020501	218	4020918	217	4021505	219	4030806	214	4050236	221	4110149	212
4020502	218	4020919	217	4021506	219	4030820	214	4050237	221	4110150	212
4020503	218	4020925	217	4021507	219	4030821	214	4050301	222	4110151	212
4020504	218	4020926	217	4021508	219	4030901	213	4050302	222	4110152	212
4020505	218	4020927	217	4021509	219	4030902	213	4050303	222	4110153	212
4020506	218	4020928	217	4021510	219	4030903	213	4050304	222	4110160	212
4020507	218	4020929	217	4021511	219	4030904	213	4050305	222	4110161	212
4020508	218	4020930	217	4021520	87	4030940	213	4050306	222	4110162	212

INDICE DE CODIGOS

4110163	212	4520301	25	4890214	132	4991012	177	5070210	236	5218434	235
4110164	212	4520350	25	4890215	132	4991013	177	5070211	236	5218439	235
4110165	212	4520351	25	4890216	132	4991014	177	5070212	236	5218440	235
4110166	212	4520352	25	4890217	132	4991015	177	5070213	236	5218441	235
4110167	212	4520353	25	4990102	142	4991020	177	5070214	236	5218442	235
4110168	212	4520355	25	4990103	142	4991021	177	5070215	236	5218447	235
4110169	212	4520356	25	4990104	142	4991022	177	5070216	236	5218448	235
4110170	212	4520360	20	4990106	142	4991030	177	5070217	236	5218449	235
4110171	212	4520370	23	4990107	142	4991031	177	5070218	236	5218450	235
4170101	213	4520371	23	4990111	142	4991032	177	5070219	236	5218455	235
4170102	213	4520373	23	4990112	142	5030101	236	5070220	236	5218456	235
4170103	213	4520377	23	4990113	142	5030102	236	5070221	236	5218457	235
4170104	213	4520402	27	4990114	142	5050401	238	5070222	236	5218458	235
4170105	213	4520412	27	4990115	143	5050402	238	5070223	236	5218463	235
4170106	213	4520422	27	4990121	143	5050403	238	5070224	236	5218464	235
4170107	213	4520432	27	4990122	143	5070101	236	5070225	236	5218465	235
4170201	213	4670101	118	4990123	143	5070102	236	5070226	236	5218466	235
4170202	213	4670102	118	4990125	143	5070103	236	5070227	236	5220101	133
4170203	213	4670103	118	4990126	143	5070104	236	5070228	236	5220103	133
4170204	213	4670104	118	4990127	143	5070105	236	5070229	236	5220104	133
4170205	213	4670150	122	4990131	143	5070106	236	5070230	236	5220161	134
4170206	213	4670152	12	4990132	143	5070107	236	5070231	236	5220164	134
4170207	213	4670202	122	4990133	143	5070108	236	5070232	236	5220165	134
4171101	213	4670203	122	4990134	143	5070109	236	5218342	235	5220193	134
4171102	213	4670208	122	4990135	143	5070110	236	5218345	235	5220200	121
4171103	213	4890101	131	4990250	143	5070111	236	5218348	235	5220201	121
4171104	213	4890102	131	4990251	143	5070112	236	5218349	235	5220210	122
4171105	213	4890103	131	4990252	143	5070113	236	5218353	235	5220215	122
4171106	213			4990253	143	5070114	236	5218354	235	5220216	122
4171501	213	4890104	131	4990301	143	5070115	236	5218355	235	5220501	112
4171502	213	4890105	131	4990302	143	5070116	236	5218356	235	5220502	112
4171503	213	4890106	131	4990305	143	5070117	236	5218361	235	5220504	112
4171505	213	4890107	131	4990307	143	5070118	236	5218362	235	5220512	112
4171506	213	4890108	131	4990309	143	5070119	236	5218363	235	5220514	112
4171507	213	4890109	131	4990320	143	5070120	236	5218364	235	5220515	112
4172001	213	4890110	131	4990321	143	5070121	236	5218369	235	5220520	112
4360005	129	4890111	131	4990322	143	5070122	236	5218370	235	5220521	112
4360006	129	4890112	131	4990323	143	5070123	236	5218371	235	5220522	112
4360009	129	4890113	131	4990324	143	5070124	236	5218372	235	5220525	115
4360010	129	4890114	132	4990501	235	5070125	236	5218373	235	5220542	110
4360013	129	4890115	132	4990503	235	5070126	236	5218378	235	5220543	110
4360020	129	4890116	132	4990505	235	5070127	236	5218407	235	5220550	107
4360022	129	4890117	132	4990790	177	5070128	236	5218408	235	5220551	107
4360026	129	4890201	131	4990791	177	5070129	236	5218409	235	5220555	108
4360030	129	4890202	131	4990792	177	5070130	236	5218410	235	5220556	108
4520100	25	4890203	131	4990793	177	5070131	236	5218415	235	5300101	236
4520101	25	4890204	131	4990801	177	5070132	236	5218416	235	5300102	236
4520210	25	4890205	131	4990802	177	5070201	236	5218417	235	5310501	237
4520211	25	4890206	131	4990803	177	5070202	236	5218418	235	5310502	237
4520220	25	4890207	131	4990804	177	5070203	236	5218423	235	5310503	237
4520221	25	4890208	131	4990811	177	5070204	236	5218424	235	5310504	237
4520223	25	4890209	131	4990812	177	5070205	236	5218425	235	5310505	237
4520224	25	4890210	131	4990813	177	5070206	236	5218426	235	5310506	237
4520225	25	4890211	131	4990814	177	5070207	236	5218431	235	5310507	237
4520226	25	4890212	131	4991010	177	5070208	236	5218432	235	5310508	237
4520300	25	4890213	131	4991011	177	5070209	236	5218433	235	5310509	237

INDICE DE CODIGOS

5310510	237	5360131	235	5800134	229	6060202	231	6060706	231	6061220	232
5310511	237	5360132	235	5800140	229	6060203	231	6060707	231	6061221	232
5310512	237	5360133	235	5800141	229	6060204	231	6060802	231	6061222	232
5310513	237	5360134	235	5800150	228	6060205	231	6060804	231	6061225	232
5310514	237	5360150	235	5800160	228	6060206	231	6060806	231	6061226	232
5310515	237	5360151	235	5800161	228	6060207	231	6060808	231	6061227	232
5310516	237	5400163	236	5880325	185	6060208	231	6060810	231	6061228	232
5310517	237	5550001	227	6010001	225	6060209	231	6060812	231	6061229	232
5310518	237	5550002	227	6010002	225	6060301	231	6060814	231	6061230	232
5310631	237	5550003	227	6010100	225	6060302	231	6060816	231	6061233	232
5310632	237	5550004	227	6010101	225	6060303	231	6060818	231	6061234	232
5310633	237	5550005	227	6010102	225	6060304	231	6060820	231	6061235	232
5310634	237	5550006	227	6010103	225	6060305	231	6060822	231	6061236	232
5310635	237	5550010	227	6010104	225	6060306	231	6060824	231	6061237	232
5310636	237	5550011	227	6010105	225	6060307	231	6060826	231	6061238	232
5310637	237	5550012	227	6010114	225	6060308	231	6060828	231	6061241	232
5310638	237	5550013	227	6010115	225	6060309	231	6060830	231	6061242	232
5310639	237	5550014	227	6010130	225	6060310	231	6060901	231	6061243	232
5310640	237	5550015	227	6010200	225	6060311	231	6060902	231	6061244	232
5310641	237	5550099	227	6010201	225	6060312	231	6060903	231	6061245	232
5310642	237	5550100	227	6010202	225	6060313	231	6060904	231	6061246	232
5310643	237	5550101	227	6010203	225	6060314	231	6060905	231	6061249	232
5310644	237	5550102	227	6010204	225	6060315	231	6060906	231	6061250	232
5310645	237	5550103	227	6010205	225	6060316	231	6061009	231	6061251	232
5310646	237	5550104	227	6010206	225	6060317	231	6061010	231	6061252	232
5310647	237	5550105	227	6010207	225	6060460	232	6061011	231	6061253	232
5310648	237	5550106	227	6010301	225	6060461	232	6061012	231	6061254	232
5330101	236	5550107	227	6010302	225	6060462	232	6061013	231	6061265	232
5330105	236	5550108	227	6010401	225	6060463	232	6061014	231	6061266	232
5330110	236	5550109	227	6010403	225	6060464	232	6061025	231	6061267	232
5330115	236	5550110	227	6010404	225	6060466	232	6061026	231	6061268	232
5330120	236	5550111	227	6010506	225	6060470	232	6061027	231	6061269	232
5330125	236	5550113	227	6010507	225	6060471	232	6061028	231	6061270	232
5330130	236	5550118	227	6010601	225	6060472	232	6061029	231	6061273	232
5330135	236	5550120	227	6010701	225	6060473	232	6061030	231	6061274	232
5330140	236	5550121	227	6010702	225	6060474	232	6061041	231	6061275	232
5330145	236	5550122	227	6010711	225	6060476	232	6061042	231	6061276	232
5330150	236	5550125	227	6010712	225	6060501	231	6061043	231	6061277	232
5330155	236	5550126	227	6010750	225	6060502	231	6061044	231	6061278	232
5330160	236	5550211	228	6010751	225	6060503	231	6061045	231	6061281	232
5330165	236	5550212	228	6010752	225	6060504	231	6061046	231	6061282	232
5330170	236	5550213	228	6010753	225	6060505	231	6061073	231	6061283	232
5360101	235	5550214	228	6010755	225	6060506	231	6061074	231	6061284	232
5360102	235	5550215	228	6060101	231	6060507	231	6061075	231	6061285	232
5360103	235	5550301	227	6060102	231	6060601	231	6061076	231	6061286	232
5360104	235	5550302	227	6060103	231	6060602	231	6061077	231	6061289	232
5360105	235	5800101	229	6060104	231	6060603	231	6061078	231	6061290	232
5360106	235	5800102	229	6060105	231	6060604	231	6061201	232	6061291	232
5360107	235	5800104	228	6060106	231	6060605	231	6061202	232	6061292	232
5360108	235	5800105	228	6060107	231	6060606	231	6061203	232	6061293	232
5360120	235	5800106	228	6060108	231	6060607	231	6061204	232	6061294	232
5360121	235	5800109	229	6060109	231	6060701	231	6061205	232	6061401	232
5360122	235	5800110	229	6060110	231	6060702	231	6061206	232	6061402	232
5360123	235	5800112	229	6060111	231	6060703	231	6061217	232	6061403	232
5360124	235	5800115	229	6060112	231	6060704	231	6061218	232	6061404	232
5360130	235	5800120	229	6060201	231	6060705	231	6061219	232	6061405	232

INDICE DE CODIGOS

6061406	232	6064021	238	8050205	165	9041950	190	9043102	46	9045038	237
6061417	232	6064022	238	8050206	165	9041951	190	9043201	195	9045039	237
6061418	232	6064023	238	8050207	165	9041952	190	9043202	195	9045040	237
6061419	232	6064024	238	8050208	165	9041953	190	9043203	195	9045041	237
6061420	232	6080101	233	8050209	165	9041954	190	9043204	195	9045042	237
6061421	232	6080102	233	8050210	165	9041955	190	9043205	195	9045043	237
6061422	232	6080103	233	8050211	165	9041956	190	9043206	195	9045045	237
6061425	232	6080104	233	8050212	165	9041957	190	9043207	195	9045120	237
6061426	232	6080105	233	8050213	165	9041958	190	9043208	195	9045122	237
6061427	232	6080110	233	8050214	165	9041959	190	9043209	195	9045124	237
6061428	232	6080111	233	8050215	166	9041970	191	9043210	195	9045128	237
6061429	232	6080112	233	8050216	166	9041971	191	9043211	195	9045130	237
6061430	232	6080113	233	8050217	166	9041972	191	9043212	195	9046015	237
6061433	232	6080116	233	8050218	166	9041980	28	9043213	195	9046016	237
6061434	232	6080117	233	8050219	166	9041981	28	9043214	195	9047001	237
6061435	232	6080118	233	8050220	166	9041982	28	9043301	53	9047002	237
6061436	232	6080119	233	8050221	166	9041983	28	9043310	203	9047003	237
6061437	232	6080120	233	8200101	131	9041984	28	9043315	92	9047004	237
6061438	232	6080150	233	8200102	131	9041985	28	9043316	92	9047005	237
6061441	232	6080151	233	8200103	131	9041986	28	9043317	92	9047006	237
6061442	232	6080152	233	8500101	199	9042007	171	9043318	92	9047007	237
6061443	232	6080153	233	8500102	199	9042008	171	9043320	192	9047401	212
6061444	232	6080154	233	9041050	126	9043001	48	9043321	192	9047402	212
6061445	232	6080155	233	9041051	126	9043005	101	9043325	92	9047403	212
6061446	232	6080156	233	9041052	126	9043006	101	9043326	92	9047404	212
6061449	232	6080157	233	9041053	126	9043015	85	9043327	92	9047405	212
6061450	232	6080202	233	9041054	126	9043016	85	9043328	92	9047406	212
6061451	232	6080203	233	9041055	126	9043017	102	9043330	27	9047407	212
6061452	232	6080204	233	9041056	126	9043018	102	9043331	27	9047408	212
6061453	232	6080205	233	9041060	125	9043020	45	9043332	27	9047505	212
6061454	232	6080206	233	9041061	125	9043021	45	9043333	27	9047506	212
6061465	232	6080207	233	9041062	125	9043022	45	9043334	27	9047507	212
6061466	232	8050101	165	9041063	125	9043030	34	9043335	27	9047508	212
6061467	232	8050102	165	9041064	125	9043031	34	9043350	27	9047511	212
6061468	232	8050103	165	9041201	152	9043032	34	9043351	27	9047512	212
6061469	232	8050104	165	9041202	152	9043040	191	9043352	27	9047513	212
6061470	232	8050105	165	9041203	152	9043041	191	9043353	27	9047514	212
6061473	232	8050106	165	9041204	152	9043075	189	9043360	27	9047515	212
6061474	232	8050107	165	9041205	152	9043076	189	9043361	27	9047516	212
6061475	232	8050108	165	9041301	33	9043080	198	9043362	27	9047520	212
6061476	232	8050109	165	9041302	33	9043081	198	9043363	27	9047521	212
6061477	232	8050110	165	9041901	9	9043082	198	9043499	44	9047522	212
6061478	232	8050111	165	9041902	9	9043083	198	9043500	44	9047523	212
6061481	232	8050112	165	9041903	9	9043084	198	9043501	119	9047524	212
6061482	232	8050113	165	9041904	9	9043085	198	9043506	119	9047525	212
6061483	232	8050114	165	9041910	9	9043090	40	9043801	119	9047526	212
6061484	232	8050115	165	9041911	9	9043091	40	9043802	119	9047527	212
6061485	232	8050116	165	9041912	9	9043092	9	9045029	237	9047530	212
6061486	232	8050117	165	9041913	9	9043093	9	9045030	237	9047531	212
6061489	232	8050118	165	9041920	9	9043094	9	9045031	237	9047532	212
6061490	232	8050119	165	9041921	9	9043095	9	9045032	237	9047533	212
6061491	232	8050120	165	9041925	9	9043096	9	9045033	237	9047534	212
6061492	232	8050201	165	9041926	9	9043097	9	9045034	237	9047542	212
6061493	232	8050202	165	9041927	9	9043098	9	9045035	237	9047543	212
6061494	232	8050203	165	9041935	9	9043099	9	9045036	237	9047544	212
6064020	238	8050204	165	9041936	9	9043101	46	9045037	237	9047545	212

INDICE DE CODIGOS

9047546	212	9070190	171	9121042	50	9123706	125	9130106	115	20001601	98
9047547	212	9080101	76	9121045	49	9123707	125	9130107	115	20001602	98
9047548	212	9080102	76	9121046	49	9123901	127	9130110	108	20001603	98
9047801	238	9080103	76	9121047	49	9123902	127	9130111	107	20001611	98
9047802	238	9080104	76	9121049	49	9123903	127	9130120	114	20001612	98
9047803	238	9080105	76	9121050	103	9123904	127	9130121	114	20001613	98
9047804	238	9080106	76	9121051	103	9123905	127	9130122	114	20001701	98
9047805	238	9080110	76	9121052	103	9123906	127	9130125	113	20001702	98
9047806	238	9080111	76	9121053	103	9123920	127	9130130	113	20001703	98
9047809	238	9080112	76	9121054	103	9123921	127	9130131	113	20001711	98
9047810	238	9080113	76	9121056	103	9123925	127	9130135	113	20001712	98
9047811	238	9080114	76	9121059	104	9123928	127	9130136	113	20001713	98
9047812	238	9080120	76	9121060	104	9123929	127	9130145	113	20001801	98
9047813	238	9080121	76	9121061	104	9123940	127	9130160	113	20001802	98
9047814	238	9080130	76	9121070	101	9123941	127	9130161	113	20001803	98
9047901	238	9080131	76	9122001	49	9123946	127	9130170	113	20210040	94
9047902	238	9090110	55	9122002	49	9123950	126	9130171	113	20211010	160
9047910	238	9090112	55	9122003	49	9123951	126	9130172	113	20211020	160
9047911	238	9100101	55	9122008	49	9123952	126	9130173	113	20211040	160
9047912	238	9100102	55	9122015	49	9123953	126	9130174	113	20211050	160
9047915	238	9110101	73	9122016	49	9123954	126	9130175	113	20211060	160
9047916	238	9110102	73	9122017	49	9123955	126	9130180	113	20211080	160
9047917	238	9110105	73	9122020	49	9124001	139	9130190	113	20211090	160
9047940	238	9110106	73	9122021	49	9124002	139	9140101	76	20211100	160
9047941	238	9110110	73	9122022	49	9124010	139	9140102	76	20211120	160
9047942	238	9110111	73	9122501	125	9124011	139	9140103	76	20215010	87
9047960	238	9110112	73	9122502	125	9124012	139	9140104	76	20215020	87
9050101	61	9110113	73	9122503	125	9124020	139	9140105	76	20215030	87
9050102	61	9110114	73	9122504	125	9125001	120	9140106	76	20215040	87
9051001	61	9110115	73	9122505	125	9125001	200	9140120	76	20215050	87
9051002	61	9110120	73	9122506	125	9125002	120	9140121	76	20215060	87
9051005	61	9110121	73	9122507	125	9125002	200	9140130	76	20215070	87
9051006	61	9110125	73	9122508	125	9125003	120	9140131	76	20215100	87
9051010	61	9110130	73	9122510	125	9125003	200	9140132	76	20215110	87
9051011	61	9110131	73	9122511	125	9125004	120	9140150	77	20215120	87
9051015	61	9121001	49	9122512	125	9125004	200	9140151	77	20215130	87
9051016	61	9121002	49	9122513	125	9125010	139	10501020	53	20215140	87
9051020	61	9121003	49	9122514	125	9125020	136	10905180	75	20215150	87
9051021	61	9121005	49	9122515	125	9125021	136	10905181	75	20215170	87
9051022	61	9121010	49	9122516	125	9125022	136	11202120	55	20905230	95
9051101	61	9121015	49	9122517	125	9125023	136	11202130	55	20905231	95
9051105	61	9121018	49	9123501	125	9125024	136	11202140	55	20905232	95
9051107	61	9121020	49	9123502	125	9125025	137	11202141	55	20907070	95
9051110	61	9121022	49	9123503	125	9125028	137	11740170	185	20907080	95
9051113	61	9121025	49	9123504	125	9125040	199	11740180	185	20907190	95
9051115	61	9121026	49	9123505	125	9125042	199	11902050	39	20907200	95
9070101	171	9121027	49	9123506	125	9125201	162	11902070	39	20907230	95
9070102	171	9121030	49	9123507	125	9125202	162	11902080	39	20908230	96
9070103	171	9121031	49	9123508	125	9125210	162	13901220	188	20908231	96
9070110	53	9121032	49	9123509	125	9125211	162	13901230	188	20908232	96
9070111	53	9121033	49	9123510	125	9125212	162	13901240	188	20910070	96
9070112	53	9121035	49	9123701	125	9125213	162	13901250	188	20910080	96
9070120	171	9121036	49	9123702	125	9129010	118	13901520	188	20910190	96
9070121	171	9121038	49	9123703	125	9130101	113	13901530	188	20910201	96
9070130	171	9121039	49	9123704	125	9130102	113	13901540	188	20910230	96
9070131	171	9121040	49	9123705	125	9130105	115	13901550	188	22001060	101

INDICE DE CODIGOS

22001090	101	22503300	3	22507023	203	23531557	139	23808021	148	24010010	85
22001120	101	22503320	3	22507210	17	23532997	102	23808022	148	24010020	85
22001180	101	22503520	17	22507211	17	23532998	89	23808030	148	24010040	85
22005100	103	22503540	17	22507212	17	23533216	140	23808031	148	24101190	37
22005101	103	22503560	17	22507300	18	23533217	140	23808032	148	24101220	37
22007080	140	22503600	18	22507320	18	23533220	140	23809010	149	24101250	37
22007190	119	22503610	18	22508010	98	23533221	140	23809020	149	24101280	37
22007200	119	22503700	18	22508030	98	23533222	140	23818010	148	24101310	37
22007450	120	22503720	18	22510010	28	23533232	140	23818011	148	24101340	37
22007450	200	22503740	17	22510020	28	23533233	140	23818012	148	24101370	37
22007451	120	22503800	18	22510030	28	23533234	140	23831170	157	24102170	33
22007451	200	22503820	18	22510031	28	23533235	140	23833050	157	24102180	33
22007460	120	22503840	18	22510032	28	23533272	140	23833110	157	24102270	33
22007460	200	22503860	18	22510100	28	23533381	140	23833111	157	24102280	33
22007461	120	22503920	17	22510110	28	23533382	139	23834050	159	24102350	33
22007461	200	22503921	17	22510120	28	23533383	139	23834110	159	24102360	33
22007470	146	22503922	17	22510121	28	23533384	139	23834120	159	24103090	35
22007471	146	22503940	17	22510122	28	23533455	44	23834160	159	24103091	35
22007472	146	22503941	17	22510150	28	23533671	126	23834180	159	24103092	35
22007480	146	22503942	17	22510160	28	23533672	126	23834210	159	24103210	35
22007481	146	22503960	17	22510170	28	23533673	126	23834270	159	24103211	35
22007482	146	22504410	3	22510171	28	23533674	126	23840460	130	24103212	35
22007490	146	22504420	3	22510172	28	23533741	121	23840470	130	24103360	35
22007491	146	22505300	13	22510200	28	23534121	121	23840470	161	24103361	35
22007492	146	22505500	13	22510210	28	23534122	121	23840471	130	24103362	35
22007500	146	22505600	14	22510220	28	23534123	121	23840471	161	24103500	35
22007501	146	22505610	14	22510221	28	23534124	121	23840472	130	24103510	35
22007502	146	22505620	14	22510222	28	23534126	108	23840472	161	24103530	35
22007510	146	22505700	14	22510250	28	23534390	121	23840490	130	24103610	35
22007511	146	22505710	14	22510260	28	23534391	137	23840490	161	24103611	35
22007512	146	22505740	14	22510270	28	23534392	137	23840491	130	24103612	35
22010010	29	22505750	14	22510271	28	23534393	137	23840491	161	24103660	35
22010110	29	22505760	14	22510272	28	23534395	137	23840492	130	24103661	35
22203030	197	22505770	14	22910010	87	23534396	137	23840492	161	24103662	35
22203040	197	22506100	13	22910020	87	23599995	121	23840500	130	24317060	84
22203050	197	22506290	13	22910030	87	23604010	145	23840500	161	24317070	84
22203060	195	22506500	13	22910040	87	23604011	145	23840520	130	24325100	86
22203070	195	22506550	14	22910080	87	23604012	145	23840520	161	24325110	86
22203080	195	22506560	14	22910090	87	23604013	145	23840521	130	24327010	92
22203090	195	22506570	14	22910100	87	23604014	145	23840521	161	24327020	92
22203100	198	22506700	14	22910110	87	23604015	145	23840522	130	24327030	92
22203110	198	22506710	14	22910120	87	23604016	145	23840522	161	24330100	19
22350201	197	22506720	14	22910130	87	23604017	145	23899300	130	24330110	19
22350202	197	22506800	14	22910140	87	23604018	145	23899301	161	24333150	19
22350203	197	22506810	14	22910150	87	23605010	47	23899311	161	24333160	19
22350210	197	22506840	13	23030010	36	23605011	47	23899311	130	24336010	85
22350211	197	22506850	13	23030011	36	23605020	48	23899321	161	24336020	85
22350212	197	22506880	13	23030012	36	23605021	48	23899331	161	24336030	85
22503010	3	22506900	13	23030020	36	23605030	48	23899331	130	24338010	89
22503030	3	22506920	13	23030021	36	23605031	48	23899341	130	24338020	89
22503050	3	22506930	13	23030022	36	23715010	35	23899341	161	24338030	89
22503070	3	22507010	203	23030030	36	23715100	35	23899351	161	24338040	89
22503200	3	22507011	203	23030031	36	23808010	148	23899351	130	24340030	176
22503220	3	22507012	203	23030032	36	23808011	148	24005090	84	24340040	203
22503240	3	22507020	203	23531511	137	23808012	148	24005091	84	24340040	176
22503260	3	22507022	203	23531556	139	23808020	148	24005092	84	24341010	191

INDICE DE CODIGOS

24341020	191	25008100	6	26300105	190	30902601	24	35303540	46	38503560	4
24341120	189	25008401	6	26300106	190	30902610	24	35303550	46	38504010	4
24345010	84	25008600	1	26300107	190	30902611	24	35303560	46	38510010	36
24345030	84	25009111	7	26300108	190	30902620	24	35303570	46	38510011	36
24915010	83	25009162	7	26300109	190	30902621	24	37011540	129	38510012	36
24915020	83	25009168	7	26300110	190	30902630	24	37011541	129	38510020	36
24916010	83	25009401	4	26300130	191	30902631	24	37011542	129	38510021	36
24916020	83	25010052	1	26300131	191	30902640	24	38202201	190	38510022	36
24916030	83	25010600	15	26300132	191	30902641	24	38202202	190	38510030	36
24916040	83	25010681	15	26300134	191	30902650	24	38202203	190	38510031	36
24916050	83	25010711	15	26300135	191	30902651	24	38202204	190	38510040	36
24920320	3	25011040	4	26300150	191	30902660	24	38202205	190	38510041	36
24925010	189	25011140	4	26300270	190	30902661	24	38202206	190	38510042	36
24999150	1	25012120	4	26300271	190	30902670	24	38202207	190	38510150	36
24999151	1	25012150	4	26300272	190	30902671	24	38202208	190	38510151	36
24999152	1	25016612	15	26300273	190	30902680	24	38202209	190	38510152	36
25001010	3	25018583	14	26300274	190	30902681	24	38300050	175	38510160	36
25001020	3	25018822	14	26300275	190	31010030	26	38300050	203	38510161	36
25001030	18	25019160	1	26300276	190	31120010	136	38300060	175	38510162	36
25001030	18	25022880	7	26300277	190	31150010	136	38300060	203	38510170	36
25001032	18	25022884	7	26300278	190	31150012	136	38300070	175	38510171	36
25001040	17	25024020	4	26300500	189	31150020	136	38300070	203	38510172	36
25001500	3	25028020	7	26300510	189	31150022	136	38300080	175	38510200	36
25001510	3	25028030	7	26300520	189	31704210	22	38300080	203	38510201	36
25001570	5	25028033	7	26901140	10	31704211	22	38300140	175	38510202	36
25001572	5	25028093	7	30101010	27	31704500	22	38300140	203	38510210	36
25001574	10	25028100	7	30101011	27	31704501	22	38300150	175	38510211	36
25001577	10	25028113	15	30101012	27	31704510	22	38300150	203	38510212	36
25001593	5	25028580	8	30101020	27	31704511	22	38300160	175	38510220	36
25001594	5	25028581	8	30101021	27	31704520	22	38300160	203	38510221	36
25001790	2	25028582	8	30101022	27	31704521	22	38300170	175	38510222	36
25001830	2	25028590	8	30101030	27	32015100	152	38300170	203	38510500	36
25002320	2	25028591	8	30101031	27	32015110	152	38300520	176	38510501	36
25002330	2	25028592	8	30101032	27	32601010	84	38300520	203	38510502	36
25003220	203	25035101	7	30124000	18	34001700	117	38300530	176	38510510	36
25004010	163	25054130	7	30124010	18	34001701	117	38300530	203	38510511	36
25004020	163	25054150	7	30124020	18	34001710	117	38300540	176	38510512	36
25004030	163	25901010	185	30124030	18	34001711	117	38300540	203	38510520	36
25004040	163	25901020	185	30124040	18	34001740	117	38300550	176	38510521	36
25004050	163	25901070	185	30124050	18	34001741	117	38300550	203	38510522	36
25004060	163	25901080	185	30124060	18	34001750	117	38300710	176	38510530	36
25004070	163	25901190	185	30124070	18	34001751	117	38300720	176	38510531	36
25004080	163	25901200	185	30701010	177	34001760	117	38300730	176	38510532	36
25004100	163	25901220	185	30701020	177	34001800	117	38501030	190	38603250	176
25004110	163	25901230	185	30701030	119	34001820	117	38501031	190	38603260	176
25004120	163	25901330	185	30701030	177	34001920	118	38501032	190	38603270	176
25004130	163	25901340	185	30701040	119	34001950	118	38501033	190	38603280	176
25004140	163	25901440	185	30701040	177	34001960	118	38501034	190	38606010	175
25004150	163	26002250	168	30705010	119	34002170	111	38501040	190	38606020	175
25005030	5	26002260	168	30705030	119	35301211	44	38501041	190	38606030	175
25006050	5	26002270	168	30901020	23	35301300	45	38501042	190	38606050	175
25007010	5	26300100	190	30901080	23	35303083	46	38501043	190	38606060	175
25007540	7	26300101	190	30901510	23	35303500	46	38501044	190	38606070	175
25007541	7	26300102	190	30902030	23	35303510	46	38503010	4	38606100	175
25007600	6	26300103	190	30902090	23	35303520	46	38503020	4	38606110	175
25007901	5	26300104	190	30902600	24	35303530	46	38503550	4	38606120	175

INDICE DE CODIGOS

38606140	175	385010101	190
38606150	175	385010102	190
38606160	175	385010103	190
38606200	175	385010104	190
38606210	175	385010105	190
38606220	175	385010106	190
38606230	175	385010107	190
38606240	175	385010108	190
38606250	175	385010110	190
38607080	178	385010111	190
43600120	20	385010112	190
45204020	27	385010113	190
45204120	27	385010114	190
45204220	27	385010115	190
45204320	27	385010116	190
52202010	121	385010117	190
52202011	121	385010118	190
52202012	121	385010201	190
52202013	121	385010202	190
52202014	121	385010203	190
55501131	227	385010204	190
55501160	227	385010205	190
55501161	227	385010206	190
58001500	228	385010207	190
58001501	228	385010208	190
58001502	228	385010210	190
58001503	228	385010211	190
58001504	228	385010212	190
58001505	228	385010213	190
58001506	228	385010214	190
58001507	228	385010215	190
58001508	228	385010216	190
58001509	228	385010217	190
58001610	228	385010218	190
58001611	228	385100312	36
58001612	228	580015010	228
58001613	228	2353413196	110
58001614	228	2353413197	110
58001615	228	2353413199	110
58001616	228	2353416198	110
60802031	233	23534131990	110
91210481	50	23534131991	110
91210482	50	2353412A	121
91210483	50	2353412B	121
91210486	50	2353412C	121
91210600	104	250015790	10
235329940	101	250015794	10
235333820	139	250081020	6
263002711	190		
263002712	190		
263002713	190		
263002714	190		
263002715	190		
263002716	190		
263002717	190		
263002718	190		

LINEA "LAMA" PLASTICA

codigo	Descripcion	xcaja	U.M.
3060310	MANIJA D/BAL C/BOCALL.BLANCA	12	C/U
3060311	MANIJA D/BAL C/BOCALL.NEGRA	12	C/U
3060312	MANIJA D/BAL C/BOCALL.GRIS	12	C/U
3060320	MANIJA GIRATORIA C/BOC.BLANCA	12	C/U
3060321	MANIJA GIRATORIA C/BOC.NEGRA	12	C/U
3060322	MANIJA GIRATORIA C/BOC.GRIS	12	C/U
3060302	MANIJON AJ UNIVERSAL BLANCO	6	C/U
3060301	MANIJON AJ UNIVERSAL NEGRO	6	C/U
3060303	MANIJON AJ UNIVERSAL GRIS	6	C/U
3060330	BOCALLAVE COMUN BLANCO	24	C/U
3060331	BOCALLAVE COMUN NEGRO	24	C/U
3060332	BOCALLAVE COMUN GRIS	24	C/U
3060335	BOCALLAVE UNIVERSAL BLANCO	24	C/U
3060336	BOCALLAVE UNIVERSAL NEGRO	24	C/U
3060337	BOCALLAVE UNIVERSAL GRIS	24	C/U



OBS: D/Bal es con bocallave comun y giratoria con bocallave universal.Caso contrario indicarlo.

LINEA MINISTERIO ALUMINIO

codigo	Descripcion	xcaja	U.M.
24999150	DOBLE BAL. LIVIANA P/CORTO	12	C/U
24999151	DOBLE BAL. LIVIANA P/MEDIANO	12	C/U
24999152	DOBLE BAL. LIVIANA P/LARGO	12	C/U



LINEA MINISTERIO BRONCE

codigo	Descripcion	xcaja	U.M.
BRONCE PULIDO			
2499910	DOBLE BAL. ROS. CHAPA P/CORTO	12	C/U
2499911	DOBLE BAL. ROS. CHAPA P/MED.	12	C/U
2499912	DOBLE BAL. ROS. CHAPA P/LARGO	12	C/U
2250160	DOBLE BAL. Y CRUZ R/CHAPA P/L	12	C/U
2250122	DOBLE BAL REFORZADA P/LARGO	12	C/U
2250140	GIRATORIA LIVIANA ROS.BRONCE	12	C/U
2250144	GIRATORIA REFOR. ROS.BRONCE	12	C/U
2250162	GIRATORIA CRUZ ROS.BRONCE	12	C/U



liviana

BRONCE PLATIL

2499907	DOBLE BAL. ROS. CHAPA P/CORTO	12	C/U
2499908	DOBLE BAL. ROS. CHAPA P/MED.	12	C/U
2499909	DOBLE BAL. ROS. CHAPA P/LARGO	12	C/U
2250161	DOBLE BAL. Y CRUZ R/CHAPA P/L	12	C/U
2250123	DOBLE BAL REFORZADA P/LARGO	12	C/U
2250141	GIRATORIA LIVIANA ROS.BRONCE	12	C/U
2250145	GIRATORIA REFOR. ROS.BRONCE	12	C/U
2250170	GIRATORIA CRUZ ROS.BRONCE	12	C/U



pesada



Puño cruz

OBS: P/L : Perno largo
Bocallaves en la pag.17

LINEA BISELADA ALUMINIO

codigo	Descripcion	xcaja	U.M.
2960505	DOBLE BAL NATURAL P/LARGO	12	C/U
25001790	DOBLE BAL EPOXI P/LARGO	12	C/U
2500181	GIRATORIA - EPOXI	12	C/U
25001830	BOCALLAVE EPOXI AJ UNIVERSAL	50	C/U
2500183	BOCALLAVE EPOXI AJ COMUN	50	C/U

OBS.: Epoxi: blanco-negro-gris-marron-beige.



LINEA BISELADA BRONCE

codigo	Descripcion	xcaja	U.M.
MANIJAS LIVIANAS			
2499922	DOBLE BAL Nro 0 PULIDO	12	C/U
24999220	DOBLE BAL Nro 0 PLATIL	12	C/U
2250203	DOBLE BAL Nro.1 PULIDO	12	C/U
2250204	DOBLE BAL Nro 1 PLATIL	12	C/U
2250240	GIRATORIA Nro.1 PULIDO	12	C/U
2250241	GIRATORIA Nro 1 PLATIL	12	C/U
2250262	GIRATORIA CRUZ Nro.1 PULIDO	12	C/U
2250263	GIRATORIA CRUZ Nro.1 PLATIL	12	C/U

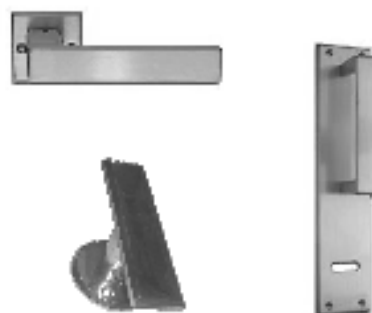

MANIJONES LIVIANOS			
2250433	MANIJON C/PLAQ 45 x 220 PULIDO	12	C/U
2250434	MANIJON C/PLAQ 45 x 220 PLATIL	12	C/U
2500233	MANIJON C/PLAQ CORTA PULIDO	12	C/U
25002330	MANIJON C/PLAQ CORTA PLATIL	12	C/U



con plaqueta corta

MANIJAS REFORZADAS			
2250211	DOBLE BALANCÍN Nro.2	12	C/U
2250212	DOBLE BALANCÍN Nro.2	12	C/U
2250250	DOBLE BALANCÍN Y CRUZ Nro.2	12	C/U
2250260	DOBLE BALANCÍN Y CRUZ Nro.2	12	C/U
2250246	GIRATORIA Nro.2	12	C/U
2250247	GIRATORIA Nro.2	12	C/U



MANIJONES REFORZADOS			
2250435	RECTO C/PLAQUETA 45x250 PULIDO	6	C/U
2250436	RECTO C/PLAQUETA 45x250 PLATIL	6	C/U
2500232	RECTO C/ROSETAS PULIDO	6	C/U
25002320	RECTO C/ROSETAS PLATIL	6	C/U
2250439	BISEL CURVO C/PLAQ. 45 x 250 PUL	6	C/U
2250440	BISEL CURVO C/PLAQ. 45 x 250 PLA	6	C/U
2250428	BISEL CURVO C/ROSETAS PUL	6	C/U
2250429	BISEL CURVO C/ROSETAS PLAT	6	C/U



Recto



Curvo

Con rosetas

OBS: Los manijones con plaqueta son ajuste universal.

Consultar por otros ajustes.(ciego,euro,cilindro 29)

Bocallaves en la pag.17

LINEA SANATORIO ALUMINIO

codigo	Descripcion	xcaja	U.M.
2290200	D/BAL ALUMINIO SATINADO	12	C/U
2290201	GIRAT ALUMINIO SATINADO	12	C/U
2290202	MANIJON ALUMINIO SATINADO	6	C/U
2290203	BOCALLAVE MIXTO	24	C/U



LINEA SANATORIO BRONCE

codigo	Descripcion	xcaja	U.M.
LINEA LIVIANA			
2250301	D/BALANCIN LIV ROS 48 PULIDO	12	C/U
22503010	D/BALANCIN LIV ROS 48 PLATIL	12	C/U
2250305	GIRATORIA LIV ROS 48 PULIDO	12	C/U
22503050	GIRATORIA LIV ROS 48 PLATIL	12	C/U
LINEA REFORZADA			
2250303	D/BALANCIN REF ROS 48 PULIDO	12	C/U
22503030	D/BALANCIN REF ROS 48 PLATIL	12	C/U
2250307	GIRATORIA REF ROS 48 PULIDO	12	C/U
22503070	GIRATORIA REF ROS 48 PLATIL	12	C/U
MANIJONES			
2250441	C/PLAQ.1/4 PTO. PULIDO	6	C/U
22504410	C/PLAQ.1/4 PTO. PLATIL	6	C/U
2250442	C/ROSETAS PULIDO	6	C/U
22504420	C/ROSETAS PLATIL	6	C/U
2492032	C/PLAQ ½ PTO PULIDO	6	C/U
24920320	C/PLAQ ½ PTO PLATIL	6	C/U

OBS: Bocallaves en la pag.17



LINEA FRANCESA

codigo	Descripcion	xcaja	U.M.
2250330	FRANCESA DOBLE BAL Nro.1 PUL	12	C/U
22503300	FRANCESA DOBLE BAL Nro.1 PLAT	12	C/U
2250332	FRANCESA GIRATORIA Nro.1 PUL	12	C/U
22503320	FRANCESA GIRATORIA Nro.1 PLAT	12	C/U

OBS: Bocallaves con filete en la pag.18



LINEA DELTA

codigo	Descripcion	xcaja	U.M.
2500101	DELTA DOBLE BAL PULIDO	12	C/U
25001010	DELTA DOBLE BAL PLATIL	12	C/U
2500102	DELTA GIRATORIA PULIDO	12	C/U
25001020	DELTA GIRATORIA PLATIL	12	C/U

OBS: Bocallaves delta en la pag.18



LINEA VIENA

codigo	Descripcion	xcaja	U.M.
2500150	VIENA DOBLE BALANCIN PULIDO	12	C/U
25001500	VIENA DOBLE BALANCIN PLATIL	12	C/U
2500151	VIENA GIRATORIA PULIDO	12	C/U
25001510	VIENA GIRATORIA PLATIL	12	C/U



LINEA TRÉBOL

codigo	Descripcion	xcaja	U.M.
PULIDO	PLATIL		
2250320	22503200 DOBLE BAL Nro.1	12	C/U
2250322	22503220 DOBLE BAL Nro.2	12	C/U
2250324	22503240 GIRATORIA Nro. 1	12	C/U
2250326	22503260 GIRATORIA Nro. 2	12	C/U

OBS: Bocallaves con filete en la pag.18



LINEA ALFA

codigo	Descripcion	xcaja	U.M.
3850301	DOBLE BALANCIN PULIDO	12	C/U
38503010	DOBLE BALANCIN PLATIL	12	C/U
3850302	GIRATORIA PULIDO	6	C/U
38503020	GIRATORIA PLATIL	6	C/U



LINEA CILÍNDRICA

codigo	Descripcion	xcaja	U.M.
3850355	DOBLE BALANCIN PULIDO	12	C/U
38503550	DOBLE BALANCIN PLATIL	12	C/U
3850356	GIRATORIA PULIDO	12	C/U
38503560	GIRATORIA PLATIL	12	C/U
3850401	MANIJON AJUSTE UNIV.PULIDO	6	C/U
38504010	MANIJON AJUSTE UNVI.PLATIL	6	C/U



LINEA PAMPA

codigo	Descripcion	xcaja	U.M.
3850350	DOBLE BALANCIN PULIDO	12	C/U
3850351	DOBLE BALANCIN PLATIL	12	C/U
3850352	GIRATORIA PULIDO	12	C/U
3850353	GIRATORIA PLATIL	12	C/U
3850201	BOCALLAVE MIXTO PULIDO	50	C/U
3850202	BOCALLAVE MIXTO PLATIL	50	C/U

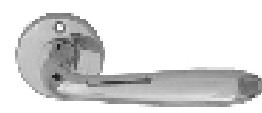

OBS: Alfa, Cilindrica y Pampa llevan el mismo bocallave



LINEAS FINAS EN BRONCE

LINEA BARI

2502402	DOBLE BALANCÍN
2502403	GIRATORIA
2502406	BOCALLAVE MIXTO
2502412	MANIJON CON PLAQUETA AJ.UNIV
2502416	MANIJON CON ROSETA

OBS: Ver listado de acabados en pag.:8

LINEA BELL ITALIA

2501101	DOBLE BALANCÍN
2501102	GIRATORIA
2501103	BOCALLAVE MIXTO
2501107	MANIJON CON PLAQUETA AJ.UNIV
25011140	MANIJON CON ROSETAS

OBS: Ver listado de acabados en pag.:8

LINEA CAPRI

25012120	DOBLE BALANCÍN
25012150	GIRATORIA
2500784	BOCALLAVE MIXTO

OBS: En pulido con laca y acerado

LINEA DIVA

2500930	DOBLE BALANCÍN
2500932	GIRATORIA
2500934	BOCALLAVE
25009401	MANIJON CON PLAQUETA AJ.UNIV

OBS: Ver listado de acabados en pag.:8





LINEA DUOMO

- 2502302 DOBLE BALANCÍN
- 2502304 GIRATORIA
- 2502306 BOCALLAVE MIXTO

OBS: Ver listado de acabados en pag.:8

LINEA ESTILO

- 2500501 DOBLE BALANCÍN
- 2500502 GIRATORIA
- 2500503 BOCALLAVE COMUN
- 25005030 BOCALLAVE UNIVERSAL
- 2500520 MANIJON CON PLAQUETA
- 2500525 MANIJON CON PLACA CORTA

OBS: En florentino y pulido laca

LINEA EUROPA

- 2501301 DOBLE BALANCÍN
- 2501302 GIRATORIA
- 2501303 BOCALLAVE MIXTO
- 2501311 MANIJON CON PLAQUETA
- 2501313 MANIJON CON ROSETA

OBS: Ver listado de acabados en pag.:8

LINEA FIORE

- 2500601 DOBLE BALANCÍN
- 2500603 GIRATORIA
- 2500605 BOCALLAVE COMUN
- 25006050 BOCALLAVE UNIVERSAL
- 2500701 MANIJON CON PLAQUETA

OBS: En florentino y pulido con laca

LINEA LATINA I (SANATORIO)

- 25001570 DOBLE BALANCÍN CON BOCALL.
- 25001572 GIRATORIA CON BOCALLAVES
- 2500784 BOCALLAVE MIXTO
- 25001593 MANIJON CON PLAQUETA
- 25001594 MANIJON CON ROSETA

OBS: En pulido con laca y acerado

LINEA LIDO

- 2500780 DOBLE BALANCÍN
- 2500782 GIRATORIA
- 2500784 BOCALLAVE MIXTO
- 2500790 MANIJON CON PLAQUETA
- 2500792 MANIJON CON ROSETA

OBS: En pulido con laca y acerado

LINEA LIMBADI

- 2501001 DOBLE BALANCÍN
- 2501102 GIRATORIA
- 2501104 BOCALLAVE

OBS: Ver listado de acabados en pag.:8

LINEA MARIANA

- 2501608 DOBLE BALANCÍN
- 2501610 GIRATORIA
- 2501612 BOCALLAVE MIXTO

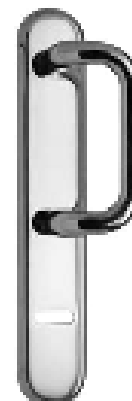
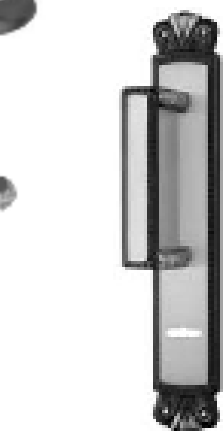
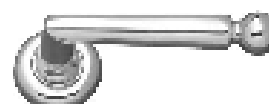



LINEA MILANO

- 2500803 DOBLE BALANCÍN
- 2500804 GIRATORIA
- 2500805 BOCALLAVE MIXTO
- 25008100 MANIJON CON PLAQ.AJ UNIV.
- 250081020 MANIJON CON ROSETA

OBS: Ver listado de acabados en pag.:8

LINEA MILENIO

- 25007600 DOBLE BALANCÍN
- 2500762 GIRATORIA
- 2500764 BOCALLAVE MIXTO

OBS: Ver listado de acabados en pag.:8

LINEA MILORD

- 2501902 DOBLE BALANCÍN
- 2501904 GIRATORIA
- 2501906 BOCALLAVE MIXTO
- 2501916 MANIJON CON PLAQUETA AJ.UNIV.
- 2501918 MANIJON CON ROSETA

OBS: Ver listado de acabados en pag.:8

LINEA NANTES

- 2500820 DOBLE BALANCÍN
- 2500826 GIRATORIA
- 2500827 BOCALLAVE MIXTO
- 25008401 MANIJON CON PLAQUETA AJ.UNIV.
- 2500855 MANIJON CON ROSETA

OBS: Ver listado de acabados en pag.:8

LINEA NOVEL

- 2500901 DOBLE BALANCÍN
- 2500902 GIRATORIA
- 2500903 BOCALLAVE MIXTO

OBS: Ver listado de acabados en pag.:8

LINEA ORIZZONTE

- 2502102 DOBLE BALANCÍN
- 2502104 GIRATORIA
- 2500452 BOCALLAVE MIXTO

OBS: Ver listado de acabados en pag.:8

LINEA PATAGONIA

- 2502201 DOBLE BALANCÍN
- 2502207 GIRATORIA
- 2502215 BOCALLAVE MIXTO

OBS: En pulido con laca y acerado

LINEA PORTOFINO

- 2502250 DOBLE BALANCÍN
- 2502253 GIRATORIA
- 2502255 BOCALLAVE MIXTO





LINEA PORTOBELLO

- 2502280 DOBLE BALANCÍN
 - 2502283 GIRATORIA
 - 2502284 BOCALLAVE MIXTO
 - 2502288 MANIJON CON PLAQUETA
 - 25022884 MANIJON CON ROSETA
- OBS: Ver listado de acabados en pag.:8



LINEA ROMA

- 2500910 DOBLE BALANCÍN
 - 2500911 GIRATORIA DERECHA
 - 25009111 GIRATORIA IZQUIERDA
 - 2500912 BOCALLAVE MIXTO
 - 25009162 MANIJON CON PLAQUETA
 - 25009168 MANIJON CON ROSETA
- OBS: En pulido con laca y acerado



izquierda

LINEA STELLA

- 2503501 DOBLE BALANCÍN
 - 2503502 GIRATORIA
 - 2503503 BOCALLAVE MIXTO
 - 25035101 MANIJON CON PLAQUETA
 - 2503511 MANIJON CON ROSETA
- OBS: En pulido con laca y acerado



LINEA SIENA

- 2500753 DOBLE BALANCÍN
 - 25007540 GIRATORIA
 - 25007541 BOCALLAVE MIXTO
- OBS: En pulido con laca y florentino



LINEA TOSCANA

- 2505401 DOBLE BALANCÍN
 - 2505402 GIRATORIA
 - 2505403 BOCALLAVE MIXTO
 - 25054130 MANIJON CON PLAQUETA
 - 25054150 MANIJON CON ROSETA
- OBS: Ver listado de acabados en pag.:8



LINEA VERONA

- 25028020 DOBLE BALANCÍN
 - 25028030 GIRATORIA DERECHA
 - 25028033 GIRATORIA IZQUIERDA
 - 25028050 BOCALLAVE MIXTO
 - 25028093 MANIJON CON PLAQUETA
 - 25028100 MANIJON CON ROSETA
- OBS: En pulido con laca y acerado

Izquierda

Todas las manijas currao vienen con sistema de retroceso lo cual garantiza la horizontalidad de la manija independientemente del estado de la cerradura.

MANIJONES LARGOS ESPECIALES EN BRONCE

Código Descripción

LINEA DUNA

- 2502824 400 MM SIMPLE
- 2502829 400 MM DOBLE
- 2502821 600 MM SIMPLE
- 2502830 600 MM DOBLE
- 2502826 800 MM SIMPLE
- 2502831 800 MM DOBLE
- 2502827 1000 MM SIMPLE
- 2502832 1000 MM DOBLE

LINEA PIAZZA

- 2502835 400 MM SIMPLE
- 2502843 400 MM DOBLE
- 2502836 600 MM SIMPLE
- 2502844 600 MM DOBLE
- 2502841 800 MM SIMPLE
- 2502845 800 MM DOBLE
- 2502838 1000 MM SIMPLE
- 2502846 1000 MM DOBLE

LINEA MILANO

- 2502850 MANIJON SIMPLE
- 2502853 MANIJON DOBLE

LINEA BELL ITALIA

- 2502858 250 MM
- 25028580 300 MM
- 25028581 400 MM
- 25028582 500 MM

LINEA EUROPA

- 2502859 250 MM
- 25028590 300 MM
- 25028591 400 MM
- 25028592 500 MM



Acabados:

- Pulido con laca*
- Acerado*
- Satinado*
- Patiné*
- Satinado con dorado*
- Satinado con cromo*
- Patiné con dorado*
- Cromo*

LINEAS CILÍNDRICAS LISAS EN ACERO INOXIDABLE



codigo **Descripcion**

MANIJAS

- 9041901 MRL 1 DOBLE BALANCÍN
- 9041910 MRL 1S GIRATORIA
- 9041902 MRL 2 DOBLE BALANCIN
- 9041911 MRL 2S GIRATORIA
- 9041903 MRL 3 DOBLE BALANCIN
- 9041912 MRL 3S GIRATORIA
- 9041904 MRU 1 DOBLE BALANCIN
- 9041913 MRU 1S GIRATORIA

OBS.: Doble balancín y giratorias incluyen bocallave.



MRL1

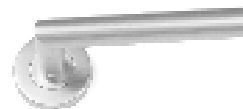

MRL2



MRL3

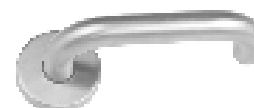

MRU1

BOCALLAVES

- 9041920 BOCALLAVE AJUSTE MIXTO
- 9041921 BOCALLAVE AJUSTE PERA



Con indicador

POMO Y BOCALLAVE BAÑO

- 9041935 CON INDICADOR LIBRE OCUPADO
- 9041936 SIN INDICADOR

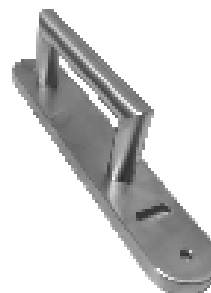

MANIJONES

- 9041925 CON PLAQUETA AJ. UNIVERSAL
- 9041926 CON ROSETAS 200 MM
- 9041927 CON ROSETAS 250 MM

MANIJONES LARGOS

- 9043092 BARRAL OVAL SIMPLE 300
- 9043093 BARRAL OVAL SIMPLE 600
- 9043097 BARRAL OVAL DOBLE 300
- 9043096 BARRAL OVAL DOBLE 600

- 9043098 BARRAL "H" DOBLE 300
- 9043099 BARRAL "H" DOBLE 500

- 9043094 FIJACION SIMPLE
- 9043095 FIJACION DOBLE

OBS.: Los manijones incluyen las fijaciones.



LINEAS EN ALUMINIO ACERADAS

codigo **Descripcion**

LINEA IMOLA

- 2505305 DOBLE BALANCÍN
- 2505308 GIRATORIA CON BOCALLAVE
- 2505311 BOCALLAVE MIXTO
- 2505320 MANIJON AJUSTE UNIVERSAL

LINEA MODENA

- 2505001 DOBLE BALANCÍN
- 2505004 GIRATORIA
- 2505006 BOCALLAVE MIXTO

LINEA SANATORIO

- 25001574 DOBLE BALANCÍN
- 25001577 GIRATORIA CON BOCALLAVE
- 250015790 BOCALLAVE MIXTO
- 250015794 MANIJON AJUSTE UNIVERSAL



MANIJONES CILINDRICOS EN ALUMINIO NATURAL

codigo **Descripcion**

	LARGO	E/CENTRO	TIPO
2021550	300	200	DOBLE
2021551	300	200	SIMPLE
2021552	300	70	DOBLE
2021553	300	70	SIMPLE
2021554	500	400	DOBLE
2021555	500	400	SIMPLE
2021556	750	600	DOBLE
2021557	750	600	SIMPLE
2021558	1000	800	DOBLE
2021559	1000	800	SIMPLE

OBS: Medidas expresadas en mm.



LINEAS EN HIERRO FORJADO

Código **Descripción** **X Caja** **U.M.**

MANIJAS

2690114	RULO DOBLE BALANCIN	1	C/U
2690123	RULO GIRATORIA	1	C/U
26901140	RETORCIDO DOBLE BALANCÍN	1	C/U
2690124	RETORCIDO GIRATORIA	1	C/U
2690115	INGLESA DOBLE BALANCÍN	1	C/U
2690125	INGLESA GIRATORIA	1	C/U
2690116	COLONIAL DOBLE BALANCÍN	1	C/U
2690126	COLONIAL GIRATORIA	1	C/U
2690117	CILÍNDRICA DOBLE BALANCÍN	1	C/U
2690127	CILÍNDRICA GIRATORIA	1	C/U

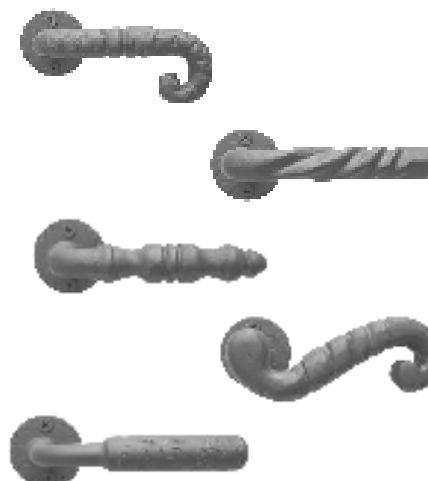

POMOS-TIRADORES

2690150	POMO CENTRAL BASE 70 MM	1	C/U
2690151	POMO OVAL FIJO	1	C/U
2690152	POMO OVAL GIRATORIO	1	C/U
2690153	POMO OVAL D/BAL	1	C/U
2690157	POMO GAJO DESPLAZADO FIJO	1	C/U
2690158	POMO GAJO DESP.GIRATORIO	1	C/U
2690159	POMO GAJO DESPLAZADO D/BAL	1	C/U
2690201	TIRADOR ARGOLLA FIJA VOLCABLE	1	C/U

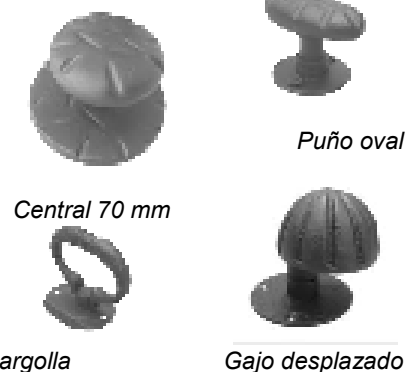

MANIJONES CON PLAQUETA

2690101	MANIJON BOLITA PLQ CHICA	1	C/U
2690104	MANIJON BOLITA PLQ GRANDE	1	C/U
2690107	MANIJON BOLITA PLQ CORRED.	1	C/U
2690102	MANIJON RETORCIDO PLQ CHICA	1	C/U
2690105	MANIJON RETORCIDO PLQ GRANDE	1	C/U
2690108	MANIJON RETORCIDO PLQ CORRED	1	C/U

OBS: Los manijones son ajuste universal
 Si desea otro ajuste, por favor indíquelo.
 Chapa grande:29 cm
 Chapa chica:24.5 cm
 Chapa porton:24.5 cm

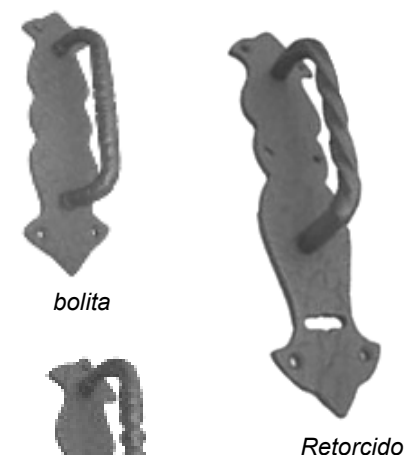

BOCALLAVES

2690142	BOCALLAVE AJUSTE COMUN	1	C/U
2690143	BOCALLAVE AJUSTE UNIVERSAL	1	C/U

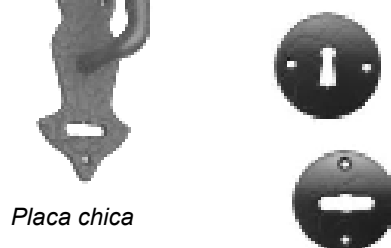

FALLEBAS

2690160	ARRIMAR 12 MM RULO	1	C/U
2690163	ARRIMAR 12 MM ARGOLLA	1	C/U
2690172	ARRIMAR 12 MM RETORCIDO	1	C/U
2690162	ARRIMAR 18 MM PUÑO RULO	1	C/U
2690165	ARRIMAR 18 MM ARGOLLA	1	C/U
2690174	ARRIMAR 18 MM RETORCIDO	1	C/U
2690161	EMBUTIR RULO	1	C/U
2690164	EMBUTIR ARGOLLA	1	C/U
2690173	EMBUTIR RETORCIDO	1	C/U

OBS: Las fallebas de arrimar incluyen los cuatro puentes y el contrafrente correspondiente.

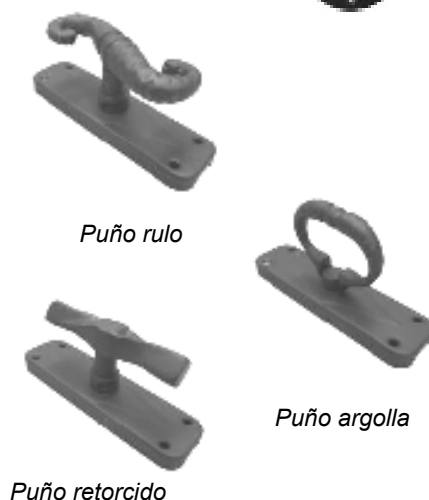

LINEA LISA

Código		Descripción	X Caja	U.M.
PULIDO	PLATIL	CENTRADO		
2250501	2250502	DOB.BAL. ROS 48	6	C/U
2250505	2250506	GIRATORIO ROS 70MM	6	C/U
2250507	2250508	FIJO ROS 70MM	6	C/U
2250684	22506840	FIJO ROS 100 MM	1	C/U
2250685	22506850	FIJO S/CHAPA 190X80	1	C/U
2250510	2250511	FIJO S/CHAPA 190X45	1	C/U



		DESPLAZADO		
2250601	2250602	DOB.BAL. ROS 48	6	C/U
2250605	2250606	GIRATORIO ROS 70MM	6	C/U
2250607	2250608	FIJO ROS 70MM	6	C/U
2250610	22506100	FIJO S/CHAPA 190X45	1	C/U



OBS: En los pomos con plaqueta, indicar ajuste.

LINEA LISA HUECA

Código		Descripción	X Caja	U.M.
PULIDO	PLATIL	CENTRADO		
3850640	38506400	DOB.BAL. ROS 48	6	C/U
3850641	38506410	GIRATORIO ROS 70MM	6	C/U
3850642	38506420	FIJO ROS 70MM	6	C/U



		DESPLAZADO		
3850650	38506500	DOB.BAL. ROS 48	6	C/U
3850651	38506510	GIRATORIO ROS 70MM	6	C/U
3850652	38506520	FIJO ROS 70MM	6	C/U

LINEA LISA CON FILETE

Código		Descripción	X Caja	U.M.
PULIDO	PLATIL	CENTRADO		
2250521	2250522	DOB.BAL. ROS 48	6	C/U
2250525	2250526	GIRATORIO ROS 70MM	6	C/U
2250527	2250528	FIJO ROS 70MM	6	C/U
2250688	22506880	FIJO ROS 100 MM	1	C/U
2250690	22506900	FIJO S/CHAPA 190X80	1	C/U
2250530	22505300	FIJO S/CHAPA 190X45	1	C/U



		DESPLAZADO		
2250621	2250622	DOB.BAL. ROS 48	6	C/U
2250625	2250626	GIRATORIO ROS 70MM	6	C/U
2250627	22506880	FIJO ROS 70MM	1	C/U
2250629	22506290	FIJO S/CHAPA 190X45	1	C/U



OBS: En los pomos con plaqueta, indicar ajuste.

LINEA FANTASIA

Código		Descripción	X Caja	U.M.
PULIDO	PLATIL	CENTRADO		
2250541	2250542	DOB.BAL. ROS 48	6	C/U
2250545	2250546	GIRATORIO R/70MM	6	C/U
2250547	2250548	FIJO R/70MM	6	C/U



2250692	22506920	FIJO ROS 100 MM	1	C/U
2250693	22506930	FIJO S/CHAPA 190X80	1	C/U
2250550	22505500	FIJO S/CHAPA 190X45	1	C/U

DESPLAZADO

2250641	2250642	DOB.BAL. ROS 48	6	C/U
2250645	2250646	GIRATORIO ROS 70MM	6	C/U
2250647	2250648	FIJO ROS 70MM	6	C/U
2250650	22506500	FIJO S/CHAPA 190X45	1	C/U

OBS: En los pomos con plaqueta, indicar ajuste.

Bocallaves en la pag.17



LINEA ESFÉRICA

Código	Descripción	X Caja	U.M.
--------	-------------	--------	------

PULIDO PLATIL

2250655	22506550	DOB.BAL. ROS 48	6	C/U
2250656	22506560	GIRATORIO ROS 70MM	6	C/U
2250657	22506570	FIJO ROS 70MM	6	C/U
2250680	22506800	FIJO ROS 100 MM	1	C/U
2250681	22506810	FIJO S/CHAPA 190X80	1	C/U

OBS: En los pomos con plaqueta, indicar ajuste.

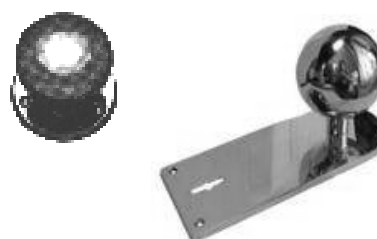

LINEA MEMORY

Código	Descripción	X Caja	U.M.
--------	-------------	--------	------

PULIDO PLATIL CENTRADO

2250560	22505600	DOB.BAL. ROS 48	6	C/U
2250561	22505610	GIRATORIO ROS 70MM	6	C/U
2250562	22505620	FIJO ROS 70MM	6	C/U

DESPLAZADO

2250670	22506700	DOB.BAL. ROS 48	6	C/U
2250671	22506710	GIRATORIO ROS 70MM	6	C/U
2250672	22506720	FIJO ROS 70MM	6	C/U



LINEA SEÑORIAL

Código	Descripción	X Caja	U.M.
--------	-------------	--------	------

PULIDO PLATIL CENTRADO

2250570	22505700	DOB.BAL. ROS 48	6	C/U
2250571	22505710	GIRATORIO ROS 70MM	6	C/U
2250572	22505720	FIJO ROS 70MM	6	C/U

DESPLAZADO

2250575	22505750	DOB.BAL. ROS 48	6	C/U
2250576	22505760	GIRATORIO ROS 70MM	6	C/U
2250577	22505770	FIJO ROS 70MM	6	C/U



LINEA OVAL

Código	Descripción	X Caja	U.M.
--------	-------------	--------	------

PULIDO PLATIL

3850601	3850604	DOB.BAL. ROS 48	12	C/U
3850602	3850605	GIRATORIO ROS 48MM	6	C/U
3850603	3850606	FIJO ROS 48MM	6	C/U

OBS: Va con bocallave "pampa" – pag.4





LINEA EUROPA

Código	Descripción	X Caja	U.M.
2501850	CENTRADO D/BAL	1	C/U
2501852	CENTRADO GIRATORIO	1	C/U
25018583	CENTRADO FIJO	1	C/U
2501860	DESPLAZADO D/BAL	1	C/U
2501872	DESPLAZADO GIRATORIO	1	C/U
25018822	DESPLAZADO FIJO	1	C/U

OBS: Ver listado de acabados en pag.:8
Va con bocallave "lido" – pag.5



LINEA LIMBADI

Código	Descripción	X Caja	U.M.
2501060	CENTRADO DOBLE BALANCÍN	1	C/U
25010681	CENTRADO GIRATORIO ROS 64	1	C/U
2501072	CENTRADO FIJO ROS 70	1	C/U
25010601	DESPLAZADO DOBLE BALANCIN	1	C/U
2501068	DESPLAZADO GIRATORIO ROS 64	1	C/U
25010711	DESPLAZADO FIJO ROS 70	1	C/U

OBS: Ver listado de acabados en pag.:8
Va con bocallave "milano" – pag.6



LINEA MARIANA

Código	Descripción	X Caja	U.M.
2501650	DOBLE BALANCÍN	1	C/U
2501652	GIRATORIO	1	C/U
25016612	FIJO	1	C/U

OBS: Ver listado de acabados en pag.:8
Va con bocallave "milano" – pag.6



LINEA VERONA

Código	Descripción	X Caja	U.M.
2502811	FIJO ROSETA 85 MM	1	C/U
25028113	SOBRE PLACA HORIZONTAL	1	C/U

OBS: Consultar por los acabados disponibles
En pomo con plaqueta, indicar el ajuste.
Ver listado de acabados en pag.:8



*Pomos forjados
en la pag.11*

HERRAJES PARA PÓSTIGO

Código	Descripción	X Caja	U.M.
PULIDO PLATIL	ARGOLLA LISA		
2092101	2092102 CON BASE FIJA	12	C/U
2092105	2092106 CON PERNO P/MANIJA	12	C/U
	ARGOLLA DE ESTILO		
2092107	2092108 CON PERNO P/MANIJA	12	C/U



MANIJAS PARA PUERTA PLEGADIZA

Código	Descripción	X Caja	U.M.
2431001	MANIJA FIJA BCE. PULIDO	12	C/U
2431002	MANIJA FIJA ACERO	12	C/U
2431003	MANIJA MOVIL BCE. PULIDO	12	C/U
2431004	MANIJA MOVIL ACERO	12	C/U

OBS: Cerradura para plegadiza en la pag.63



ACCESORIOS PARA MANIJAS-MANIJONES

Código	Descripción	X Caja	U.M.
2650101	TORNILLO PASANTE BR.PULIDO	20	C/U
2650102	TORNILLO PASANTE BR.PLATIL	20	C/U
3862001	CLAVIJA PARA MANIJA DORADA	1	CIEN
3862002	CLAVIJA PARA MANIJA NIQUELADA	1	CIEN



ROSETAS PARA MANIJAS

Código	Descripción	X Caja	U.M.
	ROSETAS DE CHAPA		
2250721	REDONDA HIERRO BRONCEADO	50	C/U
22507210	REDONDA HIERRO NIQUELADO	50	C/U
PULIDO PLATIL	ROSETAS DE BRONCE		
2250392	22503920 REDONDA 42 MM	12	C/U
22503921	22503922 REDONDA 42 MM CIEGA	12	C/U
2250394	22503940 REDONDA 48 MM	12	C/U
22503941	22503942 REDONDA 48 MM CIEGA	12	C/U
2250396	22503960 CUADRADA 42 MM	12	C/U
2500104	25001040 RECTANGULAR(DELTA)	12	C/U



BOCALLAVES

Código	Descripción	X Caja	U.M.
	BOCALLAVES DE CHAPA		
22507212	REDONDA HIERRO BRONCEADO	50	C/U
22507211	REDONDA HIERRO NIQUEL	50	C/U
	BOCALLAVES DE BRONCE		
PULIDO PLATIL	CUADRADOS		
2250356	22503560 42 MM AJUSTE COMUN	12	C/U
2250374	22503740 42 MM AJUSTE UNIVERS.	12	C/U
	REDONDOS		
2250352	22503520 42 MM AJUSTE COMUN	12	C/U
2250370	22503700 42 MM AJUSTE UNIVERS.	12	C/U
2250354	22503540 48 MM AJUSTE COMUN	12	C/U



2250372	22503720	48 MM AJUSTE UNIVERS.	12	C/U
2250360	22503600	42 MM C/FILETE COMUN	12	C/U
2250370	22503700	42 MM C/FILETE UNIV.	12	C/U
2250361	22503610	48 MM C/FILETE COMUN	12	C/U
2250380	22503800	48 MM C/FILETE UNIV.	12	C/U
2250386	22503860	60 MM PARA CILINDRO	12	C/U
RECTANGULARES (DELTA)				
2500103	25001032	AJUSTE UNIVERSAL	12	C/U
25001030	25001033	AJUSTE COMUN	12	C/U
ESTAMPADOS LISOS				
3012400	30124000	50X50 UNIVERSAL	12	C/U
3012401	30124010	50X70 UNIVERSAL	12	C/U
3012402	30124020	50X90 UNIVERSAL	12	C/U
3012403	30124030	50X90 UNIV.TIPO ACYTRA (AJUSTE DESPLAZADO)	12	C/U



BOCALLAVES CON TAPA

Código	Descripción	X Caja	U.M.
PULIDO PLATIL			
2250382	22503820	REDONDO UNIVERSAL	12 C/U
2250384	22503840	CUADRADO UNIVERSAL	12 C/U
3012404	30124040	50X50 UNIVERSAL	12 C/U
3012405	30124050	50X70 UNIVERSAL	12 C/U
3012406	30124060	50X90 UNIVERSAL	12 C/U
3012407	30124070	50X90 UNIV.TIPO ACYTRA	12 C/U

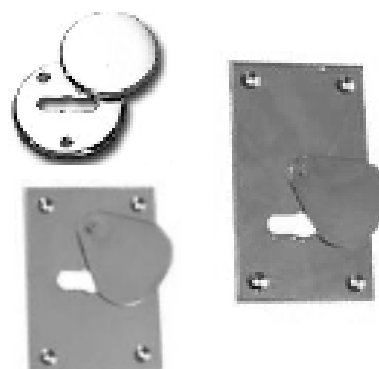

HERRAJES PARA BAÑO

Código	Descripción	X Caja	U.M.
2250730	POMO INTERIOR PULIDO	12	C/U
22507300	POMO INTERIOR PLATIL	12	C/U
2250732	BOCALLAVE PULIDO	12	C/U
22507320	BOCALLAVE PLATIL	12	C/U
2500210	LLAVIN PARA BAÑO (PARA 1/4") PUL	12	C/U
2500211	LLAVIN PARA BAÑO (PARA 1/4") PUL	12	C/U

OBS: Cerrojo de baño en la pag.60
 Coraza libre-ocupado y placas indicadoras en pag.191
 Cerraduras:Prive 105/106/109; Kallay 505/506/502



CUBETAS DE BRONCE FUNDIDO

herbron

Código		Descripción	X Caja	U.M.
PULIDO	PLATIL	RECTANGULAR		
2400502	2400504	30X90 SIN BOCA	25	C/U
2400501	2400503	30X90 CON BOCA	25	C/U
2400506	2400508	40X120 SIN BOCA	25	C/U
2400505	2400507	40X120 CON BOCA	25	C/U
2400509	24005091	33X90 CON BOCA	25	C/U
24005090	24005092	33X90 SIN BOCA	25	C/U
REDONDA				
2433010	24330100	REDONDA 40 MM	20	C/U
2433011	24330110	REDONDA 50 MM	20	C/U
REDONDA CON ARO				
2433315	24333150	REDONDA 40 MM	20	C/U
2433316	24333160	REDONDA 50 MM	20	C/U

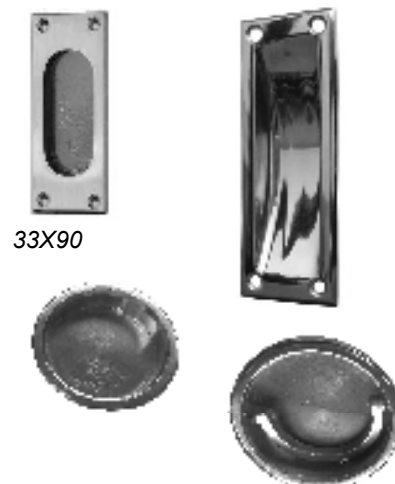

CUBETAS ESTAMPADAS

Código		Descripción	X Caja	U.M.
2400519	RECTANG.	30X90 ACERO CON BOCA	25	C/U
2400520	RECTANG.	30X90 ACERO SIN BOCA	25	C/U
2400521	RECTANG.	45X110 ACERO CON BOCA	25	C/U
2400522	RECTANG.	45X110 ACERO SIN BOCA	25	C/U
2400511	RECTANG.	30X90 BR PULIDO C/B	25	C/U
2400512	RECTANG.	30X90 BR PULIDO S/B	25	C/U
2400515	RECTANG.	45X110 BR PULIDO C/B	25	C/U
2400516	RECTANG.	45X110 BR PULIDO S/B	25	C/U
2021010	RECTANG.	20X100 CIEGA ACERO	25	C/U
2021011	RECTANG.	20X100 C/B ACERO	25	C/U



CUBETAS PLÁSTICAS

Código		Descripción	X Caja	U.M.
2201211	REDONDA	35 MM ORO	50	C/U
2201212	REDONDA	35 MM CROMO	50	C/U
2201213	REDONDA	35 MM BLANCA	50	C/U
2201214	REDONDA	35 MM NEGRA	50	C/U
2201215	REDONDA	MEDIA TAPA CROMO	50	C/U
2201216	REDONDA	MEDIA TAPA ORO	50	C/U
2201217	REDONDA	MEDIA TAPA BLANCA	50	C/U
2201218	REDONDA	MEDIA TAPA NEGRA	50	C/U
3010327	REDONDA	40 MM DORADA	50	C/U
3010328	REDONDA	40 MM CROMADA	50	C/U
3010329	REDONDA	40 MM NEGRA	50	C/U
3010325	REDONDA	50 MM DORADA	50	C/U
3010326	REDONDA	50 MM CROMADA	50	C/U
3010324	REDONDA	50 MM NEGRA	50	C/U
3010301	RECTANG.	30X90 CROMO C/BOCA	50	C/U
3010302	RECTANG.	30X90 CROMO S/BOCA	50	C/U
3010303	RECTANG.	30X90 ORO C/BOCA	50	C/U
3010304	RECTANG.	30X90 ORO S/BOCA	50	C/U



CUBETAS DE CHAPA ESTAMPADA

Código		Descripción	X Caja	U.M.
NIQUEL	DORADA			
2400532	2400530	30X90 CON BOCA	25	C/U
2400533	2400531	30X90 SIN BOCA	25	C/U
2400536	2400534	45X110 CON BOCA	25	C/U
2400537	2400535	45X110 SIN BOCA	25	C/U

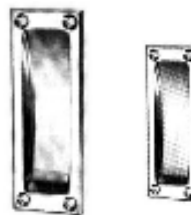

CUBETAS PARA MUEBLES

Código	Descripción	X Caja	U.M.
4520360	CUBETA C40 CR.MATE/NIQ MATE OBS: Medida entre centros 128 mm	12	C/U
43600120	CUBETA MAXI ALUMINIO 160 MM OBS: Medida total	12	C/U
3330401	REDONDA 35 MM CROMO	25	C/U
3330402	REDONDA 35 MM CROMO MATE	25	C/U
3330403	REDONDA 35 MM DORADA	25	C/U
3330404	REDONDA 35 MM NIQUEL MATE OBS: 35 mm es el diámetro de la perforacion	25	C/U
3330410	REDONDA C/PLACA CROMO MATE	25	C/U
3330411	REDONDA C/PLACA DORADA	25	C/U
3330412	REDONDA C/PLACA NIQUEL MATE	25	C/U
3330413	REDONDA C/PLACA CROMO	25	C/U



TIRADORES DE MADERA

Código	Descripción	X Caja	U.M.
MARA	ROBLE		
3170601	3170602	SANTA CLARA 34 MM	50 C/U
3170604	3170605	SANTA CLARA 30 MM	50 C/U
3170607	3170608	PINAMAR	50 C/U
3170613	3170614	MIRAMAR 34 MM	50 C/U
3170619	3170620	TORREON 30 MM	50 C/U
3170622	3170623	TORREON 21 MM	50 C/U
3170625	3170626	NECOCHEA	50 C/U
3170628	3170629	MAR DEL SUR 34 MM	50 C/U
3170634	3170635	LUCILA 40 MM	50 C/U
3170637	3170638	LUCILA 34 MM	50 C/U
3170640	3170641	MONACO	50 C/U
3170643	3170644	GESSELL 34 MM	50 C/U
3170646	3170647	GESSELL 30 MM	50 C/U
3170655	3170656	STA ROSA 41 MM	50 C/U
3170658	3170659	STA ROSA 34 MM	50 C/U
3170661	3170662	STA ROSA 26 MM	50 C/U
3170664	3170665	STA ROSA 21 MM	50 C/U
3170673	3170674	TUYU 34 MM	50 C/U
3170670	3170671	TUYU 30 MM	50 C/U
3170667	3170668	TUYU 21 MM	50 C/U
3170676	3170677	MARDEL	50 C/U
3170679	3170680	CARILO 30 MM	50 C/U
3170682	3170683	CARILO 20 MM	50 C/U
3170649	3170650	COSTA AZUL	50 C/U
3170546	3170547	PLAQUETA CON BOCA	50 C/U
3170548	3170549	PLAQUETA CIEGA	50 C/U



Roble Mara



MANIJAS – CUBETAS DE MADERA

MARA	ROBLE		
3170501	3170502	FLORENCIA 128	25 C/U
3170503	3170504	FLORENCIA 112	25 C/U
3170505	3170506	FLORENCIA 80	25 C/U
3170507	3170508	FLORENCIA 64	25 C/U
3170511	3170512	FLORENCIA 108 FINA	25 C/U
3170513	3170514	OVAL 96	25 C/U
3170515	3170516	GRANADA 114	25 C/U
3170517	3170518	GRANADA 97	25 C/U
3170519	3170520	VENECIA 140	25 C/U
3170521	3170522	VENECIA 112	25 C/U
3170523	3170524	VENECIA 90	25 C/U
3170525	3170526	IBIZA 112	25 C/U



3170527	3170528	IBIZA 80	25	C/U
3170529	3170530	FANTASIA 112	25	C/U
3170531	3170532	FANTASIA 80	25	C/U
3170535	3170536	CAPRI	25	C/U
3170539	3170540	IGUAZU	25	C/U
3170569	3170570	VALERIA	25	C/U
3170581	3170580	EIFFEL 128	25	C/U
3170583	3170582	EIFFEL 80	25	C/U
3170585	3170584	EIFFEL 64	25	C/U
3170591	3170590	MILAN	25	C/U



Venecia



Ibiza



Fantasia



Valeria



Milan



Capri



Eiffel



Iguazu

TORRECITAS PARA MUEBLES

Código	Descripción	X Caja	U.M.
MARA	ROBLE		
3170565	3170566 CHICA	50	C/U
3170567	3170568 GRANDE	50	C/U



LINEA COMBINADA MADERA-METAL

Código	Descripción	X Caja	U.M.
COMBINADA HAYA – CROMO MATE			
3170450	MANIJA SOL 64 MM ROBLE	25	C/U
31704500	MANIJA SOL 64 MM MARA	25	C/U
31704501	MANIJA SOL 64 MM HAYA	25	C/U
3170451	MANIJA SOL 96 MM ROBLE	25	C/U
31704510	MANIJA SOL 96 MM MARA	25	C/U
31704511	MANIJA SOL 96 MM HAYA	25	C/U
3170452	MANIJA SOL 128 MM ROBLE	25	C/U
31704520	MANIJA SOL 128 MM MARA	25	C/U
31704521	MANIJA SOL 128 MM HAYA	25	C/U
3170421	MANIJA VARIANT 160 MM ROBLE	25	C/U
31704210	MANIJA VARIANT 160 MM MARA	25	C/U
31704211	MANIJA VARIANT 160 MM HAYA	25	C/U



Sol



Variant



Aceituna



Santa clara



Ratoncito

2353299	TIRADOR RATONCITO HAYA	1	C/U
---------	------------------------	---	-----



TIRADORES EN ZAMAK

Código	Descripción	X Caja	U.M.
3090060	TIRADOR OVAL 25 MM CROMO	50	C/U
3090061	TIRADOR OVAL 25 MM CR.MATE	50	C/U
30900610	TIRADOR OVAL 25 MM NIQ.MATE	50	C/U
3090062	TIRADOR OVAL 25 MM ORO	50	C/U
3090063	TIRADOR OVAL 25 MM BLANCO	50	C/U
3090064	TIRADOR OVAL 25 MM NEGRO	50	C/U
3090101	TIRADOR OVAL 30 MM CROMO	50	C/U
3090102	TIRADOR OVAL 30 MM CR. MATE	50	C/U
3090103	TIRADOR OVAL 30 MM ORO	50	C/U
3090104	TIRADOR OVAL 30 MM BLANCO	50	C/U
3090105	TIRADOR OVAL 30 MM NEGRO	50	C/U
3090106	TIRADOR OVAL 30 MM NIQ. PERL	50	C/U
3090107	TIRADOR BALA CROMO	50	C/U
3090108	TIRADOR BALA CR. MATE	50	C/U
3090109	TIRADOR BALA ORO	50	C/U
3090110	TIRADOR BALA NEGRO	50	C/U
3090112	TIRADOR BALA NIQ. PERL.	50	C/U
3090113	TIRADOR LOSSA CROMO	50	C/U
3090114	TIRADOR LOSSA CR. MATE	50	C/U
3090115	TIRADOR LOSSA ORO	50	C/U
3090116	TIRADOR LOSSA NEGRO	50	C/U
3090118	TIRADOR LOSSA NIQ. PERL.	50	C/U
3090150	TIRADOR JULE CROMO	50	C/U
3090151	TIRADOR JULE CROMO MATE	50	C/U
30901510	TIRADOR JULE NIQUEL MATE	50	C/U
3090152	TIRADOR JULE ORO	50	C/U
4520370	TIRADOR R6 CROMO MATE	50	C/U
4520371	TIRADOR R4 CROMO MATE	50	C/U
4520373	TIRADOR GOTA G15 CROMO MATE	50	C/U
4520377	TIRADOR GOTA C14 CROMO MATE	50	C/U



Oval 25 mm



Oval 30 mm



Bala



Lossa



Jule



R4



R6



G15



C14

MANIJAS EN ZAMAK

Código	Descripción	X Caja	U.M.
LINEA OVAL			
3090201	MANIJA OVAL 96 mm CROMO	50	C/U
3090202	MANIJA OVAL 96 mm CR. MATE	50	C/U
3090203	MANIJA OVAL 96 mm BLANCA	50	C/U
30902030	MANIJA OVAL 96 mm NEGRA	50	C/U
3090204	MANIJA OVAL 96 mm ORO	50	C/U
3090206	MANIJA OVAL 96 mm NIQ MATE	50	C/U
3090207	MANIJA OVAL 128 mm CROMO	50	C/U
3090208	MANIJA OVAL 128 mm CR. MATE	50	C/U
3090209	MANIJA OVAL 128 mm BLANCA	50	C/U
30902090	MANIJA OVAL 128 mm NEGRA	50	C/U





3090210	MANIJA OVAL 128 mm ORO	50	C/U
3090211	MANIJA OVAL 128 mm PELTRE	50	C/U
3090212	MANIJA OVAL 128 mm NIQ. PERL.	50	C/U

LINEA ARCO

3090213	MANIJA ARCO 64 CROMO	50	C/U
3090214	MANIJA ARCO 64 CROMO MATE	50	C/U
3090215	MANIJA ARCO 64 NEGRA	50	C/U
3090216	MANIJA ARCO 64 ORO	50	C/U
3090217	MANIJA ARCO 64 PELTRE	50	C/U
3090218	MANIJA ARCO 64 NIQUEL MATE	50	C/U
3090219	MANIJA ARCO 96 CROMO	50	C/U
3090220	MANIJA ARCO 96 CROMO MATE.	50	C/U
3090221	MANIJA ARCO 96 NEGRA	50	C/U
3090222	MANIJA ARCO 96 ORO	50	C/U
3090223	MANIJA ARCO 96 PELTRE	50	C/U
3090224	MANIJA ARCO 96 NIQ. PERL.	50	C/U



COMBINADA CROMO-CROMO MATE

3090250	MANIJA 128 COMBINADA	50	C/U
3090251	MANIJA 160 COMBINADA	50	C/U
3090252	MANIJA 192 COMBINADA	50	C/U



LINEA BARRAL

3090260	MANIJA BARRAL 64/96 CR MATE	50	C/U
30902600	MANIJA BARRAL 64/96 NIQ MATE	50	C/U
30902601	MANIJA BARRAL 64/96 CROMO	50	C/U
3090261	MANIJA BARRAL 96/128 CR MATE	50	C/U
30902610	MANIJA BARRAL 96/128 NIQ MATE	50	C/U
30902611	MANIJA BARRAL 96/128 CROMO	50	C/U
3090262	MANIJA BARRAL 128/192 CR MATE	50	C/U
30902620	MANIJA BARRAL 128/192 NIQ MATE	50	C/U
30902621	MANIJA BARRAL 128/192 CROMO	50	C/U
3090263	MANIJA BARRAL 160/224 CR MATE	50	C/U
30902630	MANIJA BARRAL 160/224 NIQ MATE	50	C/U
30902631	MANIJA BARRAL 160/224 CROMO	50	C/U
3090264	MANIJA BARRAL 192/256 CR MATE	50	C/U
30902640	MANIJA BARRAL 192/256 NIQ MATE	50	C/U
30902641	MANIJA BARRAL 192/256 CROMO	50	C/U
3090265	MANIJA BARRAL 224/288 CR MATE	50	C/U
30902650	MANIJA BARRAL 224/288 NIQ MATE	50	C/U
30902651	MANIJA BARRAL 224/288 CROMO	50	C/U
3090266	MANIJA BARRAL 256/320 CR MATE	50	C/U
30902660	MANIJA BARRAL 256/320 NIQ MATE	50	C/U
30902661	MANIJA BARRAL 256/320 CROMO	50	C/U
3090267	MANIJA BARRAL 288/352 CR MATE	50	C/U
30902670	MANIJA BARRAL 288/352 NIQ MATE	50	C/U
30902671	MANIJA BARRAL 288/352 CROMO	50	C/U
3090268	MANIJA BARRAL 320/384 CR MATE	50	C/U
30902680	MANIJA BARRAL 320/384 NIQ MATE	50	C/U
30902681	MANIJA BARRAL 320/384 CROMO	50	C/U





LINEAS VARIAS EN ZAMAK

4520300	B21 128 MM CROMO MATE	30	C/U
4520301	B21 128 MM NIQUEL MATE	30	C/U
4520100	JC 25 160 MM CROMO MATE	10	C/U
4520101	JC 25 160 MM NIQUEL MATE	10	C/U
4520210	CB5 128 MM CROMO MATE	25	C/U
4520211	CB5 128 MM NIQUEL MATE	25	C/U
4520220	L6 128 MM CROMO MATE	30	C/U
4520221	L6 128 MM NIQUEL MATE	30	C/U
4520223	R1 96 MM CROMO MATE	24	C/U
4520224	R1 96 MM NIQUEL MATE	24	C/U
4520225	R2 128 MM CROMO MATE	30	C/U
4520226	R2 128 MM NIQUEL MATE	30	C/U
4520350	L25 160 MM CROMO MATE	15	C/U
4520351	L25 160 MM NIQUEL MATE	15	C/U
4520352	TR 128 MM CROMO MATE	30	C/U
4520353	TR 128 MM NIQUEL MATE	30	C/U
4520355	R12 160 MM CROMO MATE	25	C/U
4520356	R12 160 MM NIQUEL MATE	25	C/U



LINEA MAREA

3170440	64 MM CROMO MATE	25	C/U
3170441	64 MM ORO	25	C/U
3170436	64 MM NEGRA	25	C/U
3170437	64 MM NIQUEL MATE	25	C/U
3170435	64 MM CROMO	25	C/U
3170442	96 MM CROMO MATE	25	C/U
3170443	96 MM ORO	25	C/U
3170444	96 MM NEGRA	25	C/U
3170446	96 MM NIQUEL MATE	25	C/U
3170445	96 MM CROMO	25	C/U



LINEA MERLOT

3170470	96 MM CROMO MATE	25	C/U
3170471	128 MM CROMO MATE	25	C/U
3170472	160 MM CROMO MATE	25	C/U
3170473	192 MM CROMO MATE	25	C/U



LINEAS FINAS EN ZAMAK

Código	Descripción	X Caja	U.M.
LINEA VALENCIA			
ORO	COBRE		
3100201	3100208 VERTICAL CON BOCA	25	C/U
3100202	3100209 VERTICAL CIEGA	25	C/U
3100203	3100210 HORIZONTAL MEDIANA	25	C/U
3100204	3100211 HORIZONTAL CHICA	25	C/U
3100205	3100212 VERTICAL MEDIANA	25	C/U
3100206	3100213 VERTICAL CHICA	25	C/U



LINEA JAI			
ORO	COBRE	BARROCO	
3100501	3100508	3100515 MANIJA	25 C/U
3100503	3100510	3100516 CON BOCA	25 C/U
3100504	3100511	3100517 CIEGA	25 C/U
3100507	3100513	3100518 C/ROSETA	25 C/U



LINEA SABA			
ORO	BARROCO		
3101001	3101008 TIRADOR SOLO	25	C/U
3101002	3101010 C/PLACA MEDIANA	25	C/U
3101003	3101012 C/PLACA VERT C/BOCA	25	C/U
31010030	3101013 C/PLACA VERT CIEGO		
3101004	3101014 MANIJA VOLCABLE	25	C/U
3101005	3101015 TIRADOR RED.25 MM	25	C/U
3101006	3101016 TIRADOR RED.30 MM	25	C/U
3101007	3101017 BOCALLAVE	25	C/U



LINEA MAZAL			
ORO	BARROCO		
3101530	3101540 MANIJA N.1 96 MM	25	C/U
3101531	3101541 MANIJA N.2 64 MM	25	C/U



LINEA TOV			
ORO	BARROCO		
3101501	3101503 MANIJA N.1 96 MM	25	C/U
3101502	3101504 MANIJA N.2 64 MM	25	C/U



LINEA COLONIAL			
ORO	COBRE		
3100401	3100405 CHICO 20 MM	25	C/U
3100402	3100406 MEDIANO 25 MM	25	C/U
3100403	3100407 GRANDE 40 MM	25	C/U





MANIJAS PUENTE HIERRO

Código	Descripción	X Caja	U.M.
30101010	8 X 55 EPOXI BLANCO	24	C/U
30101011	8 X 55 EPOXI NEGRO	24	C/U
30101012	8 X 55 EPOXI GRIS	24	C/U
30101020	8 X 80 EPOXI BLANCO	24	C/U
30101021	8 X 80 EPOXI NEGRO	24	C/U
30101022	8 X 80 EPOXI GRIS	24	C/U
30101030	8 X 105 EPOXI BLANCO	24	C/U
30101031	8 X 105 EPOXI NEGRO	24	C/U
30101032	8 X 105 EPOXI GRIS	24	C/U
3010120	8 X 55 CROMO	24	C/U
3010121	8 X 55 CROMO MATE	24	C/U
4520412	8 X 80 CROMO	60	C/U
45204120	8 X 80 CROMO MATE	60	C/U
3010124	8 X 105 CROMO	24	C/U
3010125	8 X 105 CROMO MATE	24	C/U
4520402	8 X 64 CROMO	60	C/U
45204020	8 X 64 CROMO MATE	60	C/U
4520422	8 X 96 CROMO	60	C/U
45204220	8 X 96 CROMO MATE	60	C/U
4520432	8 X 128 CROMO	36	C/U
45204320	8 X 128 CROMO MATE	36	C/U



OBS: La medida que se indica es diámetro x distancia entre centros (mm)



MANIJAS EN ACERO INOXIDABLE

Código	Descripción	X Caja	U.M.
9043330	BARRAL 160 MM – 96 mm	25	C/U
9043331	BARRAL 192 MM –128 mm	25	C/U
9043332	BARRAL 224 MM –160 mm	25	C/U
9043333	BARRAL 256 MM –192 mm	25	C/U
9043334	BARRAL 288 MM –224 mm	25	C/U
9043335	BARRAL 384 MM –320 mm	25	C/U
9043350	TIRADOR ESFERICO 20 MM	25	C/U
9043351	TIRADOR ESFERICO 25 MM	25	C/U
9043352	TIRADOR ESFERICO 30 MM	25	C/U
9043353	TIRADOR ESFERICO 34 MM	25	C/U
9043360	TIRADOR CILINDRICO 15 MM	25	C/U
9043361	TIRADOR CILINDRICO 20 MM	25	C/U
9043362	TIRADOR CILINDRICO 25 MM	25	C/U
9043363	TIRADOR CILINDRICO 30 MM	25	C/U

OBS: Largo total-medida entre centros



MANIJAS DE ALUMINIO



Código	Descripción	X Caja	U.M.
9041980	PERFIL PERA 32 MM	20	C/U
9041981	PERFIL PERA 64 MM	20	C/U
9041982	PERFIL PERA 96 MM	20	C/U
9041983	PERFIL PERA 128 MM	20	C/U
9041984	PERFIL PERA 192 MM	20	C/U
9041985	PERFIL PERA 288 MM	20	C/U
9041986	PERFIL PERA 352 MM	20	C/U
OBS: La medida indicada es entre centros.			
2353194	PUENTE 140X36	20	C/U
2353195	PUENTE 204X36	20	C/U
2353196	PUENTE 300X36	20	C/U
OBS: La medida indicada es la total.			
2353191	PERFIL L 44X29	20	C/U
2353192	PERFIL L 140X29	20	C/U
OBS: La medida indicada es la total.			
2353187	PERFIL CURVO 44X32	20	C/U
2353188	PERFIL CURVO 140X32	20	C/U
2353189	PERFIL CURVO 172X32	20	C/U
OBS: La medida indicada es la total.			



MANIJAS DE ALUMINIO



Código	Descripción	X Caja	U.M.
4520380	MANIJA ARCO 10X128	15	C/U
4520381	MANIJA ARCO 15X128	15	C/U
4520382	MANIJA ARCO 25X128	15	C/U
4520383	MANIJA ARCO 35X128	15	C/U
4520384	MANIJA ARCO 45X128	15	C/U
OBS: La medida indicada es ancho x entre centros.			
4520357	PERFIL "L" 96 MM	15	C/U
45203570	PERFIL "L" 128 MM	15	C/U
45203571	PERFIL "L" 160 MM	15	C/U
OBS: La medida indicada es entre centros.			



TIRADORES LISOS BRONCE PULIDO

Código	Descripción	X Caja	U.M.
PULIDO PLATIL ESFERICO			
2251001	22510010 25 MM SOLO	12	C/U
2251002	22510020 25 MM C/ROSETA	12	C/U
2251003	22510030 C/PLAQUETA CIEGA	12	C/U
22510031	22510032 C/PLAQUETA C/BOCA	12	C/U
PULIDO PLATIL COPITA			
2251010	22510100 SOLO	12	C/U
2251011	22510110 C/ROSETA	12	C/U
2251012	22510120 C/PLAQUETA CIEGA	12	C/U
22510121	22510122 C/PLAQUETA C/BOCA	12	C/U



PULIDO	PLATIL	CONVEXO LISO		
2251015	22510150	SOLO	12	C/U
2251016	22510160	C/ROSETA	12	C/U
2251017	22510170	C/PLAQUETA CIEGA	12	C/U
22510171	22510172	C/PLAQUETA C/BOCA	12	C/U
PULIDO	PLATIL	CONVEXO CON FILETE		
2251020	22510200	SOLO	12	C/U
2251021	22510210	C/ROSETA	12	C/U
2251022	22510220	C/PLAQUETA CIEGA	12	C/U
22510221	22510222	C/PLAQUETA C/BOCA	12	C/U
PULIDO	PLATIL	BASES SOLAS		
2251026	22510260	ROSETA 30 MM	12	C/U
2251027	22510270	PLAQUETA CIEGA	12	C/U
22510271	22510272	PLAQUETA C/BOCA	12	C/U



TIRADORES CON FILETE BRONCE CEPILLADO

Código	Descripción	X Caja	U.M.
3020101	REDONDO 18MM CEPILLADO	50	C/U
3020105	REDONDO 18MM PLATIL	50	C/U
3020102	REDONDO 25MM CEPILLADO	20	C/U
3020106	REDONDO 25MM PLATIL	20	C/U
3020103	REDONDO 30MM CEPILLADO	20	C/U
3020107	REDONDO 30MM PLATIL	20	C/U
3020104	REDONDO 35MM CEPILLADO	20	C/U
3020108	REDONDO 35MM PLATIL	20 <td C/U	
3020501	PLAQUETA 30X85 CEPILL.C/BOCA	60	C/U
3020502	PLAQUETA 30X85 CEPILL.CIEGA	60	C/U
3020503	PLAQUETA 30X85 PLATIL C/BOCA	60	C/U
3020504	PLAQUETA 30X85 PLATIL CIEGA	60	C/U



BOCALLAVES PARA MUEBLES

Código	Descripción	X Caja	U.M.
3020505	15 x 35MM BCE CEPILLADO	50	C/U
3020506	15 x 35MM BCE PLATIL	50	C/U
2490301	EMBUTIR CON BORDE BRONCE PUL	20	C/U
2490302	EMBUTIR SIN BORDE BRONCE PUL	20	C/U
2251025	REDONDO 30 MM BRONCE PULIDO	20	C/U
22510250	REDONDO 30 MM BRONCE PLATIL	20	C/U



CABEZAS PARA REVESTIR LLAVES

Código	Descripción	X Caja	U.M.
2490401	CALADA	50	C/U
2490402	DOS CUERNITOS	50	C/U

OBS: En bronce pulido



TIRADORES PLASTICOS

Código	Descripción	X Caja	U.M.
2201001	ESFERA C/CUELLO 20 MM BLANCO	50	C/U
22010010	ESFERA C/CUELLO 20 MM NEGRO	50	C/U
2201002	ESFERA C/CUELLO 20 MM ORO	50	C/U
2201003	ESFERA C/CUELLO 20 MM CROMO	50	C/U
2201011	ESFERA C/CUELLO 25 MM BLANCO	50	C/U
22010110	ESFERA C/CUELLO 25 MM NEGRO	50	C/U
2201012	ESFERA C/CUELLO 25 MM ORO	50	C/U
2201013	ESFERA C/CUELLO 25 MM CROMO	50	C/U
2201020	RED. 30 MM BLANCO CENTRO ORO	50	C/U
2201021	RED. 30 MM NEGRO CENTRO ORO	50	C/U

**MANIJAS PLASTICAS DE APLICAR**

Código	Descripción	X Caja	U.M.
3140250	SIMIL MADERA PETIRIBI	50	C/U
3140251	SIMIL MADERA NOGAL	50	C/U

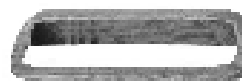

HERRAJES PARA MUEBLES

LINEA "ESTAMP"



Código	Descripción	Acabado	X Caja	U.M.
3397000	CUBETA CUADRADA 45 MM	CR.MATE	25	C/U
3397001	CUBETA CUADRADA 35 MM	CR.MATE	25	C/U
3397002	CUBETA 102 X 36	CR.MATE	25	C/U
3397003	BARRAL RECTO 224 MM	CR.MATE	25	C/U
3397006	BARRAL RECTO 128 MM	CR.MATE	25	C/U
3397007	BARRAL PLANO 192	NIQ.CEP	25	C/U
3397017	MANIJA "S"	BR.VIEJO	25	C/U
3397019	BARRAL PLANO 192 MM	NIQ.CEP	25	C/U
3397020	BARRAL PLANO 128 MM	NIQ.CEP	25	C/U
3397021	BARRAL RECTO 96 MM	CR.MATE	25	C/U
3397023	TIRADOR RECTANGULAR	CR.MATE	25	C/U
3397024	TIRADOR RECT. 10 X 10	CR.MATE	25	C/U
3397027	TIRADOR DESPLAZADO	CR.MATE	25	C/U
3397030	TIRADOR "S"	BR.VIEJO	25	C/U
3397031	MANIJA COUNTRY 128 MM	NIQ.SAT	25	C/U
3397032	MANIJA COUNTRY 128 MM	BR.RUST.	25	C/U
3397033	MANIJA COUNTRY 96 MM	NIQ.SAT	25	C/U
3397034	MANIJA COUNTRY 96 MM	BR.RUST.	25	C/U
3397035	TIRADOR COUNTRY 34X34	NIQ.SAT	25	C/U
3397036	TIRADOR COUNTRY 34X34	BR.RUST.	25	C/U
3397037	TIRADOR COUNTRY 29X29	NIQ.SAT	25	C/U
3397038	TIRADOR COUNTRY 29X29	BR.RUST	25	C/U
3397039	MANIJA COUNTRY 128 MM	NIQ.SAT	25	C/U
3397040	MANIJA COUNTRY 128 MM	BR.RUST	25	C/U
3397041	MANIJA COUNTRY 96 MM	NIQ.SAT	25	C/U
3397042	MANIJA COUNTRY 96 MM	BR.RUST.	25	C/U
3397106	TIRADOR RANA 35 MM	VERDE	25	C/U
3397202	CUBETA DE APLICAR ALUM	CR.MATE	25	C/U
3397208	MANIJA BARRAL 96 MM	CR.MATE	25	C/U
3397212	MANIJA CURVA 32 MM	CR.MATE	25	C/U
3397214	MANIJA CURVA 32 MM	NIQ.SAT	25	C/U
3397216	MANIJA BARRAL 32 PERA	CR.MATE	25	C/U
3397228	MANIJA OVAL 96 MM	CR.MATE	25	C/U
3397230	MANIJA ARCO 96 MM	CR.MATE	25	C/U
3397232	MANIJA ARCO 64 MM	CR.MATE	25	C/U
3397234	TIR BALA 12 MM	CR.MATE	25	C/U
3397236	TIR ESFERA 18 MM	CR.MATE	25	C/U
3397238	TIRADOR ESFERA 18 MM	NIQ.CEP	25	C/U
3397240	TIRADOR ESFERA 13 MM	CR.MATE	25	C/U
3397248	TIRADOR UÑA 40X18	CR.MATE	25	C/U
3397250	TIRADOR C/RANURA 20X20	CR.MATE	25	C/U
3397252	TIRADOR CHANFLE 20 MM	CR.MATE	25	C/U
3397254	TIRADOR DESPL.30X22 MM	CR.MATE	25	C/U
3397256	TIR LISO 16 MM	CR.MATE	25	C/U
3397258	TIR LISO 16 MM	CR.MATE	25	C/U
3397260	TIRADOR CURVO30X19 MM	CR.MATE	25	C/U



97000/1



97002

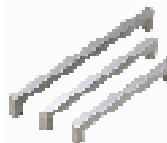

97003-6



97007



97017



97019/20



97021



97023



97024



97027



97030



97031-34



97035-38



97039-40



97106



97202



97212



97208



97234



97214



























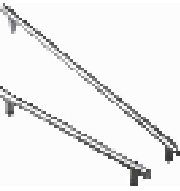

97216



97228



97230/2

3397280	BARRAL ESP 128 ACERO	25	C/U			
3397281	BARRAL ESP 160 ACERO	25	C/U			
3397282	BARRAL ESP 192 ACERO	25	C/U			
3397284	BARRAL ESP 288 ACERO	25	C/U	97248	97236	97238-40
3397330	MANIJA ESTILO 96 MM	DORADA	25	C/U		
3397334	MANIJA ESTILO 96 MM.	BR.VIEJO	25	C/U		
3397351	MANIJA ARCO 96 MM.	NIQ.CEP.	25	C/U		
3397370	MANIJA BARRAL 178 MM.	ACERO	25	C/U		97256
3397371	MANIJA BARRAL 210 MM.	ACERO	25	C/U	97250	
3397372	MANIJA BARRAL 274 MM.	ACERO	25	C/U		
3397380	MANIJA ARCO 64 MM.	DORADO	25	C/U		
3397381	MANIJA ARCO 64 MM.	NIQ CEP	25	C/U		97252
3397386	MANIJA ARCO 96 MM.	DORADO	25	C/U	97258	97260
3397387	MANIJA ARCO 96 MM.	NIQ.CEP.	25	C/U		
3397418	TIRADOR 25 MM.C/STRASS	DORADO	25	C/U		
3397420	TIRADOR 30 MM.C/STRASS	DORADO	25	C/U		97380-6
3397440	TIRADOR 30 MM.PLANO	NIQ.CEP.	25	C/U		
3397450	TIRADOR 25 MM.OVAL	DORADO	25	C/U		97280-84
3397451	TIRADOR 25 MM.OVAL	NIQ.CEP.	25	C/U	97330	
3397452	TIRADOR 25 MM.OVAL	CROMO	25	C/U		
3397454	TIRADOR 25 MM.OVAL	BLANCO	25	C/U		
3397458	TIRADOR 31 MM.OVAL	DORADO	25	C/U	97334	
3397459	TIRADOR 31 MM.OVAL	NIQ.CEP.	25	C/U		97351
3397460	TIRADOR 31 MM.OVAL	CROMO	25	C/U		
3397462	TIRADOR 31 MM.OVAL	BLANCO	25	C/U	97506	
3397506	MANIJA 96 MM.OVAL	CR.MATE	25	C/U		
3397526	MANIJA 96 MM.OVAL	NIQ.CEP.	25	C/U		
3397535	MANIJA 64 MM.OVAL	DORADO	25	C/U	97526	
3397536	MANIJA 64 MM.OVAL	NIQ.CEP.	25	C/U		
3397543	MANIJA 96 MM.OVAL	NIQ.CEP.	25	C/U		
3397611	TIRADOR 30 MM.PLANO	NIQ.CEP.	25	C/U	97536	97370/1/2
3397612	TIRADOR 30 MM.PLANO	CROMO	25	C/U		
3397650	CUBETA OVAL 150X40	DORADO	25	C/U		
3397651	CUBETA OVAL 110X36	DORADO	25	C/U		
3397653	CUBETA OVAL 110X36	CROMO	25	C/U	97535	
3397654	CUBETA OVAL 150X40	NIQ.CEP.	25	C/U		97418/20
3397655	CUBETA OVAL 110X36	NIQ.CEP.	25	C/U		97450/62
						
					97611	97612
						97440
						
					97655	97653
						97651

LINEA BOSETTI & MARELLA



Código	Descripción	Acabado	X Caja	U.M.			
3397700	TIRADOR REDONDO 30 MM	FLORENCIA	25	C/U			
3397701	TIRADOR REDONDO 25 MM	FLORENCIA	25	C/U			
3397702	MANIJA VOLCABLE 96 MM	FLORENCIA	25	C/U			
3397703	MANIJA VOLCABLE 64 MM	FLORENCIA	25	C/U	97700	97702	97704
3397704	ARO VOLCABLE 67 MM	FLORENCIA	25	C/U			
3397705	ARO VOLCABLE 55 MM	FLORENCIA	25	C/U			
3397706	TIRADOR VOLCABLE 68 MM	FLORENCIA	25	C/U			
3397710	TIRADOR REDONDO 30 MM	FLORENCIA	25	C/U		97710	
3397711	TIRADOR REDONDO 25 MM	FLORENCIA	25	C/U	97706		97712
3397712	BOCALLAVE 20X57	FLORENCIA	25	C/U			
3397713	BOCALLAVE 15X71	FLORENCIA	25	C/U			
3397800	MJA VOLCABLE GRANDE	FLORENCIA	25	C/U			
3397801	MJA VOLCABLE CHICA	ORO DI VAL.	25	C/U			
3397802	TIRADOR LAGRIMA	ORO DI VAL.	25	C/U	97713		97800/1
3397803	BOCALLAVE FLORENCIA	FLORENCIA	25	C/U			
3397804	ARGOLLA C/PLAQ.CIEGA	ANTICHE	25	C/U		97803	
3397805	ARGOLLA C/PLAQ.C/BOCA	ANTICHE	25	C/U			
3397806	MANIJA P/CAJON CIEGA	ANTICHE	25	C/U			
3397807	MANIJA P/CAJON C/BOCA	ANTICHE	25	C/U			97810
3397808	ARGOLLA C/BASE	ANTICHE	25	C/U	97802		
3397810	ARGOLLA C/PLAQ.CIEGA	FLORENCIA	25	C/U			
3397811	ARGOLLA C/PLAQ C/BOCA	FLORENCIA	25	C/U		97810	
3397812	MANIJA P/CAJON CIEGA	FLORENCIA	25	C/U			
3397813	MANIJA P/CAJON C/BOCA	FLORENCIA	25	C/U			
3397814	ARGOLLA C/BASE	FLORENCIA	25	C/U			
3397816	ARGOLLA C/PLAQ.CIEGA	HIERRO	25	C/U	97812		97814
3397817	ARGOLLA C/PLAQ.C/BOCA	HIERRO	25	C/U			
3397818	MANIJA P/CAJON CIEGA	HIERRO	25	C/U			
3397819	MANIJA P/CAJON C/BOCA	HIERRO	25	C/U			
3397820	ARGOLLA C/BASE	HIERRO	25	C/U			
3397822	CUBETA MEDIA TAPA CHICA	HIERRO	25	C/U	97825		97834
3397825	CUBETA MEDIA TAPA CHICA	DORADA	25	C/U			
3397826	CUBETA MED TAPA GRANDE	HIERRO	25	C/U			
3397830	CUBETA MEDIA TAPA CHICA	ANTICHE	25	C/U			
3397831	CUBETA MEDIA TAPA CHICA	FLORENCIA	25	C/U	97837		
3397832	CUBETA MEDIA TAPA CHICA	CROMO	25	C/U			
3397833	CUBETA MED.TAPA GRANDE	ANTICHE	25	C/U			
3397834	CUBETA MED.TAPA GRANDE	FLORENCIA	25	C/U	97836		
3397836	MANIJA PUENTE 64 MM	ANTICHE	25	C/U			
3397837	MANIJA PUENTE 96 MM	ANTICHE	25	C/U			97838/9
3397838	MANIJA VERTICAL 96 MM	ANTICHE	25	C/U			
3397839	MANIJA VERTICAL 128MM	ANTICHE	25	C/U	97848		
3397848	MANIJA DECORADA 128 MM	FLORENCIA	25	C/U			
3397849	MANIJA DECORADA 96 MM	FLORENCIA	25	C/U			
3397852	MANIJA DECORADA 64 MM	FLORENCIA	25	C/U			97849

3397853	TIRADOR 30 MM.	FLORENCIA	25	C/U				
3397855	TIRADOR 30 MM.	FLORENCIA	25	C/U				97857
3397857	MJA HOR VOLC	CUERO	25	C/U				97853
3397858	MJA VERT C/ARO	CUERO	25	C/U				97858
3397859	TIRADOR C/BASE	CUERO	25	C/U				97859
3397861	LLAMADOR CAB DE LEON	ORO DI VAL.	25	C/U				
3397863	TIR DECORADO 30 MM	FLORENCIA	25	C/U				97860
3397864	TIR DECORADO 25 MM	FLORENCIA	25	C/U				
3397865	TIRADOR 25 MM.	ANTICHE	25	C/U				
3397867	TIRADOR 25 MM.	FLORENCIA	25	C/U				
3397868	TIRADOR 25 MM.	DORADO	25	C/U				
3397870	MJA 96 MM. VOLC.	FLORENCIA	25	C/U				
3397871	MJA 64 MM.VOLC.I	FLORENCIA	25	C/U				
3397872	MJA ARGOLLA VOLC.	FLORENCIA	25	C/U				
3397873	TIRADOR 26 MM.	FLORENCIA	25	C/U				
3397874	TIRADOR 31 MM.	FLORENCIA	25	C/U				
3397875	BOCALLAVE 130 MM.	FLORENCIA	25	C/U				
3397876	BOCALLAVE 35 MM.	FLORENCIA	25	C/U				
3397877	ARO VOLC 35 MM	ANTICHE	25	C/U				
3397878	MEDALLON 47 MM	FLORENCIA	25	C/U				
3397879	MEDALLON 37 MM	FLORENCIA	25	C/U				
3397880	MJA ARGOLLA C/ROS.	FLORENCIA	25	C/U				
3397881	MJA ARGOLLA C/ROS.	FORENCIA	25	C/U				
3397883	ARO VOLC 30 MM	ANTICHE	25	C/U				
3397885	MANIJA 64 MM.VOLCABLE	DORADO	25	C/U				
3397886	BOCALLAVE 99 MM.	DORADO	25	C/U				
3397888	MANIJA 64 MM.VOLC.	DORADO	25	C/U				
3397889	TIR.63 MM VOLC.BRONCE	DORADO	25	C/U				
3397890	ARO VOLC 25 MM ANTICHE	ANTICHE	25	C/U				
3397907	MJA FIJA ART DECO 128 MM	FLORENCIA	25	C/U				
3397908	MJA FIJA ART DECO 96 MM	FLORENCIA	25	C/U				
3397909	MJA FIJA ART DECO 64 MM	FLORENCIA	25	C/U				
3397913	TIRADOR REDONDO	ANTICHE	25	C/U				
3397914	TIRADOR REDONDO	ANTICHE	25	C/U				
3397915	TIRADOR REDONDO	FLORENCIA	25	C/U				
3397916	TIRADOR REDONDO	FLORENCIA	25	C/U				
3397917	TIRADOR REDONDO	ANTICHE	25	C/U				
3397918	TIRADOR REDONDO	ANTICHE	25	C/U				
3397919	TIRADOR LAGRIMA	ORO DI VAL	25	C/U				
3397920	PLACA EST. MODER 64 MM	FLORENCIA	25	C/U				
3397921	TIRADOR		25	C/U				
3397922	PLACA .EST.MODERN.97 MM		25	C/U				
3397923	MJA EST. LUIS XV 177 MM		25	C/U				
3397924	MJA EST. LUIS XV 131 MM		25	C/U				
3397925	PLACA ARTE POVERA 42 MM		25	C/U				
3397926	PLACA ARTE POVERA 34 MM		25	C/U				
3397927	PLACA ARTE POVERA 42 MM		25	C/U				
3397928	PLACA ARTE POVERA 34MM		25	C/U				
3397929	MJA ART DECO 96 MM ORO		25	C/U				

MANIJAS BARRAL VOLCABLES

Código	Descripción	X Caja	U.M.
2191001	MANIJA VOLCABLE 75 MM.BCEADA	24	C/U
2191002	MANIJA VOLCABLE 90 MM.BCEADA	24	C/U
2191003	MANIJA VOLCABLE 100 MM.BCEADA	24	C/U
2191004	MANIJA VOLCABLE 75 MM.NIQUEL	24	C/U
2191005	MANIJA VOLCABLE 90 MM.NIQUEL	24	C/U
2191006	MANIJA VOLCABLE 100 MM.NIQUEL	24	C/U



MANIJAS PUENTE DE BRONCE

Código	Descripción	X Caja	U.M.
PULIDO	PLATIL		
2490601	2490604 GRANDE C/FILETE	12	C/U
2490602	2490605 MEDIANA C/FILETE	12	C/U
2490603	2490606 CHICA C/FILETE	12	C/U
2126410	RECTANGULAR 100 MM CON LACA	12	C/U



MANIJAS PUENTE CHAPA

Código	Descripción	X Caja	U.M.
2080401	90 MM TIPO SOLDADORA	24	C/U
2080402	120 MM TIPO SOLDADORA	24	C/U
2080403	150 MM TIPO SOLDADORA	24	C/U
2123041	101 MM CUATRO AGUJEROS	12	C/U
2123040	127 MM CUATRO AGUJEROS	12	C/U



MANIJAS PUENTE ALUMINIO

Código	Descripción	X Caja	U.M.		
NATUR.	BLANCA	NEGRA			
2960601	2960610	2960613	CHICA	60	C/U
2960602	2960611	2960614	MEDIANA	60	C/U
2960603	2960612	2960615	GRANDE	60	C/U
2301010	CUATRO AGUJEROS			50	C/U



MANIJAS PORTAETIQUETAS

Código	Descripción	X Caja	U.M.
3010250	PORTAETIQ CON MANIJA CROMO	50	C/U
3010251	PORTAETIQ SIN MANIJA CROMO	50	C/U
2201240	TARJETERO PLASTICO TRANSPAR.	50	C/U
2201241	MANIJA CLASICA 96 MM.PLASTICO (P/TARJETERO)	50	C/U

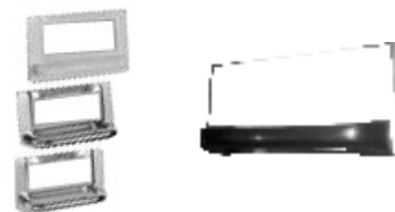

MANIJAS VOLCABLES PARA BAUL

Código	Descripción	X Caja	U.M.
2080502	40 X 96 BRONCEADA	24	C/U
2080501	40 X 96 NIQUELADA	24	C/U
2122501	BAUL CINCADEA	24	C/U
2122502	BAUL NEGRA	24	C/U



40X96

BISAGRAS MUNICION P/SOLDAR LIVIANAS

Código	Descripción	X Caja	U.M.
2410202	75X37 C/ARANDELAS	25	C/U
2410217	75X75 C/ARANDELAS	25	C/U
2410204	100X37 C/ARANDELAS	25	C/U
2410227	100X75 C/ARANDELAS	25	C/U
2410235	100X88 C/ARANDELAS	25	C/U
2410244	100x100 C/ARANDELAS	25	C/U



BISAGRAS MUNICION P/SOLDAR REFORZADAS

Código	Descripción	X Caja	U.M.
2370421	78X37 C/GRAPODINAS	30	C/U
2370423	100X37 C/GRAPODINAS	20	C/U
2370426	124X37 C/GRAPODINAS	20	C/U
2370428	145x45 C/GRAPODINAS	15	C/U
2370407	145X120 C/GRAPODINAS	10	C/U
2370408	175X130 C/GRAPODINAS	10	C/U



BISAGRA MUNICION MIXTA

Código	Descripción	X Caja	U.M.
2410205	100X75 MIXTA	25	C/U
2410206	100X88 MIXTA	25	C/U



BISAGRA TIPO MUNICION CABEZA REMACHE

Código	Descripción	X Caja	U.M.
9041301	3"X3" HIERRO BRONCEADO	12	C/U
9041302	3.5"X3.5" HIERRO BRONCEADO	12	C/U



BISAGRA MUNICION P/MADERA EN HIERRO LIVIANAS

Código	Descripción	X Caja	U.M.
2410218	75X75 CINCADO AZUL	25	C/U
24102180	75X75 CINCADO AMARILLO	25	C/U
2410228	100X75 CINCADO AZUL	25	C/U
24102280	100X75 CINCADO AMARILLO	25	C/U
2410236	100X88 CINCADO AZUL	25	C/U
24102360	100X88 CINCADO AMARILLO	25	C/U
24102170	75X75 EPOXI NEGRA	12	C/U
24102270	100X75 EPOXI NEGRA	12	C/U
24102350	100X88 EPOXI NEGRA	12	C/U



BISAGRA MUNICION P/MADERA REFORZADA

Código	Descripcion	X Caja	U.M.
2370301	78 X 78 CINCADA AZUL	24	C/U
2370302	100 X 75 CINCADA AZUL	24	C/U
2370303	100 X 88 CINCADA AZUL	24	C/U
2370304	100 X 100 CINCADA AZUL	20	C/U
2370306	124 X 100 CINCADA AZUL	20	C/U
2370307	145 X 120 CINCADA AZUL	10	C/U
2370308	175 X 130 CINCADA AZUL	10	C/U
2370350	78 X 78 BRONCEADA	24	C/U
2370351	100 X 75 BRONCEADA	24	C/U
2370352	100 X 88 BRONCEADA	24	C/U
2370353	100 X 100 BRONCEADA	20	C/U
2370354	124 X 100 BRONCEADA	20	C/U
2370355	145 X 120 BRONCEADA	10	C/U
2370356	175 X 130 BRONCEADA	10	C/U



BISAGRAS A MUNICION DOBLE CONTACTO

Código	Descripción	X Caja	U.M.
2370501	100X80 REFORZADA CINC.AZUL	20	C/U
2371502	124X80 REFORZADA CINC.AZUL	20	C/U
2410250	100X80 LIVIANA CINCADA AZUL	25	C/U
2410251	100X80 LIVIANA CINCADA DORADO	25	C/U



BISAGRA A MUNICION PARA MADERA BRONCE REFORZADAS

Código	Descripcion	X Caja	U.M.
PULIDO	PLATIL		
2410221	2410222 75 X 75	12	C/U
2410231	2410232 100 X 75	12	C/U
2410239	2410240 100 X 88	12	C/U
2371004	2371023 100 X 100	12	C/U
2371005	2371024 124 X 100	12	C/U



BISAGRA A MUNICION PARA MADERA BRONCE LIVIANAS

Código	Descripción	X Caja	U.M.
2127081	75x75	1	PAR
2127082	100x75	1	PAR
2127083	100x88	1	PAR
2127084	100x100	1	PAR
2127085	125x100	1	PAR

OBS.: En bronce pulido y laqueado. Ind. China

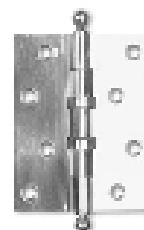

BISAGRAS TIPO MUNICION ACERO INOXIDABLE

Código	Descripción	X Caja	U.M.
9043030	75 X 75 CON AGUJEROS	5	PAR
9043031	89 X 89 CON AGUJEROS	5	PAR
9043032	100 X 100 CON AGUJEROS	5	PAR

OBS.: Incluye tornillos en acero inoxidable

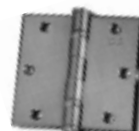

BECLISA

POMELAS DE HIERRO TIPO 110

Código		Descripción	X Caja	U.M.
DER	IZQ			
2371501	23715010	90X65 COMUN	40	C/U
2371510	23715100	90X67 D/CONTACTO	40	C/U

OBS.: Ternimacion cincado amarillo.



Mano der

POMELAS DE HIERRO STANDARD

Código		Descripción	X Caja	U.M.
DER	IZQ			
2410309	24103091	110 CINCADA AZUL	25	C/U
24103090	24103092	110 CINCADA AMARILLA	25	C/U
2410321	24103211	140 CINCADO AZUL	25	C/U
24103210	24103212	140 CINCADO AMARILLA	25	C/U
2410336	24103361	160 CINCADO AZUL	25	C/U
24103360	24103362	160 CINCADO AMARILLA	25	C/U



IZQ

POMELAS DE HIERRO DOBLES CONTACTO

Código		Descripción	X Caja	U.M.
DER	IZQ			
2410361	24103611	110 CINCADO AZUL	25	C/U
24103610	24103612	110 CINCADO AMARILLO	25	C/U
2410366	24103661	140 CINCADO AZUL	25	C/U
24103660	24103662	140 CINCADO AMARILLO	25	C/U
2120905	2120906	160 CINCADO AZUL	12	C/U
2121005	2121006	160 CINCADO AMARILLO	12	C/U

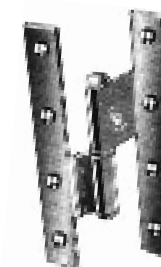

POMELAS DE HIERRO MIXTAS

Código		Descripción	X Caja	U.M.
DER	IZQ			
2410350	24103500	110 MIXTA	25	C/U
2410351	24103510	140 MIXTA	25	C/U
2410353	24103530	160 MIXTA	25	C/U

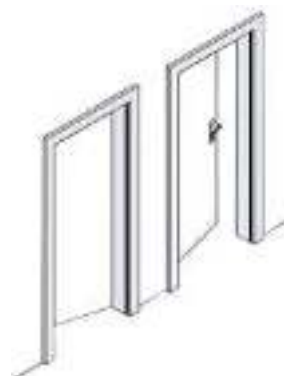

Mano derecha

Mano izquierda

POMELAS DE BRONCE STANDARD

Código		Descripción	X Caja	U.M.
DER	IZQ			
2303001	23030010	35X35 PULIDO	12	C/U
23030011	23030012	35X35 PLATIL	12	C/U
2303002	23030020	45X45 PULIDO	12	C/U
23030021	23030022	45X45 PLATIL	12	C/U
2303003	23030030	55X55 PULIDO	12	C/U
23030031	23030032	55X55 PLATIL	12	C/U
3851001	38510010	80X55 PULIDO	12	C/U
38510011	38510012	80X55 PLATIL	12	C/U
3851002	38510020	110X60 PULIDO	12	C/U
38510021	38510022	110X60 PLATIL	12	C/U
3851003	38510030	140X70 PULIDO	12	C/U
38510031	385100312	140X70 PLATIL	12	C/U
3851004	38510040	160X80 PULIDO	12	C/U
38510041	38510042	160X80 PLATIL	12	C/U



Mano der

POMELAS DE BRONCE DOBLE CONTACTO

Código		Descripción	X Caja	U.M.
DER	IZQ			
3851020	38510200	110X60 PULIDO	12	C/U
38510201	38510202	110X60 PLATIL	12	C/U
3851021	38510210	140X70 PULIDO	12	C/U
38510211	38510212	140X70 PLATIL	12	C/U
3851022	38510220	160X80 PULIDO	12	C/U
38510221	38510222	160X80 PLATIL	12	C/U



POMELAS DE BRONCE MIXTAS

Código		Descripción	X Caja	U.M.
DER	IZQ			
3851015	38510150	110X60 BRONCE	12	C/U
38510151	38510152	110X60 PLATIL	12	C/U
3851016	38510160	140X70 BRONCE	12	C/U
38510610	38510620	140X70 PLATIL	12	C/U
3851017	38510170	160X80 BRONCE	12	C/U
38510171	38510172	160X80 PLATIL	12	C/U



POMELAS DE BRONCE CON PERILLA

Código		Descripción	X Caja	U.M.
DER	IZQ			
3851050	38510500	80X55 PULIDO	12	C/U
38510501	38510502	80X55 PLATIL	12	C/U
3851051	38510510	110X60 PULIDO	12	C/U
38510511	38510512	110X60 PLATIL	12	C/U
3851052	38510520	140X70 PULIDO	12	C/U
38510521	38510522	140X70 PLATIL	12	C/U
3851053	38510530	160X80 PULIDO	12	C/U
38510531	38510532	160X80 PLATIL	12	C/U





BISAGRA FICHA CARPINTERO HIERRO

Código	Descripción	X Caja	U.M.
2410119	80X20 CINCADA AZUL	25	C/U
2410190	80X20 CINCADA AMARILLO	25	C/U
2410122	2X3X1.5 CINCADA AZUL	25	C/U
24101220	2X3X1.5 CINCADA AMARILLO	25	C/U
2410131	2X5X1.5 CINCADA AZUL	25	C/U
24101310	2X5X1.5 CINCADA AMARILLO	25	C/U
2410125	2 X 3 X 2 CINCADO AZUL	25	C/U
24101250	2 X 3 X 2 CINCADO AMARILLO	25	C/U
2410126	2 X 3 X 2 DORADO	25	C/U
2410127	2 X 3 X 2 DORADO CON PERILLA	25	C/U
2410134	2 X 5 X 2 CINCADA AZUL	25	C/U
24101340	2 X 5 X 2 CINCADO AMARILLO	25	C/U
2410135	2 X 5 X 2 DORADO	25	C/U
2410136	2 X 5 X 2 DORADO CON PERILLA	25	C/U



Mano izq.

BISAGRA FICHA CARPINTERO BRONCE ESTAMPADO

Código	Descripción	X Caja	U.M.
PULIDO	PLATIL		
2410128	24101280 2X3X2	12	C/U
2410137	24101370 2X5X2	12	C/U
2410129	2410130 2X3X2 CON PERILLA	12	C/U
2410137	24101370 2X5X2 CON PERILLA	12	C/U



BISAGRAS FICHA PARA ALUMINIO

Código	Descripción	X Caja	U.M.
2410703	CONJUNTO 84 BLANCO	12	C/U
2410702	CONJUNTO 84 NEGRO	12	C/U
2410706	CONJUNTO 6 BLANCO	12	C/U
2410705	CONJUNTO 6 NEGRO	12	C/U
2410709	CONJUNTO 56 BLANCO	12	C/U
2410708	CONJUNTO 56 NEGRO	12	C/U
2410712	CONJUNTO 52 BLANCO	12	C/U
2410711	CONJUNTO 52 NEGRO	12	C/U
2410715	CONJUNTO H33 CUADRADO BLANCO	12	C/U
2410714	CONJUNTO H33 CUADRADO NEGRO	12	C/U
2410718	CONJUNTO H330 CUADR.BLANCO	12	C/U
2410717	CONJUNTO H330 CUADR.NEGRO	12	C/U
2410721	CONJUNTO R5 BLANCO	12	C/U
2410720	CONJUNTO R5 NEGRO	12	C/U
2410724	CONJUNTO H66 BLANCO	12	C/U
2410723	CONJUNTO H66 NEGRO	12	C/U
2410727	CONJUNTO H33 REDONDO BLANCO	12	C/U
2410726	CONJUNTO H33 REDONDO NEGRO	12	C/U
2410730	CONJUNTO H 330 RED.BLANCO	12	C/U
2410729	CONJUNTO H 330 RED.NEGRO	12	C/U

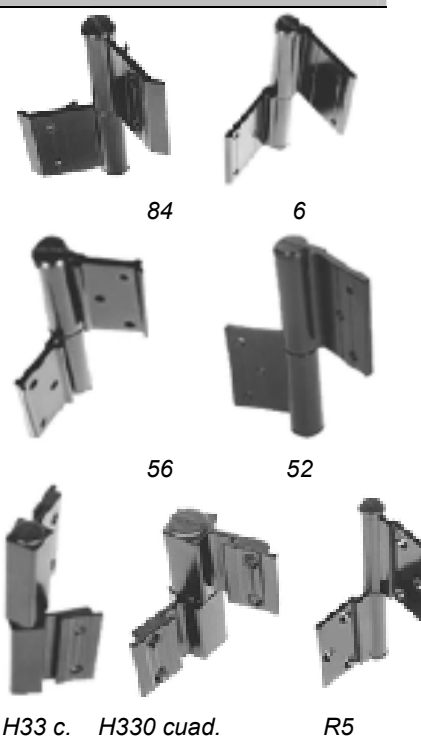

2410733	CONJUNTO FL-H1 BLANCO	12	C/U
2410732	CONJUNTO FL-H1 NEGRO	12	C/U
2410736	CONJUNTO FL-H2 BLANCO	12	C/U
2410735	CONJUNTO FL-H2 NEGRO	12	C/U
2410743	CONJUNTO H61 BLANCO	12	C/U
2410742	CONJUNTO H61 NEGRO	12	C/U
2410745	CONJUNTO H62 BLANCO	12	C/U
2410744	CONJUNTO H62 NEGRO	12	C/U

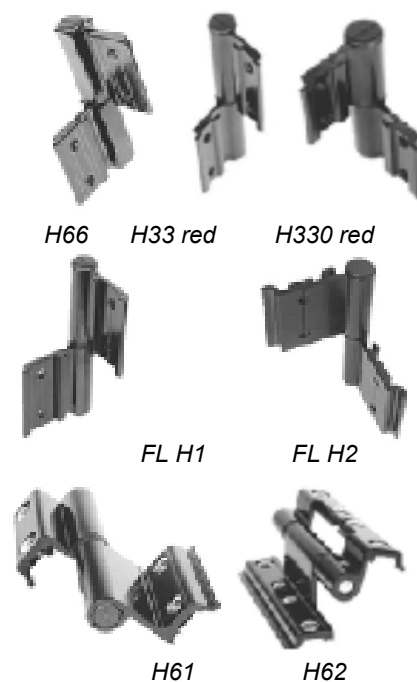

BISAGRA FICHA HERRERO REVERSIBLE

Código	Descripción	X Caja	U.M.
2410103	60X08X1.5 DOS ALAS CORTAS	25	C/U
2410101	60X22X1.5 DOS ALAS LARGAS	25	C/U
2410104	80X22X1.5 DOS ALAS LARGAS	25	C/U
2410109	60X8 DOS ALAS CORTAS	25	C/U
2410112	80X8 DOS ALAS CORTAS	25	C/U
2410115	100X8 DOS ALAS CORTAS	25	C/U
2410111	60X33 DOS ALAS LARGAS	25	C/U
2410114	80X33 DOS ALAS LARGAS	25	C/U
2410117	100X33 DOS ALAS LARGAS	25	C/U
2410118	120X33 DOS ALAS LARGAS	25	C/U
2410110	60X33X8 UNA CORTA UNA LARGA.	25	C/U
2410113	80X33X8 UNA CORTA UNA LARGA	25	C/U
2410116	100X33X8 UNA CORTA UNA LARGA.	25	C/U



BISAGRAS PARA HERRERO

Código	Descripción	X Caja	U.M.
2700603	DOS ALAS P/SOLDAR	25	C/U
2700604	MIXTA (PARA SOLDAR Y AMURAR)	25	C/U



BISAGRAS TORNEADAS

Código	Descripción	X Caja	U.M.
2170501	15X70	25	C/U
2170502	20X50	25	C/U
2170503	20X80	25	C/U
2170504	22X65	25	C/U
2170506	25X60	25	C/U
2170507	25X80	25	C/U
2170508	25X100	25	C/U
2170509	32X80	25	C/U
2170510	32X100	25	C/U



2170511	32X125	25	C/U
2170512	38X100	25	C/U
2170513	38X125	25	C/U
3010220	PARA TAPACINTA	100	C/U

PIVOT DE PISO

Código	Descripción	X Caja	U.M.
PARA PUERTAS			
1190205	300 GIRATORIO ALUMINIO	1	C/U
11902050	300 GIRATORIO BRONCE	1	C/U
1190207	310 DE EMPOTRAR TAPA ACERO	1	C/U
11902070	310 DE EMPOTRAR TAPA BRONCE	1	C/U
1190206	320 DE APLICAR	1	C/U
PARA BANDEROLAS			
1190208	330 (2 REGULABLES) DE ALUMINIO	1	C/U
11902080	330 (2 REGULABLES) DE BRONCE	1	C/U

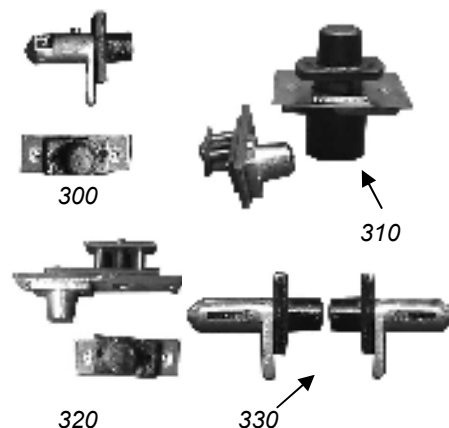

BISAGRAS FORJADAS

Código	Descripción	X Caja	U.M.
2700201	ATORNILLAR 13 CM.	1	C/U
2700202	ATORNILLAR 20 CM.	1	C/U
2700203	ATORNILLAR 25 CM.	1	C/U
2700204	ATORNILLAR 30 CM.	1	C/U
2700205	ATORNILLAR 40 CM.	1	C/U
2700206	ATORNILLAR 50 CM.	1	C/U
2700101	AMURAR 13 CM.	1	C/U
2700102	AMURAR 20 CM.	1	C/U
2700103	AMURAR 25 CM.	1	C/U
2700104	AMURAR 30 CM.	1	C/U
2700105	AMURAR 40 CM.	1	C/U
2700106	AMURAR 50 CM.	1	C/U

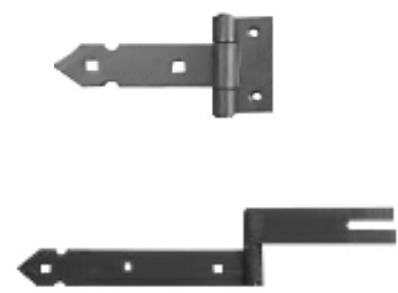

BISAGRAS PARA ATORNILLAR DOBLES

Código	Descripción	X Caja	U.M.
2700401	38 MM	1	C/U
2700402	70 MM	1	C/U
2700403	75 MM	1	C/U
2700301	130 CM (COMBINA CON 13,20 Y 25)	1	C/U
2700302	170 CM (COMBINA CON 30 CM.)	1	C/U

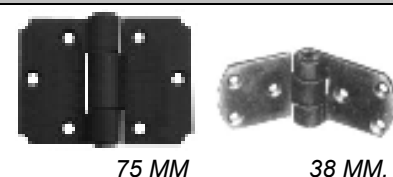

BISAGRA DOBLE ACCION

Código	Descripción	X Caja	U.M.
HIERRO PARA PUERTAS DE 1.5"			
3200200	50 MM H'NEGRO	2	PAR
3200229	63 MM H'NEGRO	2	PAR
3200201	76 MM H'NEGRO	2	PAR
3200202	101 MM H'NEGRO	2	PAR
3200203	127 MM H'NEGRO	1	PAR
3200204	150 MM H'NEGRO	1	PAR
3200220	76 MM H'PLATIL	2	PAR



3200221	101 MM H' PLATIL	2	PAR
3200222	127 MM H'PLATIL	1	PAR
3200223	150 MM H'PLATIL	1	PAR

HIERRO PARA PUERTAS DE 2"

3200206	76-50 MM CHAROL	2	PAR
3200208	101-50 MM CHAROL	2	PAR
3200225	76-50 MM H'PLATIL.	2	PAR
3200227	101-50MM H'PLATIL	2	PAR

OBS.: PARA PUERTAS DE DOS PULGADAS

BRONCE PARA PUERTAS DE 1.5"

3200301	76 MM BCE	2	PAR
3200302	101 MM BCE	2	PAR
3200303	127 MM BCE	1	PAR
3200304	150 MM BCE	1	PAR

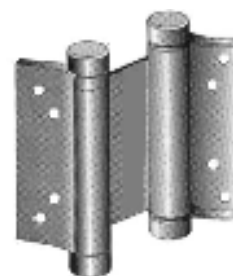

BISAGRA SIMPLE ACCION

Código	Descripción	X Caja	U.M.
3200230	BIS S/A 76 MM H'NEGRO	2	PAR
3200231	BIS S/A 101 MM H'NEGRO	2	PAR
3200232	BIS S/A 127 MM H'NEGRO	2	PAR
3200235	BIS S/A 76 MM H'PLATIL	2	PAR
3200236	BIS S/A 101 MM H'PLATIL	2	PAR
3200237	BIS S/A 127 MM H'PLATIL	2	PAR

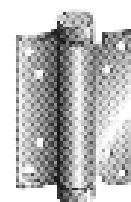

BISAGRAS DOBLE ACCIÓN LIVIANAS

Código	Descripción	X Caja	U.M.
2127060	3" CHAROLADA	2	C/U
2127061	4" CHAROLADA	2	C/U
2127062	5" CHAROLADA	2	C/U

OBS: Industria china



BISAGRAS VAIVEN ALUMINIO

Código	Descripción	X Caja	U.M.
9043090	SIMPLE ACCION ANODIZ.NATURAL	2	C/U
9043091	DOBLE ACCION ANODIZ. NATURAL	2	C/U

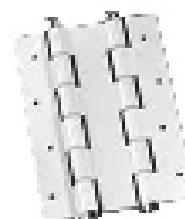

BISAGRAS " FAR WEST "

Código	Descripción	X Caja	U.M.
2330101	" BAIBEN 2000" TRADICIONAL	1	JUEGO
2330105	" BAIBEN 2000" REFORZADO	1	JUEGO

OBS.: PARA PUERTAS DE HASTA 12Kg Y 30 KG RESP.

EL JUEGO CONTIENE LO NECESARIO PARA DOS HOJAS

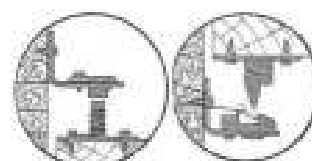

BISAGRAS TIPO CARROCERA

Código	Descripción	X Caja	U.M.
2370201	65X67 CON AGUJERO CINCADA AZUL	60	C/U
2370204	65X67 SIN AGUJERO HIERRO.	60	C/U



BISAGRAS PARA PUERTA MOSQUITERA

Código	Descripción	X Caja	U.M.
2127070	BISAGRA MOSQUERA CHAROL	10	C/U
3202011	BISAGRA MOSQUERA CINCADA	24	C/U

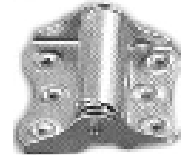

BISAGRAS TIPO 1842

Código	Descripción	X Caja	U.M.
2440101	25 mm HIERRO	48	C/U
2440102	32 mm HIERRO	48	C/U
2440103	38 mm HIERRO	48	C/U
2440104	51 mm HIERRO	24	C/U
2440105	63 mm HIERRO	24	C/U
2441101	25 mm HIERRO CINC.AMARILLO	48	C/U
2441102	32 mm HIERRO CINC.AMARILLO	48	C/U
2441103	38 mm HIERRO CINC.AMARILLO	48	C/U
2441104	51 mm HIERRO CINC.AMARILLO	24	C/U
2441105	63 mm HIERRO CINC.AMARILLO	24	C/U
3530402	51 MM ACERO INOX PULIDO	44	C/U
3530412	51 MM BRONCE PULIDO	44	C/U
3530413	51 MM BRONCE PLATIL	44	C/U
3530411	51 MM BRONCEADA	44	C/U



BISAGRAS TIPO ESCALERA

Código	Descripción	X Caja	U.M.
2440201	19x75 HIERRO	24	C/U
2440202	25x100 HIERRO	24	C/U
2440203	25x150 HIERRO	24	C/U
2441201	19x75 HIERRO CINC.AMARILLO	24	C/U
2441202	25x100 HIERRO CINC.AMARILLO	24	C/U
2441203	25x150 HIERRO CINC.AMARILLO	24	C/U



BISAGRAS "T"

Código	Descripción	X Caja	U.M.
2127020	BISAGRA T - 3" HIERRO	24	C/U
2127021	BISAGRA T - 4" HIERRO	24	C/U
2127022	BISAGRA T - 5" HIERRO	12	C/U
2127023	BISAGRA T - 6" HIERRO	12	C/U
2127024	BISAGRA T - 8" HIERRO	12	C/U
2127025	BISAGRA T - 10" HIERRO	12	C/U



BISAGRAS EXTRA REFORZADAS

Código	Descripción	X Caja	U.M.
2440301	50x110 HIERRO	24	C/U
2440302	60x150 HIERRO	24	C/U
2440303	75x140 HIERRO	24	C/U
2441301	50x110 CINCADA AMARILLA	24	C/U
2441302	60x150 CINCADA AMARILLA	24	C/U
2441303	75x140 CINCADA AMARILLA	24	C/U



BISAGRAS TIPO ITALIANA COMUNES

Código	Descripción	X Caja	U.M.
2110123	60-7 BRONCEADA	100	C/U
2110130	60-7 FLORENTINO	100	C/U
2110116	60-7 NIQUELADA	100	C/U
2110124	60-9 BRONCEADA	50	C/U
2110131	60-9 FLORENTINO	50	C/U
2110117	60-9 NIQUELADA	50	C/U
2110125	60-11 BRONCEADA	50	C/U
2110132	60-11 FLORENTINO	50	C/U
2110118	60-11 NIQUELADA	50	C/U
2110126	60-13 BRONCEADA	50	C/U
2110133	60-13 FLORENTINO	50	C/U
2110119	60-13 NIQUELADA	50	C/U
2110127	60-14 BRONCEADA	25	C/U
2110134	60-14 FLORENTINO	25	C/U
2110120	60-14 NIQUELADA	25	C/U
2110128	60-16 BRONCEADA	25	C/U
2110135	60-16 FLORENTINO	25	C/U
2110121	60-16 NIQUELADA	25	C/U

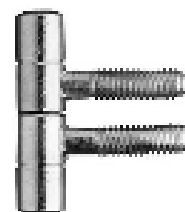
**DIAMETRO DE MECHA A UTILIZAR**

BIS.N°7	3.50 MM.
BIS.N°9	5.00 MM.
BIS.N°11	5.75 MM.
BIS.N°13	7.00 MM.
BIS.N°14	7.25 MM.
BIS.N°16	7.50 MM.

BISAGRAS TIPO ITALIANA DE ESTILO

Código	Descripción	X Caja	U.M.
2110222	61-7 BRONCEADA	100	C/U
2110229	61-7 FLORENTINO	100	C/U
2110215	61-7 NIQUELADA	100	C/U
2110223	61-9 BRONCEADA	50	C/U
2110230	61-9 FLORENTINO	50	C/U
2110216	61-9 NIQUELADA	50	C/U
2110225	61-11 BRONCEADA	50	C/U
2110232	61-11 FLORENTINO	50	C/U
2110218	61-11 NIQUELADA	50	C/U
2110226	61-13 BRONCEADA	50	C/U
2110233	61-13 FLORENTINO	50	C/U
2110219	61-13 NIQUELADA	50	C/U
2110227	61-14 BCEADA	25	C/U
2110234	61-14 FLORENTINO	25	C/U
2110220	61-14 NIQUELADA	25	C/U
2110228	61-16 BRONCEADA	25	C/U
2110235	61-16 FLORENTINO	25	C/U
2110221	61-16 NIQUELADA	25	C/U

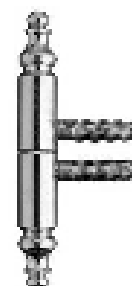

Plantilla para
colocar bisagras
en pag.239

BISAGRAS PARA MARCO METALICO

Código	Descripción	X Caja	U.M.
2110504	64-11 MIXTA	50	C/U
2110510	64-11 P/SOLDAR	50	C/U
2110505	64-13 MIXTA	50	C/U
2110511	64-13 P/SOLDAR	50	C/U
2110506	64-14 MIXTA	25	C/U



MHA

BISAGRAS PIANO

Código	Descripción	X Caja	U.M.
9043500	3.50 MT. BRONCEADA	1	C/U
9043499	3.50 MT. NIQUELADA	1	C/U
3570101	3.50 MT. BRONCE PULIDO	1	C/U
23533455	3.50 MT. ACERO INOXIDABLE	1	C/U

MEDIDAS ESPECIALES

2280101	BIS PIANO HIERRO 2000X30X2X0.7	1	C/U
2280102	BIS PIANO HIERRO 2000X40X3X1.5	1	C/U
2280103	BIS PIANO HIERRO 2000X50X3X1.5	1	C/U
2280104	BIS PIANO HIERRO 2000X60X3X1.5	1	C/U
2280105	BIS PIANO HIERRO 2000X70X3X1.5	1	C/U
2280106	BIS PIANO HIERRO 2000X50X5X1.5	1	C/U
2280109	BIS PIANO HIERRO 2000X60X5X1.5	1	C/U
2280112	BIS PIANO HIERRO 2000X70X5X1.5	1	C/U
2280114	BIS PIANO HIERRO 2200X70X5X1.5	1	C/U
2280115	BIS PIANO HIERRO 2000x60x8x1.5	1	C/U
2280118	BIS PIANO HIERRO 2000x70x8x1.5	1	C/U
2280121	BIS PIANO HIERRO 2000x70x6x2	1	C/U
2280124	BIS PIANO HIERRO 2000x70x6x2	1	C/U
2280127	BIS PIANO HIERRO 2000x80x6x2	1	C/U
2280128	BIS PIANO HIERRO 2000x100x6x2	1	C/U
2280129	BIS PIANO HIERRO 2000x90x8x1.5	1	C/U

OBS. MEDIDAS: LARGO X ANCHO X DIAM. EJE X ESPESOR
EN CHAPA D.D. - INDICAR CON O SIN AGUJEROS

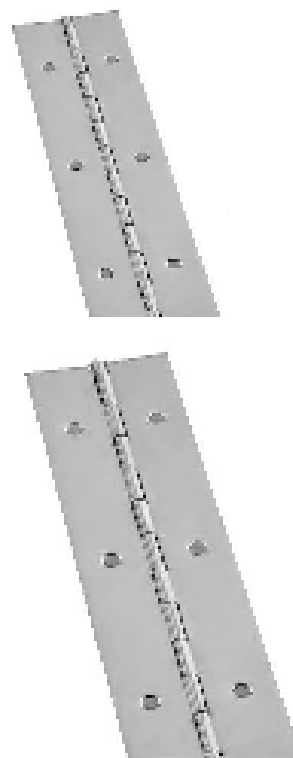

BISAGRAS PARA ESTUCHES

Código	Descripción	X Caja	U.M.
3480110	BISAGRA PARA CLAVAR CHICA	100	C/U
3481011	BISAGRA PARA CLAVAR GRANDE	100	C/U
3530450	BISAGRA CON TOPE DE APERTURA	12	C/U



BISAGRAS LIBRO HIERRO

Código	Descripción	X Caja	U.M.
HIERRO BRONCEADO			
3530101	3530111 19 MM	1	CIEN
3530102	3530112 25 MM	2	D.P
2100103	2100203 32 MM	1	D.P
3530105	3530113 38 MM	1	D.P
3530106	3530119 51 MM	1	D.P
3530107	3530120 63 MM	1	D.P
3530108	3530121 76 MM	1	D.P
3530109	35301211 89 MM	1	D.P
3530110	3530122 101 MM	1	D.P
3530003	38 MM HIERRO NIQUELADO	1	CIEN
3530004	51 MM HIERRO NIQUELADO	1	CIEN
3530005	63 MM HIERRO NIQUELADO	1	CIEN
3530006	76 MM HIERRO NIQUELADO	1	CIEN

OBS: D.P= Docena de par. La cantidad x caja es según la unidad de medida.

B
GN

BISAGRA LIBRO HIERRO

CHINA

Código	Med.	Descrip.	Código	Descrip.	X Caja	U.M.
2127001	19 MM	HIERRO	2127009	BCEADA	5	D.P
2127002	25 MM	HIERRO	2127010	BCEADA	2	D.P
2127003	38 MM	HIERRO	2127011	BCEADA	1	D.P
2127004	51 MM	HIERRO	2127012	BCEADA	1	D.P
2127005	63 MM	HIERRO	2127013	BCEADA	1	D.P
2127006	76 MM	HIERRO	2127014	BCEADA	1	D.P
2127007	89 MM	HIERRO	2127015	BCEADA	1	D.P
2127008	101 MM	HIERRO	2127016	BCEADA	1	D.P



BISAGRA LIBRO BRONCE

Código	Med.	Descrip.	Código	Descrip.	X Caja	U.M.
3530124	25 MM.	PULIDO	3531300	PLATIL	2	D.P
2100302	32 MM.	PULIDO	2100402	PLATIL	1	D.P
3530125	38 MM.	PULIDO	3530131	PLATIL	1	D.P
3530126	51 MM.	PULIDO.	3530132	PLATIL	1	D.P
3530127	63 MM.	PULIDO.	3530133	PLATIL	1	D.P
3530128	76 MM.	PULIDO	3530134	PLATIL	1	D.P



BISAGRA LIBRO ACERO INOXIDABLE

Código	Descripción	X Caja	U.M.
3530234	38 MM PULIDA	1	D.P
3530235	51 MM PULIDA	1	D.P
3530236	63 MM PULIDA	1	D.P
3530237	76 MM PULIDA	1	D.P



BISAGRA LIBRO C/PERILLA

Código	Descripción	X Caja	U.M.			
HIERRO BRONCEADO						
3530140	38 MM. BCEADA DESARMABLE	1	D.P			
3530141	51 MM. BCEADA DESARMABLE	1	D.P			
3530142	63 MM. BCEADA DESARMABLE	1	D.P			
3530143	76 MM. BCEADA DESARMABLE	1	D.P			
BRONCE						
Código	Med.	Descrip.	Código	Descrip.	X Caja	U.M.
3530150	38 MM	PULIDO	3530160	PLATIL	1	D.P
3530151	51 MM	PULIDO	3530161	PLATIL	1	D.P
3530152	63 MM	PULIDO	3530162	PLATIL	1	D.P
3530153	76 MM	PULIDO	3530163	PLATIL	1	D.P



BISAGRA LIBRO C/PERILLA DE ESTILO

Código	Descripción	X Caja	U.M.
9043020	50 MM BRONCE LAQUEADA	20	C/U
9043021	60 MM BRONCE LAQUEADA	20	C/U
9043022	70 MM BRONCE LAQUEADA	20	C/U





BISAGRAS FICHA MUEBLE HIERRO

Código		Descripción	X Caja	U.M.
DER	IZQ			
3530350	35303500	50 MM NIQUEL	40	C/U
3530351	35303510	63 MM NIQUEL	40	C/U
3530352	35303520	50 MM BCEADA	40	C/U
3530353	35303530	63 MM BCEADA	40	C/U
3530354	35303540	50 MM BRONCE	40	C/U
3530355	35303550	63 MM BRONCE	40	C/U
3530356	35303560	50 MM BCE PLATIL	40	C/U
3530357	35303570	63 MM BCE PLATIL	40	C/U



IZQ.

BISAGRAS MACIZAS "BB"

Código	Descripción	X Caja	U.M.
3042701	MACIZA METÁLICA CROMO	100	C/U
3120201	MACIZA PLÁSTICA MARRON	100	C/U
3120203	MACIZA PLÁSTICA NEGRA	100	C/U
3120202	MACIZA PLÁSTICA BLANCA	100	C/U



BISAGRAS PESTAÑA PARA MUEBLE

Código	Descripción	X Caja	U.M.
2101701	N'1 CINCADEA	40	C/U
2101702	N'2 CINCADEA	40	C/U
2101705	N'2 BRONCEADA	40	C/U
3530301	N'3 CINCADEA	40	C/U
3530302	N'3 BRONCEADA	40	C/U
3530303	N'3 BCE.PULIDO	40	C/U
3530304	N'3 BCE.PLATIL	40	C/U
3530311	N'3 ACERO INOXIDABLE	40	C/U
3530305	N'4 CINCADEA	40	C/U
3530306	N'4 BRONCEADA	40	C/U
3530307	N'4 BCE.PULIDO	40	C/U
3530308	N'4 BCE.PLATIL	40	C/U
3530313	N'4 ACERO INOXIDABLE	40	C/U
3530320	N'5 CINCADEA AMARILLO (N.4 CHICA)	100	C/U



Num. 1



Num 2

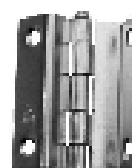

Num 3

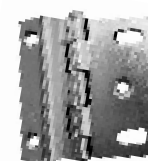

Num. 4



Num 5

BISAGRAS PARA MESA TRAMPA

Código	Descripción	X Caja	U.M.
2101803	CUADRADA 48MM. BRONCEADA.	24	C/U
9043101	CILINDRICA 12 MM BRONCE	24	C/U
9043102	CILINDRICA 14 MM BRONCE	24	C/U



PIVOT BRONCE FUNDIDO

Código	Descripción	X Caja	U.M.
2490901	C/ CODO 35 MM. FUNDIDO.	10	PAR
2490902	C/ CODO 50 MM. FUNDIDO.	10	PAR
2490903	C/ CODO 60 MM. FUNDIDO.	10	PAR
2490904	C/ CODO 70 MM. FUNDIDO.	10	PAR
2490905	RECTO 50 MM. FUNDIDO.	10	PAR
2490906	RECTO 60 MM. FUNDIDO.	10	PAR
2490907	RECTO 70 MM. FUNDIDO.	10	PAR
2490908	RECTO 80 MM. FUNDIDO.	10	PAR

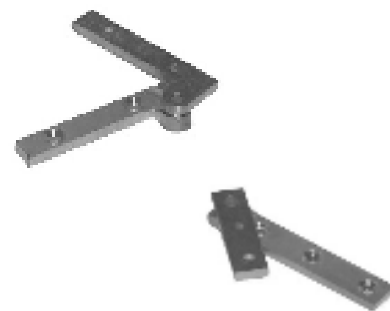

PIVOT PARA EMBUTIR BRONCEADO

Código		Descripción	X Caja	U.M.
DER	IZQ			
2100803	2100804	CON CODO 50 MM.	20	C/U
2100805	2100806	CON CODO 60 MM.	20	C/U
2101102	2101103	DE CENTRO 60 MM.	20	C/U



Con codo

De centro

PIVOT PARA PUERTA DE APLICAR

Código	Descripción	X Caja	U.M.
2101203	19 MM. SIMPLE BRONCEADO DER	10	C/U
2101204	19 MM. SIMPLE BRONCEADO IZQ	10	C/U
2101201	19 MM. SIMPLE CINCADO DER	10	C/U
2101202	19 MM. SIMPLE CINCADO IZQ	10	C/U
2101402	19 MM. DOBLE ACCION BRONCEADO	10	C/U
2101401	19 MM. DOBLE ACCION CINCADO	10	C/U



PIVOT PARA BOTIQUIN NIQUELADO

Código	Descripción	X Caja	U.M.
3043600	SIMPLE ACCION DERECHO	24	C/U
3043601	SIMPLE ACCION IZQUIERDO	24	C/U
3043602	DOBLE ACCION	24	C/U



PIVOT INVISIBLE

Código	Descripción	X Caja	U.M.
3080702	PLASTICO MARRON	50	PAR
2201550	TIPO "L" PLASTICO	50	C/U

OBS.: EL PAR SE COMPONE POR UN PIVOT FIJO Y UNO CON RESORTE (PLASTICO)



Un par

PIVOT PARA PUERTA DE VIDRIO

Código	Descripción	X Caja	U.M.
2360501	NEGRO	2	PAR
23605010	NIQUELADO	2	PAR
23605011	BRONCEADO	2	PAR

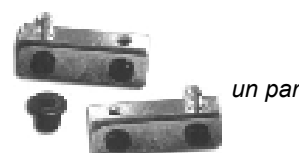

un par

MANIJAS PARA VIDRIO

Código	Descripción	X Caja	U.M.
2360503	CON PESTAÑA NEGRA	50	C/U
23605030	CON PESTAÑA NIQUELADA	50	C/U
23605031	CON PESTAÑA DORADA	50	C/U
2360502	SIN PESTAÑA NEGRA	50	C/U
23605020	SIN PESTAÑA NIQUELADA	50	C/U
23605021	SIN PESTAÑA DORADA	50	C/U

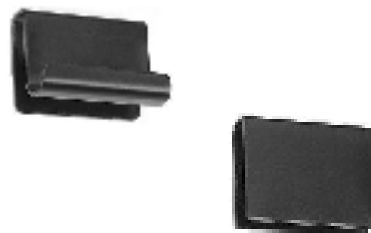

BISAGRA PARA VIDRIO CON RETEN

Código	Descripción	X Caja	U.M.
2353351	ANGULAR NIQUEL (vertice de la puerta)	25	PAR
2353352	CENTRAL NIQUEL (centro de la puerta)	25	PAR
2353353	ANGULAR DORADA	25	PAR
2353354	CENTRAL DORADA	25	PAR
2353290	TIRADOR NIQUEL	25	PAR
2353291	TIRADOR DORADO	25	PAR

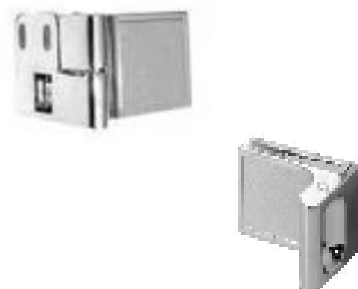

BISAGRAS PARA MUEBLE A RESORTE

Código	Descripción	X Caja	U.M.
3042503	N° 2 BF	150	C/U
3042504	N° 3 C/CORREDERA	150	C/U
3042509	N°5 CON BASE CRUZ	150	C/U
3042508	N°5 SIN BASE	150	C/U
3042510	N°6 CF-CORTA	150	C/U
3042511	N°6 LF-LARGA	150	C/U
3042601	TAPA METALICA CINCADA	100	C/U
3042603	TAPA PLASTICA BLANCA	100	C/U
3042604	BASE CRUZ SOLA P/BIS. N:5	100	C/U

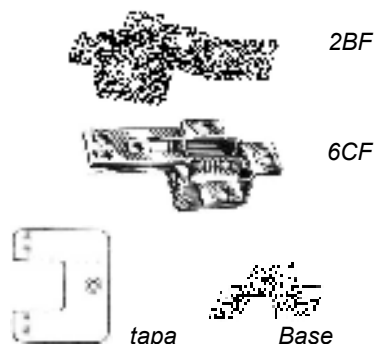

BISAGRAS PARA MUEBLE 90° Y 180°

Código	Descripción	X Caja	U.M.
2200310	B-12 90° BRONCEADA	50	C/U
2200301	B-12 90° CINCADA	50	C/U
2200311	B-13 180° BRONCEADA	50	C/U
2200303	B-13 180° CINCADA	50	C/U

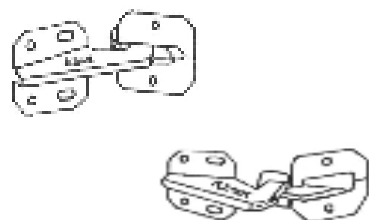

BISAGRAS ARTICULADAS

Código	Descripción	X Caja	U.M.
2101901	"B.H." CINCADA	30	C/U
3042501	"ALPINA" CINCADA	20	C/U
9043001	"M.H.A" NIQUELADA CON TORNILLOS	20	C/U





BISAGRAS PARA MUEBLE DE COCINA

Código	Descripción	X Caja	U.M.
BISAGRAS CAZOLETA 26 MM			
9122015	SERIE IC CODO 0	400	C/U
9122016	SERIE IC CODO 10	400	C/U
9122017	SERIE IC CODO 17	400	C/U
9121025	SERIE SLIDE ON 95 CODO 0	400	C/U
9121026	SERIE SLIDE ON 95 CODO 9	400	C/U
9121027	SERIE SLIDE ON 95 CODO 17	400	C/U
BISAGRAS CAZOLETA 35 MM			
COMUN BASE CLIP			
9122001	- IC CODO 0	200	C/U
9122002	- IC CODO 9	200	C/U
9122003	- IC CODO 17	200	C/U
9122008	- IC CODO 0 C/TARUGOS	200	C/U
9121001	9121005 SLIDE ON 95 CODO 0	200	C/U
9121002	9120010 SLIDE ON 95 CODO 10	200	C/U
9121003	9120011 SLIDE ON 95 CODO 17	200	C/U
BISAGRAS CAZOL.35 MM ESQUINERAS			
COMUN BASE CLIP			
9121010	9120015 170°-35 ESQUIN	200	C/U
9121015	9120016 60°-35 RINCON	200	C/U
BISAGRAS CAZOL.35 MM ANGULARES			
COMUN BASE CLIP			
9121018	9120020 ANGULAR +45°	200	C/U
9121020	9120021 ANGULAR -45°	200	C/U
BISAGRAS CON AMORTIGUADOR			
9122020	BASE CLIP 35 MM CODO 0	200	C/U
9122021	BASE CLIP 35 MM CODO 10	200	C/U
9122022	BASE CLIP 35 MM CODO 17	200	C/U
BISAGRA P/BATIENTE ANGOSTO			
9121035	CODO 0	200	C/U
9121034	CODO 0 BASE ALTA (EQUIVALE COD017)	200	C/U
BISAGRAS CAZOLETA 35 USOS VARIOS			
9121022	CON RESORTE EN APERTURA	200	C/U
9121036	PARA PANEL AL RAZ	200	C/U
9121049	RUSTICA (FLORENTINA)	200	C/U
BISAGRAS CAZOLETA 40 MM			
COMUN BASE CLIP			
9121045	9120070 CODO 0	200	C/U
9121046	9120071 CODO 10	200	C/U
9121047	9120072 CODO 22	200	C/U
BISAGRAS CAZOLETA PARA PERFIL 20/20			
COMUN BASE CLIP			
9121030	9121031 BASE COMUN CODO 0	200	C/U
9121032	9120040 BASE COMUN CODO 10	200	C/U
9121033	9120041 BASE COMUN CODO 17	200	C/U



BISAGRA PARA PUERTA DE VIDRIO

9121038	CODO 17 BASE COMUN	200	C/U
9120060	CODO 17 BASE CLIP	200	C/U
9121039	TAPA BISAGRA DORADA	200	C/U
9121040	TAPA BISAGRA CROMADA	200	C/U



ACCESORIOS

9121042	TAPA PARA CUERPO DE BISAGRA	200	C/U
91210481	BASE CLIP PARA LINEA SLIDE ON	200	C/U
91210482	PIEZA INTERMEDIA P/BASE CLIP	200	C/U
91210483	ADICIONAL POR CLIP EN SLIDE ON Para convertir una bisagra de base común en clip.		
91210486	BASE REGULABLE 5'A 22'	100	C/U

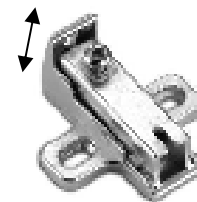

ACCESORIOS PARA BISAGRA MUNICION

Código	Descripción	X Caja	U.M.
2371101	GRAPODINA PARA 4"	1	C/U
2371102	GRAPODINA PARA 5"	1	C/U
2410257	ARANDELA	1	C/U
2410256	PERNO SUELTO LIVIANO 100	1	C/U
2371111	PERNO SUELTO REFORZADO 100	1	C/U



ACCESORIOS PARA BISAGRA FICHA

Código	Descripción	X Caja	U.M.
2190501	ARANDELA 7 MM. BRONCEADA	2	CIEN
2190502	ARANDELA 8 MM. BRONCEADA	2	CIEN
2190503	ARANDELA 8.5 MM. BRONCEADA	2	CIEN
2190504	ARANDELA 9 MM. BRONCEADA	2	CIEN
2190505	ARANDELA 10 MM. BRONCEADA	2	CIEN
2190506	ARANDELA 11 MM. BRONCEADA	2	CIEN
2190507	ARANDELA 12 MM. BRONCEADA	2	CIEN

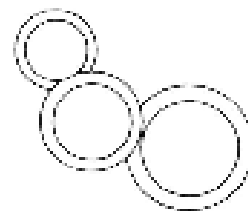

ACCESORIOS PARA POMELAS

Código	Descripción	X Caja	U.M.
2190508	2 MM. HIERRO BRONCEADO	1	CIEN
2190509	3 MM. HIERRO BRONCEADO	1	CIEN
2500220	PARA 110 BRONCE PULIDO	50	C/U
2500221	PARA 140 BRONCE PULIDO	50	C/U
2500222	PARA 160 BRONCE PULIDO	50	C/U
2500223	PARA 110 BRONCE PLATIL	50	C/U
2500224	PARA 140 BRONCE PLATIL	50	C/U
2500225	PARA 160 BRONCE PLATIL	50	C/U
2500255	CAPUCHON PARA POMELA 160 PUL	50	C/U
2500256	CAPUCHON PARA POMELA 110 PUL	50	C/U
2500257	CAPUCHON PARA POMELA 160 PLAT	50	C/U
2500258	CAPUCHON PARA POMELA 110 PLAT	50	C/U

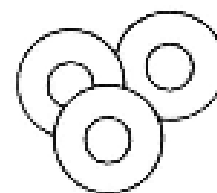

RESORTES PARA BISAGRA VAIVEN

Código	Descripción	X Caja	U.M.
3200406	RESORTE PARA CIERR MOSQUITERO	1	C/U
3200400	RESORTE BIS D/A 2"	1	C/U
3200405	RESORTE BIS D/A 2 1/2"	1	C/U
3200401	RESORTE BIS D/A 3"	1	C/U
3200402	RESORTE BIS D/A 4"	1	C/U
3200403	RESORTE BIS D/A 5"	1	C/U
3200404	RESORTE BIS D/A 6"	1	C/U



CERRADURAS ACYTRA

Código	Descripción	X Caja	U.M.
CERRADURAS DE SEGURIDAD			
1050101	101 P/C FTE NIQUEL 2 PERNOS	1	C/U
1050102	102 P/P FTE NIQUEL 2 PERNOS	1	C/U
10501020	105 P/C FTE BRONCEADO	1	C/U
1050113	110 P/C FTE NIQUEL 2 PERNOS Llave Plana	1	C/U
1050103	121 P/C FTE NIQUEL 2 PERNOS	1	C/U
1050104	122 P/P FTE NIQUEL 2 PERNOS	1	C/U
1050105	131 P/C FTE NIQUEL PASADOR RECTO	1	C/U
1050106	132 P/P FTE NIQUEL PASADOR RECTO	1	C/U
1050107	151 P/C FTE BRONCE 2 PERNOS	1	C/U
1050108	152 P/P FTE BRONCE 2 PERNOS	1	C/U
1050114	174 P/C FTE NIQUEL PASADOR RECTO	1	C/U
1050115	175 P/C FTE BDO PASADOR RECTO	1	C/U
1050120	8001 MARA COMPUTADA	1	C/U
CERRADURAS ANGOSTAS			
1050301	301 FTE NIQUEL VAIVEN	1	C/U
1050302	351 FTE BRONCE VAIVEN	1	C/U
1050306	613 P/C FTE BRONCE	1	C/U
1050309	610 P/C FTE NIQUEL	1	C/U
1050307	701 FTE NIQUEL CORREDIZA	1	C/U
1050308	751 P/C FTE BERONCE CORREDIZA	1	C/U
CERRADURAS VARIAS			
1050209	221 P/PORTERO ELECT. F/NIQ.	1	C/U
1050210	271 P/PORTERO ELECT. F/BCE	1	C/U
CERROJOS			
1050201	201 FTE NIQUEL 2 PERNOS	1	C/U
1050202	251 FTE BRONCE 2 PERNOS	1	C/U
1050303	401 FTE NIQUEL 2 PERNOS ANGOSTA	1	C/U
1050304	451 FTE BRONCE 2 PERNOS ANGOSTA	1	C/U
1050203	501 FTE NIQUEL 2 PERNOS	1	C/U
1050215	520 FTE NIQUEL 2 PERNOS Llave Plana	1	C/U
1050204	551 FTE BRONCE 2 PERNOS	1	C/U

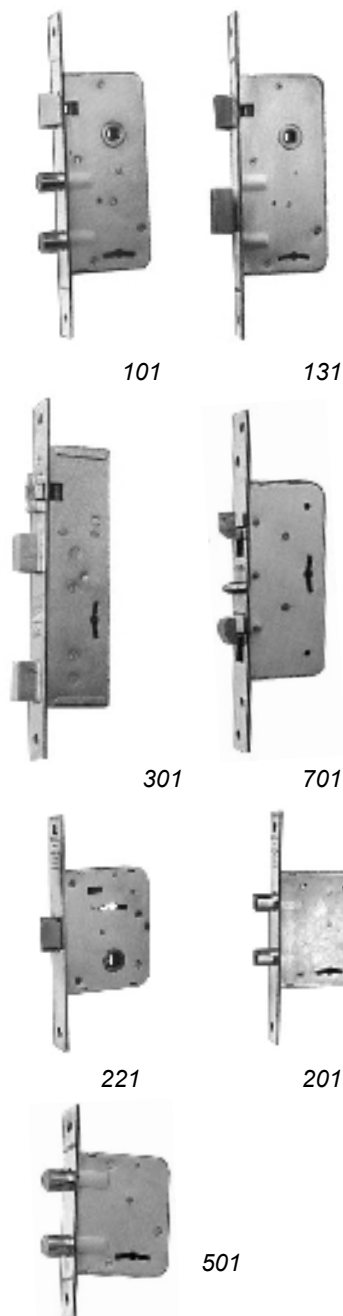

CERRADURAS CILINDRICAS

Código	Descripción	X Caja	U.M.
9070110	YANK ESF. LLAVE-BOTON ACERO	30	C/U
9070111	YANK ESF. LLAVE-BOTON DORADA	30	C/U
9070112	YANK TUL. LLAVE-BOTON ACERO	30	C/U
9043301	MANIJA KABAH LLAVE BOTON	1	C/U
3240250	MERONI NOVA 13 NEGRA	1	C/U
3240255	MERONI NOVA 13 ACERO	1	C/U

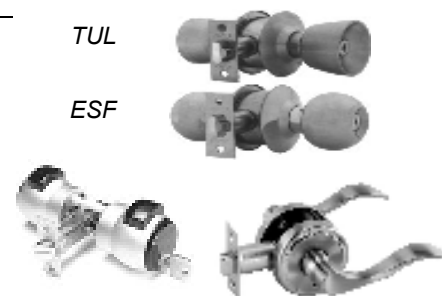

CERRADURAS AN DIF

Código	Descripción	X Caja	U.M.
CERRADURAS DE SEGURIDAD			
1070100	101 FTE ZINCADO 2 PERNOS	1	C/U
1070125	851 FTE ZINCADO PAS. RECT.	1	C/U
1070126	852 FTE ZINCADO PAS. RECT.	1	C/U
1070129	855 FTE ZINCADO PAS. RECT.	1	C/U
1070131	857 FTE ZINCADO PAS. RECT.ANGOSTA	1	C/U
1070132	857/40 FTE ZINC PAS. RECT. ANGOSTA	1	C/U
CERROJOS DE SEGURIDAD			
1070208	501 FTE ZINCADO 2 PERNOS	1	C/U
1070209	504 FTE CINCO (TIPO TH 504)	1	C/U
CERROJOS PARA CRISTAL			
1070119	530 FTE PLATIL PAS. RECT.	1	C/U
1070121	555 FTE PULIDO PAS. RECT.	1	C/U
1070124	850 2 PER.A MARCO (COMPONENTE)	1	C/U
1070127	853 PULIDO 2 PERNOS POSTIZO	1	C/U
1070128	854 PLATIL 2 PERNOS POSTIZO	1	C/U
1070130	856 2 PERN. A PISO (COMPONENTE)	1	C/U

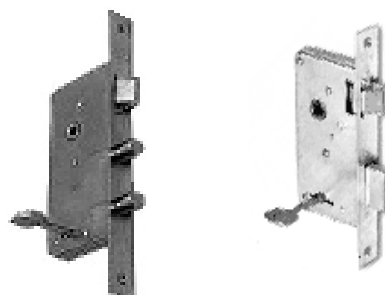

101

851

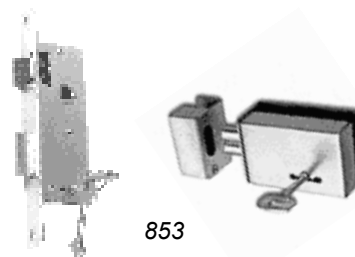

853

857

CERRADURAS ANUAC

Código	Descripción	X Caja	U.M.
1290101	101-1 LLAVE FTE HIERRO	50	C/U
1290102	102-1 LLAVE FTE HIERRO	50	C/U



CERRADURAS CANDEX

Código	Descripción	X Caja	U.M.
CERRADURAS DE 6 COMBINACIONES			
1120101	100 FTE NIQUEL PAS. RECT.	1	C/U
1120103	101 FTE NIQUEL 2 PERNOS	1	C/U
1120110	111 FTE ZINCADO 2 PERNOS	1	C/U
1120116	118 FTE ZINCADO 2 PERNOS	1	C/U
CERRADURAS PARA CORTINAS			
1120109	110 PARA CORTINA	1	C/U
CERRADURAS DE 4 COMBINACIONES			
1120111	114 FTE ZINCADO PAS. RECT.	1	C/U
1120112	115 FTE ZINCADO PAS. RECT.	1	C/U
1120113	116 FTE ZINCADO PAS. RECT.	1	C/U
1120114	117 FTE ZINCADO PAS. RECT.	1	C/U
1120115	117 FTE ZINCADO 2 PERNOS (R)	1	C/U
1120216	124 FTE ZINCADO (116 LIVIANA)	1	C/U
1120219	125 FTE ZINCADO (115 LIVIANA)	1	C/U



100

101

110

111



114

115

116

117

CERRADURAS ANGOSTAS

1120120	120 FTE ZINCADO PAS. RECT. ANG.	1	C/U
1120121	121 FTE ZINCADO PAS. RECT. ANG.	1	C/U
1120122	123 FTE ZINCADO CORREDIZA	1	C/U
1120217	127 FTE ZINCADO CERROJO PAS.REC.	1	C/U



118 120 121 123

CERROJOS DE SEGURIDAD

1120201	104 FTE ZINCADO PASADOR RECTO	1	C/U
1120205	108 FTE ZINCADO DOS PERNOS	1	C/U
1120206	109 ARRIMAR 2 PERNOS CORTOS	1	C/U
1120207	109 ARRIMAR 2 PERNOS LARGOS	1	C/U
1120215	122 FTE ZINCADO 2 PERNOS	1	C/U
1120218	128 FTE ZINCADO 2 PER.(ACY 501)		



104 108 109PL DER

CERROJOS DE PARA MUEBLE

1120208	112 EMBUTIR	1	C/U
1120210	113 ARRIMAR REVERSIBLE	1	C/U
1120211	119 EMBUTIR	1	C/U
1120212	119 ARRIMAR DERECHO	1	C/U
11202120	119 ARRIMAR IZQUIERDO	1	C/U
1120213	119 MEDIO EMBUTIR DERCHO	1	C/U
11202130	119 MEDIO EMBUTIR IZQUIERDO	1	C/U
1120214	119 EMBUTIR P/CORREDIZA	1	C/U
11202140	119 ARRIMAR CORREDZO	1	C/U
11202141	119 ARRIMAR CORREDZO	1	C/U



112 112 113



119 IZQ 119 ME CORR. EMB. CORR. ARR.

CERRADURAS P/BLINDEX EYRO

Código	Descripción	X Caja	U.M.
1241001	P 17 A CIERRE A MARCO	1	C/U
1241002	P 17 B CIERRE A PISO	1	C/U



CERRADURAS ELECTRICAS POLI

Código	Descripción	X Caja	U.M.
9090110	CERRAD POLI PLATINUM ELECTRICA	4	C/U
9090112	TRANSFORMADOR P/POLI 16V.	1	C/U

OBS: Adaptable a automatizaciones. (Pag.153)

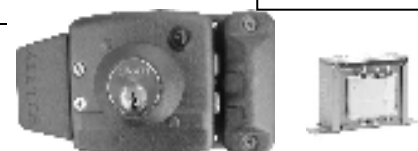

LIBERA PESTILLO ELECTRICO

Código	Descripción	X Caja	U.M.
1310102	LUBER 1500 DOBLE BOBINA	12	C/U
1310103	LUBER MINI	12	C/U
1174110	TRANSFORMADOR CON PULSADOR	1	C/U
9100101	DORCAS (P/TRANSITO PESADO)	12	C/U
9100102	DORCAS FAIL SAFE	12	C/U
1530310	JAQUE PARA CERRADURA ANTIPANICO	1	C/U
OBS: FAIL SAFE=CORRIENTE CONTINUA		1	C/U

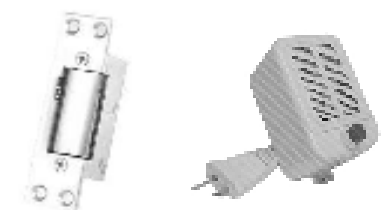

CERRADURAS ELECTROMAGNETICAS

Código	Descripción	X Caja	U.M.
3590102	FUERZA 150 KG	1	C/U
3590103	FUERZA 300 KG	1	C/U
3590120	HERRAJE "L"	1	C/U
3590125	HERRAJE "Z"	1	C/U



CERRADURAS DE SEGURIDAD ELEFANTE

Código	Descripción	X Caja	U.M.
1230201	1101 FTE ZINC ANGOSTA CILINDRO	1	C/U
1230301	1400 FTE ZINC CAJA GR. CILINDRO	1	C/U
1230407	2601 FTE ZINC.CAJA CH. CILINDRO	1	C/U
1230605	5000 FTE ZINC. P/CORTINA CILINDRO	1	C/U
1230501	510 FTE ZINC. D/PAL(=2600)	1	C/U
1230502	7010 FTE ZINC D/PAL(=1400)	1	C/U

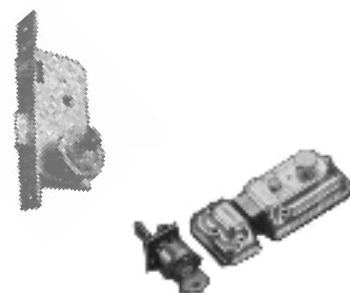

CERROJOS A CILINDRO

1230601	3000 DE APLICAR	1	C/U
---------	-----------------	---	-----

CERRADURAS GIACO

Código	Descripción	X Caja	U.M.
1320101	ART 1005 (compatible prive 200)	12	C/U
1320102	ART 1105 (compatilbe prive 205)	12	C/U
1320105	ART 1120 caja chica frente corto	12	C/U
1320106	ART 1125 caja chica frente grande	12	C/U



CERROJOS

1320201	ART 1003 FTE ZINCADO 2 PERNOS	12	C/U
---------	-------------------------------	----	-----

CERRADURAS ANTIPANICO JAQUE

Código	Descripción	X Caja	U.M.
ANTIPANICO "PUSH" (BARRA)			
1530101	HOJA SIMPLE TODA NEGRA	1	C/U
1530102	HOJA DOBLE TODA NEGRA	1	C/U
OBS: CON BARRA ROJA, INCLUYEN ACCESO EXTERIOR			



Manijon Acc. Exterior

COMPONENTES INDIVIDUALES

1530201	BARRAL ROJO X 1.00 MT	1	C/U
1530210	JUEGO DE FALLEBAS	1	C/U
1530211	VARILLAJE PARA FALLEBAS	1	C/U
1530220	PAR DE MANIJONES	1	C/U
1530222	MANIJA EXTERIOR LLAVE MULTIP.	1	C/U
1530230	POMO EXTERIOR LLAVE MULTIPUNTO	1	C/U



"push" doble

ANTIPANICO TOUCH (TIPO TECLA)

1530160	BARRA ANTIPANICO SIMPLE TOUCH *	1	C/U
1530161	MANIJA EXT P/TOUCH NEGRA	1	C/U
1530162	MANIJA EXT P/TOUCH GRIS	1	C/U

OBS.: *COLORES NEGRO CON ROJO
 SISTEMA TOTALMENTE APLICADO
 CERRADURA EXTERIOR CON MANIJA O POMO Y LLAVE



Barral Touch

CERRADURAS COMUNES KALLAY

Código	Descripción	X Caja	U.M.
1100101	501 FTE NIQ. COMÚN REF.	1	C/U
1100103	501 FTE BCE. COMÚN REF.	1	C/U
1100109	502 FTE NIQ. BAÑO REF.	1	C/U
1100111	502 FTE BCE. BAÑO REF.	1	C/U
1100117	503 FTE. NIQ COMÚN LIV.	1	C/U
1100118	503 FTE. BDA COMÚN LIV.	1	C/U
1100121	504 FTE. NIQ COMÚN LIV.	1	C/U
1100122	504 FTE. BDA COMÚN LIV.	1	C/U
1100123	504 FTE. BCE COMÚN LIV.	1	C/U
1100125	505 FTE NIQ BAÑO REF.	1	C/U
1100126	505 FTE BDO BAÑO REF.	1	C/U
1100130	506 FTE NIQ BAÑO REF.	1	C/U
1100131	506 FTE BDO BAÑO REF.	1	C/U
1100401	2025 FTE NIQ PICAPORTE	1	C/U
1100402	2025 FTE BDO PICAPORTE	1	C/U



CERRADURAS PARA CORREDIZA

1100202	507 FTE BDO COMÚN	1	C/U
1100201	507 FTE NIQ COMÚN	1	C/U
1100206	508 FTE BDO CONTRACAJA	1	C/U
1100205	508 FTE NIQ CONTRACAJA	1	C/U
1100213	517 FTE NIQ SIN TIRADOR	1	C/U
1100214	517 FTE BDA SIN TIRADOR	1	C/U



CERRADURAS DE SEGURIDAD

1100309	2004 FTE NIQ PARA CORTINA	1	C/U
1100507	4000 FTE NIQ 2 PERNOS	1	C/U
1100508	4000 FTE BDO 2 PERNOS	1	C/U
1100511	4001 FTE NIQ 2 PERNOS	1	C/U
1100512	4001 FTE BDO 2 PERNOS	1	C/U
1100515	4002 FTE NIQ 2 PERNOS	1	C/U
1100516	4002 FTE BDO 2 PERNOS	1	C/U
1100519	4003 FTE NIQ PAS. RECT.	1	C/U
1100520	4003 FTE BDO PAS. RECT.	1	C/U
1100523	4005 FTE NIQ PAS. RECT.	1	C/U
1100524	4005 FTE BDA PAS. RECT.	1	C/U
1100601	4006 FTE.NIQ.PAS.RECT(EN BOLSA)	1	C/U
1100602	4006 FTE BDO PAS. RECT	1	C/U
1100605	4007 FTE NIQ 2 PERNOS	1	C/U
1100606	4007 FTE BDO 2 PERNOS	1	C/U



CERROJOS DOBLE PALETA

1100501	3011 FTE NIQ PLACARD	1	C/U
1100503	3012 FTE NIQ PLACARD (CORREDIZA)	1	C/U
1100609	4010 FTE NIQ 2 PERNOS	1	C/U
1100610	4010 FTE BDA 2 PERNOS	1	C/U
1100617	4011 FTE NIQ 2 PERNOS	1	C/U
1100625	4015 FTE NIQ PARA CORREDIZA	1	C/U
1100626	4015 FTE BCE PARA CORREDIZA	1	C/U
1100701	4017 FTE NIQ 2 PERNOS	1	C/U

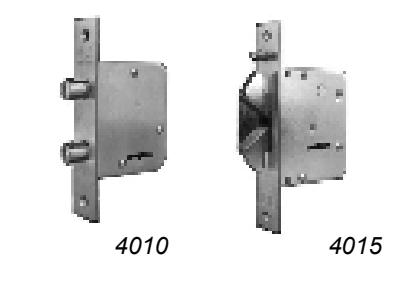

CERRADURAS ANGOSTAS

1100434	3001 FTE NIQ PAS. REC.	1	C/U
1100438	3002 FTE NIQ PAS. REC. (EN BOLSA)	1	C/U
1101003	5002 FTE BCE PARA CORREDIZA	1	C/U
1101001	5002 FTE NIQ PARA CORREDIZA	1	C/U
1101103	5003 FTE BCE VAIVEN	1	C/U
1101101	5003 FTE NIQ VAIVEN	1	C/U
1101203	5006 FTE BCE 2 PERNOS	1	C/U
1101201	5006 FTE NIQ 2 PERNOS	1	C/U



CERROJOS ANGOSTOS

1101217	5012 FTE NIQ 2 PERNOS	1	C/U
1101219	5012 FTE BCE 2 PERNOS	1	C/U
1101221	5023 FTE NIQ VAIVEN	1	C/U
1101223	5023 FTE BCE VAIVEN	1	C/U
1101301	5024 FTE NIQ PICAPORTE	1	C/U
1101303	5024 FTE BCE PICAPORTE	1	C/U

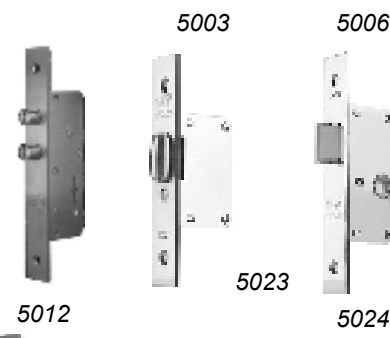

CERRADURAS A CILINDRO

1100303	2001 BRONCE	1	C/U
1100301	2001 NIQUEL	1	C/U
1100312	2006 P EUROCILINDRO COMPUTADA	1	C/U



CERRADURAS VARIAS

1101407	1017 P/PERFIL VITRINA DERECHA	10	C/U
1101408	1017 P/PERFIL VITRINA IZQUIERDA	10	C/U
1101401	6000 BRONCE PARA BLINDEX	1	C/U
1100402	6000 PLATIL PARA BLINDEX	1	C/U

OBS.: Art.6000 cerradura postiza compuesta por dos cerrojos igual combinación, uno exterior y otro interior.

CERRADURAS DE SEGURIDAD MAC

Código	Descripción	X Caja	U.M.
CERRADURAS			
1301001	41-1101 HIERRO	1	C/U
1301003	42-1101 CONSORCIO	1	C/U
1301010	43-1101 AUTOMÁTICA	1	C/U
1301020	44-1101 CILINDRO EUROPEO	1	C/U
OBS.: Art 41, la llave entra en ambas posiciones pero solo abre en una. Art 42, la llave entra y abre en cualquier posición que se inserte.			
CERROJOS			
1301101	40-1701 HIERRO	1	C/U



CERRADURAS PRIVE

Código	Descripción	X Caja	U.M.
CERRADURAS COMUNES			
1090101	101-1 LLAVE FTE HIERRO	60	C/U
1090107	101-50 MM (CAJA ANGOSTA)	60	C/U
1090109	102-1 LLAVE FTE HIERRO	60	C/U
1090116	104 FTE ZINC REFORZADA C/GRANDE	30	C/U
1090121	105 FTE CINCO BAÑO F/CHICO	60	C/U
1090124	106 FTE CINCO BAÑO F/GRANDE	60	C/U
1090128	107 FTE NIQ REFORZADA C/CHICA	30	C/U
1090129	107 FTE BCE REFORADA C/CHICA	30	C/U
1090132	108 FTE CINCO PICAPORTE	40	C/U
1090136	109 FTE NIQ BAÑO REFORZADA	30	C/U
1090215	120 FTE CINCO P/CORREDIZA	30	C/U
1090216	121 FTE CINCO CONTRACAJA	30	C/U
CERRADURAS CILINDRO			
1090201	110 REFORZADA CINCADE	30	C/U
1090203	110 REFORZADA BRONCE	30	C/U
1090207	113 CINCADE	30	C/U
1090209	113 BRONCE	30	C/U
1090211	115 NIQUELADA COMPUTADA	30	C/U
CERRADURAS D/PALETA			
1090223	200 FTE CINCO PAS. RECT. EN BOLSA	50	C/U
1090217	200 FTE CINCO PAS. RECT. EN CAJA	30	C/U
1090218	200 FTE NIQ PAS. RECT.	30	C/U
1090219	200 FTE BCE PAS. RECT.	30	C/U
1090227	201 FTE NIQ 2 PERNOS C/GRANDE	30	C/U
1090228	201 FTE BCE2 PERNOS C/GRANDE	30	C/U
1090241	205 FTE CINCO 2 PERNOS (GRANEL)	50	C/U
1090235	205 FTE CINCO 2 PERNOS C/MEDIANA	30	C/U
1090237	205 FTE BCE 2 PERNOS C/MEDIANA	30	C/U
1090244	207 FTE CINCO PAS. RECT. F/CHICO	50	C/U
1090246	208 FTE CINCO PAS. RECT. F/GRANDE	50	C/U
CERRADURAS ANGOSTAS			
1090234	204 NIQUEL 2 PERNOS	50	C/U
1090243	206 NIQUEL PAS. RECT. EN BOLSA	50	C/U
1090242	206 NIQUEL PAS. RECT. EN CAJA	50	C/U
OBS.: CERRADURA PARA BATIENTE DE 40 MM.			
CERROJOS DE SEGURIDAD			
1090231	202 FTE CINCO 2 PERNOS C/CHICA	40	C/U
1090232	203 FTE NIQ 2 PERNOS C/GRANDE	40	C/U
1090301	209 FTE NIQ PAS. REC. C/CHICA	40	C/U
1090302	210 FTE NIQ 2 PERNOS C/CHICA	40	C/U
1090304	211 FTE NIQ 3 PERNOS C/CHICA	40	C/U
1090305	212 FTE NIQ CORREDIZO C/CHICA	40	C/U
1090306	213 FTE NIQ LEVADIZO C/CHICA	40	C/U
1090320	214 FTE NIQ P/CORREDIZO	50	C/U
1090321	216 NIQ CERROJO DE ARRIMAR	40	C/U
ACCESORIOS			
1090413	CILINDRO PRIVE 110-113-117 YALE	1	JUEGO

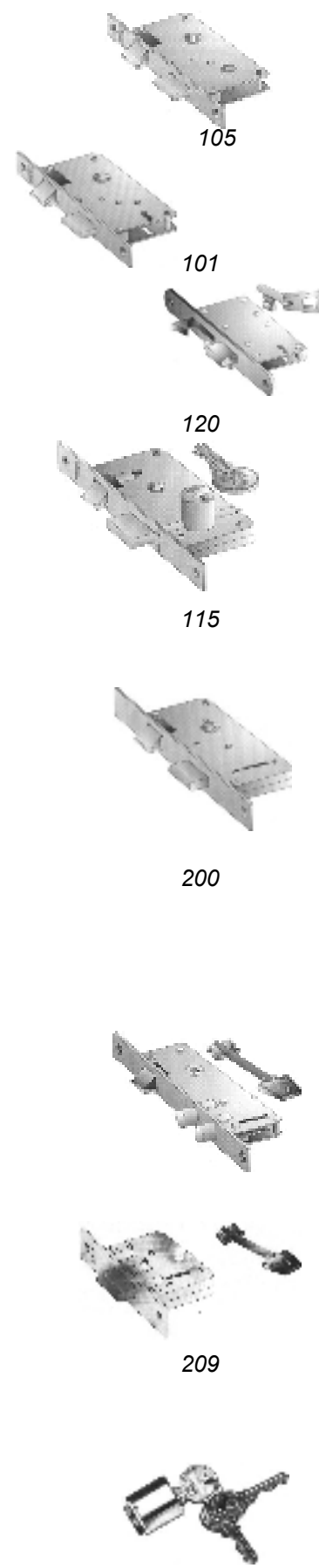

1090414	CILINDRO PRIVE 117 COMP	1	JUEGO
1090420	CILINDRO PRIVE 115	1	JUEGO

CERRADURAS ROA

Código	Descripción	X Caja	U.M.	
CERRADURAS				
1250501	108 FTE NIQ 2 PERNOS	1	C/U	
1250502	108 FTE BCE 2 PERNOS	1	C/U	
1250506	508 FTE NIQ 2 PERNOS CONSORCIO	1	C/U	
1250507	558 FTE BCE2 PERNOS CONSORCIO	1	C/U	
1250503	109 FTE NIQ PAS. RECT.	1	C/U	
1250510	110 FTE NIQ ANGOSTA	1	C/U	
1250512	111 FTE NIQ 2 PERNOS	1	C/U	
1250520	118 FTE NIQ.CORTO (TIPO 1020)	1	C/U	
1250521	119 FTE NIQ.LARGO (TIPO 1025)	1	C/U	
1250310	901 (6624) FTE CINCADO	12	C/U	
1250311	902 (1020) FTE CINCADO	12	C/U	
1250312	903 (1025) FTE CINCADO	12	C/U	
CERROJOS DE SEGURIDAD				
1250202	154 FTE BCE 2 PERNOS	1	C/U	
1250201	104 FTE NIQ 2 PERNOS	1	C/U	
CERROJOS PARA PLACARD				
1250204	105 FTE CINC.EMBUTIR PAS.RECT.	12	C/U	
1250206	106 FTE CINC ARRIMAR	12	C/U	
1250207	107 FTE CINC CORREDIZO	12	C/U	

CERRADURAS SEB

Código	Descripción	X Caja	U.M.	
CERROJOS VAIVEN				
1280101	1001/13 FTE CINC P/BAÑO	6	C/U	
1280102	1001/40 FTE BCE P/BAÑO	6	C/U	
1280103	1001/41 FTE PLAT P/BAÑO	6	C/U	
1280201	1501/13 FTE CINC P/PLACARD	6	C/U	
1280202	1501/40 FTE BCE P/PLACARD	6	C/U	
1280203	1501/41 FTE PLAT P/PLACARD	6	C/U	
CERRADURAS P/CORREDIZA				
1280312	2061/13 FTE CINC P/CORREDIZA	1	C/U	
1280313	2061/40 FTE BCE P/CORREDIZA	1	C/U	
1280301	2001/13 FTE CINCADO C/TIRADOR	1	C/U	
1280302	2001/40 FTE BRONCE C/TIRADOR	1	C/U	
1280303	2001/41 FTE BR.PLATIL C/TIR.	1	C/U	
1280306	2030/13 FTE CINC. ECONOMICA	1	C/U	

CERRADURAS STAR



Código	Descripción	X Caja	U.M.
--------	-------------	--------	------

CERRADURAS DE SEGURIDAD LIVIANAS

9050101	ART.230 FTE CINC AMARILLO CHICO	50	C/U
9050102	ART.230 FTE CINC AMARILLO GRANDE	50	C/U
9051001	ART.210 FTE CINC.AM EN CAJA	24	C/U
9051002	ART.210 FTE CINC.AM.EN BOLSA	50	C/U
9051005	ART.210 S FTE.CINC.AM. EN CAJA	24	C/U
9051006	ART.210 S FTE.CINC.AM EN BOLSA	50	C/U

OBS.: 210=PASAD.RECT.; 210 S= DOS PERNOS

230 es compatible con 1020-1025

210 es compatible con 6624-6625

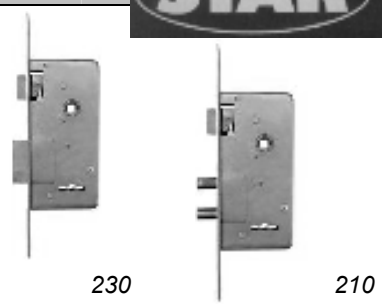

CERRADURAS DE SEGURIDAD REFORZADAS

9051010	ART. 101 FTE NIQ 2 PERNOS	24	C/U
9051011	ART. 101 FTE BCE 2 PERNOS	24	C/U
9051015	ART. 810 FTE NIQ 2 PERNOS	24	C/U
9051016	ART. 810 C FTE.NIQUEL DOS PERNOS	24	C/U

OBS.: 101 ES COMPATIBLE CON MOD.101-4000-

3101. Y 810 ES COMPATIBLE CON 2105

810 C ES COMPATIBLE CON 2107

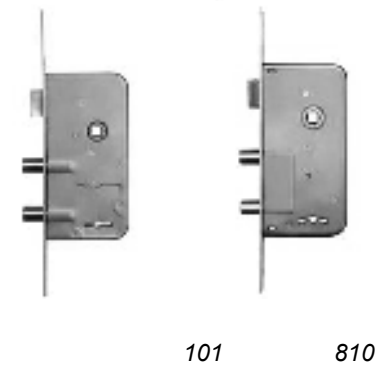

CERRADURAS ANGOSTAS

9051020	ART. 710 2 PERNOS	24	C/U
9051021	ART. 720 FTE.NIQUEL (SIM.206)BOLSA	50	C/U
9051022	ART. 720 FTE.NIQUEL (SIM.206)	24	C/U

OBS.: ART.710 COMPATIBLE CON MOD.610/601

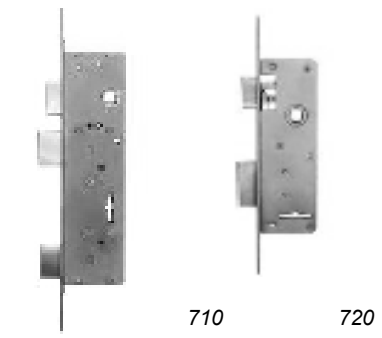

CERROJOS DE SEGURIDAD

9051107	ART. 225 P/CORREDIZA	36	C/U
9051101	ART. 501 FTE NIQ 2 PERNOS (ACY501)	36	C/U
9051105	ART. 525 FTE NIQ CORREDIZO (KA4015)	36	C/U
9051110	ART. 700 FTE NIQ 2 PERNOS ANGOSTO	36	C/U
9051115	ART. 800 FTE NIQ 2 PERNOS (TRABEX5105)	36	C/U
9051113	ART. 200 FTE NIQUEL DOS PERNOS	36	C/U

OBS.: ART.501 COMPATIBLE CON MOD.501/4010/5101

ART.700 COMPATIBLE CON MOD.401,ART.800 CON 5105

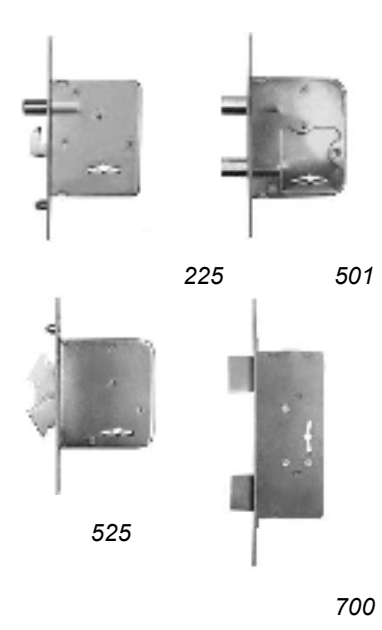

CERRADURAS TRABEX

Código	Descripción	X Caja	U.M.
CERRADURAS DE SEGURIDAD			
1110103	1020 FTE NIQ PAS. RECT. F/CHICO	12	C/U
1110104	1025 FTE NIQ PAS. RECT. F/GRANDE	12	C/U
1110107	2102 FTE BCE 2 PERNOS F/GRANDE	12	C/U
1110109	2103 FTE NIQ PAS. RECT. F/GRANDE	12	C/U
1110111	2104 FTE NIQ 2 PERNOS F/GRANDE	12	C/U
1110113	2105 FTE NIQ 2 PERNOS F/GRANDE	12	C/U
1110114	2107 FTE NIQ 2 PERNOS F/CHICO	12	C/U
1110126	3002 PARA CORTINA	12	C/U
1110117	6624 FTE NIQ PAS. RECT.	12	C/U
1110119	6625 FTE NIQ 2 PERNOS	12	C/U
1110127	3101 FTE NIQ 2 PERNOS (ACY101)	12	C/U



1020 2103



3002



2105

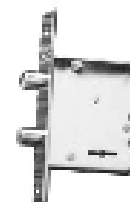

5105

CERROJOS

1110201	1103 FTE NIQ PAS. RECT.	12	C/U
1110202	1201 FTE NIQ PAS. RECT.	12	C/U
1110205	5105 FTE NIQ 2 PERNOS	12	C/U
1110206	624 FTE CINC PAS RECT 4 PLACAS	12	C/U
1110207	625 FTE CINC DOS PER. 4 PLACAS	12	C/U
1110210	5101 FTE.NIQ.2 PERNOS (ACY.501)	12	C/U
1110220	700 P/CORREDIZA (IDEM K.5002)	12	C/U

CERRADURAS YALTRES



Código	Descripción	X Caja	U.M.
CERRADURAS DE EMBUTIR			
1140100	7P PASADOR RECT. LLAVE CRUZ	1	C/U
1140101	7P DOS PERNOS LLAVE CRUZ	1	C/U
1140150	7P CEC PAS.RECT. COMPUTADA	1	C/U
1140105	7P CEC DOS PERNOS COMPUTADA	1	C/U
1140170	7P CEC AUTOMATICA DOS PERNOS	1	C/U
1140195	SMY 2 MULTIANCLAJE	1	C/U



SMY2



7 PCEC

CERROJOS DE EMBUTIR

1140205	N:3 DOS PERNOS LLAVE CRUZ	1	C/U
1140219	N:7 TRES PEROS LLAVE CRUZ	1	C/U
1140180	N:7 CEC COMPUTADO	1	C/U
1140221	N:11 UN PERNO LLAVE CRUZ	1	C/U
1140301	N:12 PARA BAUL (PAR COMBINADO)	1	C/U
1140304	N:12 FALLEBA CENTRAL	1	C/U
1140196	MULTIANCLAJE COMPUTADA CM	1	C/U



N.3

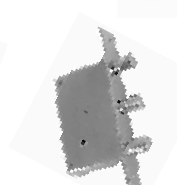

N.7



N.11



N.12

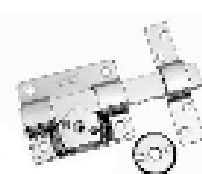

6LE

CERROJOS DE APLICAR

1140207	N:5 ACERO INOXIDABLE	1	C/U
1140215	N:6 BCE. LLAVE CORTA	1	C/U
1140212	N:6 CROMO LLAVE CORTA	1	C/U
1140216	N:6LE BCE. LLAVE LARGA	1	C/U
1140213	N:6LE CROMO LLAVE LARGA	1	C/U
1140217	N:6 LE ROSCADO CROMO	1	C/U
1140186	N:606-50 COMPUTADO CROMO	1	C/U
1140190	N:606-50 COMPUTADO BRONCE	1	C/U

CERRADURAS OCHO BLOQ

Código	Descripción	X Caja	U.M.
1300101	08-MS10 FAMILIAR	1	C/U
1300105	09-MS10 E-CONSORCIO	1	C/U
1300401	10-MS10 H-AUTOM.	1	C/U
1300109	11-MS 120 MULTIANCLAJE	1	C/U

OBS.: 08 La llave entra en ambos sentidos pero solo abre en uno.
09 La llave abre en ambos sentidos.

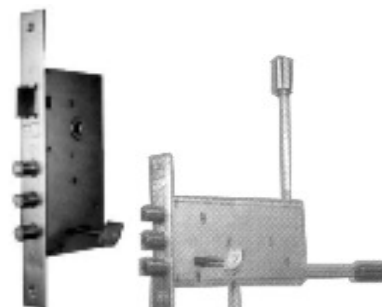

MS 10

MS 02

CERROJOS DE SEGURIDAD

1300201	01-MS 01 - 3 PERNOS	1	C/U
---------	---------------------	---	-----

CERRADURAS PARA BLINDEX

1300305	06-MS 55 FTE.BCE.	1	C/U
---------	-------------------	---	-----

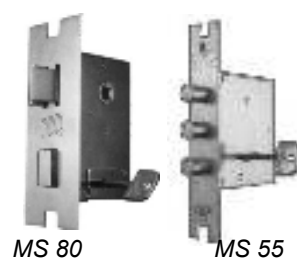

MS 80

MS 55

Código	Descripción	X Caja	U.M.
1300601	12-CAS 01 2 PERNOS	1	C/U

Código	Descripción	X Caja	U.M.
1300501	15-CAS 10	1	C/U
1300505	17-CAS 120 MULTIANCLAJE	1	C/U



CAS 01

CERRADURAS P/PLEGADIZAS

Código	Descripción	X Caja	U.M.
2430901	FRENTE DE BRONCE	1	C/U
2430902	FRENTE DE PLATIL	1	C/U



CERROJOS P/CORREDIZAS

Código	Descripción	X Caja	U.M.
2430701	P/CUBETA MN FTE BRONCE	6	C/U
2430703	P/CUBETA MN F/PLATIL	6	C/U

OBS: Ver cubeta con vástago en la pag.84

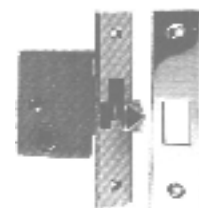

TIPOS MAS USUALES DE CERRADURAS.:

Si bien es muy grande la variedad y medidas de cerraduras que existen, podemos agrupar una buena cantidad de ellas en los siguientes tipos o familias mas comunes:

***Cerraduras de llave común frente corto.:**

Frente de 185x20 y caja de 125x65, llave común

Algunas marcas: Prive 101; Kallay 503.

***Cerraduras de llave común frente largo.:**

Frente de 212x25 y caja de 125x65, llave común

Algunas marcas: Prive 102; Kallay 504.

***Cerraduras para baño frente corto**

Frente de 185x20 y caja de 125x65 con encastre ¼" para pomo de baño.

Algunas marcas: Prive 105; Kallay 505.

***Cerraduras para baño frente largo**

Frente de 212x25 y caja de 125x65 con encastre ¼" para pomo de baño.

Algunas marcas: Prive 106; Kallay 506.

***Cerradura de seguridad caja chica, frente corto, 4 placas**

Frente de 185x20 y caja de 125x65, llave doble paleta.

Algunas marcas: Prive 207; Kallay 4005; Candex 116; Trabex 1020; Star 230 C

***Cerradura de seguridad caja chica, frente largo, 4 placas**

Frente de 212x25 y caja de 125x65, llave doble paleta.

Algunas marcas: Prive 208; Kallay 4006; Candex 115; Trabex 1025; Star 230 L

***Cerradura de seguridad medida standard pasador rectangular, 4 placas**

Frente de 222x25 y caja de 140x65; llave doble paleta

Algunas marcas: Prive 200, Kallay 4003; Candex 117; Trabex 6624; Star 210

***Cerradura de seguridad medida standard dos pernos redondos; 4 placas**

Frente de 222x25 y caja de 140x65; llave doble paleta

Algunas marcas: Prive 205, Kallay 4002; Candex 117R; Trabex 6625; Star 210S

***Cerradura de seguridad caja reforzada dos pernos, 6 placas**

Frente de 240x26 y caja de 150x73; llave doble paleta

Algunas marcas: Acytra 101; Kallay 4000; Trabex 3101; Star 101; Roa 108

***Cerradura de seguridad angosta 4 placas**

Frente de 183x21 y caja de 125x40

Algunas marcas: Prive 206; Star 720; Candex 121; Andif 857

***Cerrojo de seguridad caja liviana dos pernos, 4 placas**

Frente de 140x25 y caja de 80x66; llave doble paleta

Algunas marcas: Star 200S; Prive 210; Giaco 1003; Candex 122; Trabex 625

***Cerrojo de seguridad caja reforzada dos pernos, 6 placas**

Frente de 172x26 y caja de 82x65; llave doble paleta

Algunas marcas: Star 501; Acytra 501; Candex 128; Kallay 4010; Trabex 5101

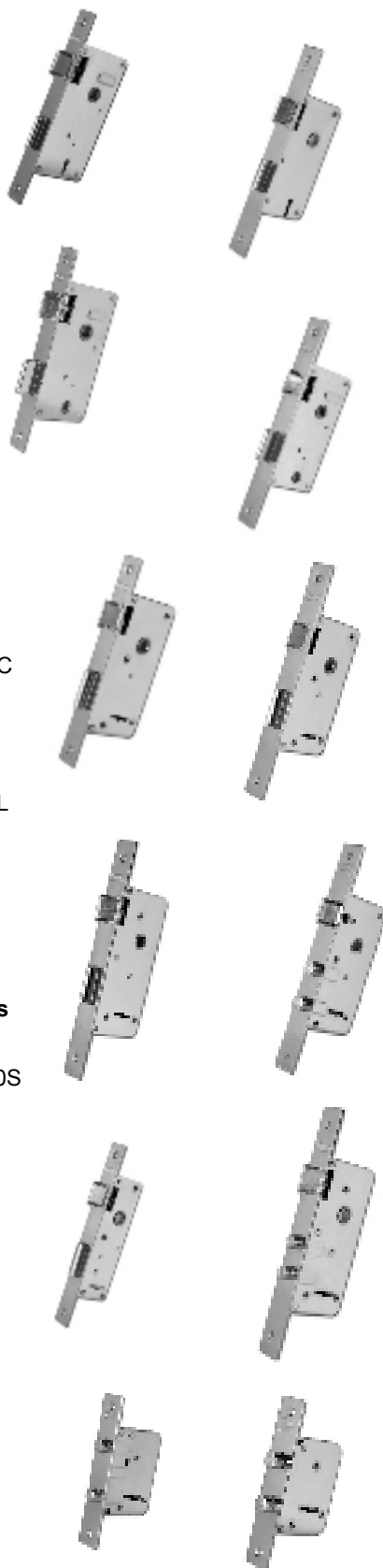

CUADRO DE MEDIDAS Y REEMPLAZOS DE CERRADURAS

Marca	Caja	Frente	Reem.	Marca	Caja	Frente	Reem.	Marca	Caja	Frente	Reem.
Acytra				Giaco				Star			
101/151	150x73	240x26	Star101	1003	80x66	140x25		210	139x64	222x25	Pri.200
121	150x66	238x26		1005	140x62	224x25	Pri.200	101	146x71	238x26	Acy.101
131	145x65	238x26		Kallay				810	143x70	238x28	Tr.2105
174/175	140x66	238x26	Prive200	501/502	130x62	220x25		710	175x47	243x28	Acy.601
301/351	178x47	221x26		503/505	125x63	185x20	Pri.101	501	83x66	141x26	Acy.501
601/651	178x47	240x26	Star710	504/506	125x63	215x25	Pri.102	525	85x75	150x25	Ka.4015
701/751	128x53	240x26		2025	77x65	135x25		700	118x47	190x28	Acy.401
221/271	95x74	216x26		507/508	150x70	220x25		800	83x70	143x28	Tr.5105
201/251	95x74	182x26		2004	170x61			810 C			Tr.2107
401/451	122x47	128x26	Star700	4000	148x72	239x27	Acy.101	Teache			
501/551	82x65	172x26	Star501	4001	150x67	220x25		301	125x65	210x25	Pri.208
520	82x65	140x26		4002/3	140x63	220x25		302	125x65	185x20	Pri.207
851/871	60x55	100x16		4004	150x67	220x25		303	140x65	225x25	Pri.200
An Dif				4005	125x63	185x20		400	150x70	240x25	Acy.101
101	148x71	239x25	Acy.101	4006	125x63	212x25		403	140x65	225x25	Pri.205
851	125x60	183x21	Pri.207	4007	148x72	238x27	Acy.110	504	80x65	140x25	Giaco.
852	125x60	216x24	Pri.208	3011/12	64x46	100x17		Trabex			
855	125x60	222x24		4010	82x66	142x28	Acy.501	820	125x63	185x20	
857	125x47	183x21		4011	85x67	145x25		825	125x63	212x25	
857/40	125x40	183x21	Pri.206	4014/15	85x67	145x25	Star.525	212/3	140x69	242x28	
501	84x65	142x25		4017	82x66	142x26	Acy.520	2104/5	140x69	242x28	Star810
530/555	97x65	140x25		3001	125x48	185x21	A.D.857	2107	140x69	205x25	
850/853	45x73			5002	140x40	200x23		3002	160x50		
854/856	45x73			5003/6	175x40	240x23		6624/5	140x63	223x25	Star210
Anuac				5012	115x40	180x23		3101	148x73	238x27	Acy.101
101	127x64	185x21	Pri.101	5023/24	85x40	150x23		624/5	78x63	143x25	
102/210	127x64	216x26	Pri.102	2001	140x65	220x23		1103	80x68	143x27	
220	142x64	221x26	Pri.200	Mac				1201	80x68	143x27	
BerCol				1101	150X75	240X25		5105	80x68	143x27	Star800
Lib.Pes.	57x30	92x23		1701	85X71	162X26		5101	82x65	140x26	Acy.501
Candex				Prive				Van Dos			
100/101	145x65	237x27		101/105	126X65	186X20		401	125x63	212x25	Pri.208
110	158x60			102/106	126X65	212X25		402	125x63	184x20	Pri.207
111	145x65	237x28		104	150X70	230X25		515/7	135x60	224x25	
114	140x65	220x24		107	126X63	215X25		550	170x47	240x25	
115	125x65	213x24	Pri.208	108	83X63	140X25		616/7/8	150x70	235x27	
116	125x65	184x20	Pri.207	109	126X63	215X25		705	42x70		
117	140x65	223x24	Pri.200	120/121	126X63	212X25		710	100x70	153x25	
118	140x70	228x27		110	150X70	230X25		818	76x68	147x27	
120	169x40	243x24	Picolina	112				901	60x50	100x20	
121	126x40	189x20	Pri.206	113/115	125X65	212X25		902/3	61x50	100x20	
123	140x40	201x24	Ka.5002	200/205	140X65	222X25	Star210	904/5	60x50	154x25	
104	85x65	154x28		201	145X68	237X28		945	105x47	170x24	
108	85x65	140x26		207	125X65	183X20		946	105x47		
109	85x65			208	125X65	215X25		Yaltres			
122	73x64	131x26		204/206	125X40	185X20		7p/7pcec	140x65	240x25	
112	62x53	100x18		202	62X40	100X18		3	82x74	140x26	
113	62x53			203	83X63	154X28		7	97x60	155x25	
119	44x44	86x15		209/210	83X63	140X25		11	60x52	102x18	
Cerratex				211/212	83X63	140X25		8 Bloq			
101			Pri.101	213	83X63	140X25		Ms10	153x75	238x28	
102			Pri.102	116	83X63	140X28		Ms120	157x158	238x28	
Canoa				Roa				Ms01	85x70	160x28	
101			Pri.101	108	1498x71	240x27	Acy.101	Ms55	97x66	140x28	
102			Pri.102	109	139x65	221x26	Pri.200	Ms80			
Eyro				110	175x41	244x27					
800/801	60x57	100x20		111	139x65	221x26	Pri.205				
				104	82x65	140x26	Acy.501				
				105/6/7	44x44	86x15					

Elefante			Seb		
510	143x65	223x25	1001	61x58	99x19
1707	142x65	223x25	1501/11	61x58	99x19
1510			2061	103x70	190x25
1101	150x33	224x25	2001	150x70	255x25
1401	150x70	230x25	2209	150x70	255x25
2601	140x65	223x25	2031		
5000	212x62		2082	103x42	190x25
3000	95x65		3502	80x145	150x25

LAS PRESENTES MEDIDAS ESTAN SUJETAS A MODIFICACION POR PARTE DEL FABRICANTE

CERRADURAS CANOA

Código	Descripción	Caja	Fronte	X Caja	U.M.
CERRADURAS DE 1 COMBINACION					
1010101	14-15 MM BCEADA	40X30	70X12	12	C/U
1010102	14-20 MM BCEADA	40X35	70X12	12	C/U
1010103	14-25 MM BCEADA	40X40	70X12	12	C/U
1010104	507-20 MM BCEADA	47X35	80X14	12	C/U
1010105	507-25 MM BCEADA	47X40	80X14	12	C/U
1010106	507-30 MM BCEADA	47X45	80X14	12	C/U
1010116	702-20 DER BCEAD	45X33	80X14	12	C/U
1010117	702-20 IZQ BCEAD	45X33	80X14	12	C/U
1010124	507-20 MM BRONCE	47X40	80X14	12	C/U
1010125	507-25 MM BRONCE	47X35	80X14	12	C/U
1010126	507-30 MM BRONCE	47X45	80X14	12	C/U
1010306	514-30 VAIVEN BDA	50X50	85X15	12	C/U
1010308	514-30 VAIVEN BDA	50X50	85X15	12	C/U

OBS.: Medidas en mm.

CERRADURAS 6 COMBINACIONES

1010107	507-15/6C BCEADA	50X32	85X15	12	C/U
1010108	507-20/6C BCEADA	50X38	85X15	12	C/U
1010109	507-25/6C BCEADA	50X42	85X15	12	C/U
1010110	507-30/6C BCEADA	50X48	85X15	12	C/U
1010111	507-35/6C BCEADA	50X54	85X15	12	C/U
1010112	507-40/6C BCEADA	50X60	85X15	12	C/U
1010128	507-20/6C BRONCE	50X38	85X15	12	C/U
1010129	507-25/6C BRONCE	50X42	85X15	12	C/U
1010130	507-30/6C BRONCE	50X48	85X15	12	C/U
1010131	507-35/6C BRONCE	50X54	85X15	12	C/U
1010132	507-40/6C BRONCE	50X60	85X15	12	C/U

CERRADURAS DE APLICAR

1010301	508 BRONCE CON COMBINACION			12	C/U
1010302	508 BRONCE SIN COMBINACION			12	C/U
1010303	508 HIERRO NIQ.SIN COMBINACION			12	C/U
1010304	510 ½ EMB. 6 C			12	C/U
1010305	511 ½ EMB. 1 C			12	C/U
1010310	515 1 ARRIMAR Grande 32 X 64			12	C/U
1010311	515/2 ARRIMAR Chica 25 X 45			12	C/U
1010323	522/20 APLICAR			12	C/U
1010324	522/25 APLICAR			12	C/U
1010312	518-FALLEBA DE APLICAR 6C.			1	C/U

CERRADURAS P/CORREDIZA

1010201	513/25 1C FTE BRONCEADO			12	C/U
1010202	513/30 1C FTE BRONCEADO			12	C/U
1010215	513/30-2 1C FTE BRONCEADO			12	C/U
1010203	513/40 FTE BRONCEADO			12	C/U
1010206	513/25 1C FTE BRONCE			12	C/U
1010207	513/30 1C FTE BRONCE			12	C/U
1010216	513/30-2 1C FTE BRONCE			12	C/U
1010208	513/40 FTE BRONCE			12	C/U

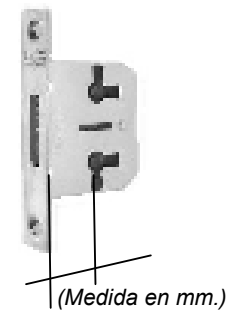

510



515



522



518



508

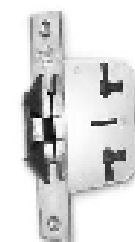

513

ACCESORIOS CANOA

1010325	LLAVE 1 COMBINACION	100	C/U
1010326	LLAVE 6 COMBINACIONES	100	C/U
1010327	LLAVE LARGA P/ 515	100	C/U
1010313	CONTRAFRENTE	100	C/U



CERRADURAS CERRATEX

Código	Descripción	Caja	Frente	X Caja	U.M.
--------	-------------	------	--------	--------	------

CERRADURAS 1 COMBINACION

1020101	600-20 BCEADA	42X32	78X14	12	C/U
1020103	602-25 BCEADA	44X38	78X14	12	C/U
1020135	601 ARRIMAR			12	C/U
1020115	411-20 BRONCE	42X32	78X14	12	C/U
1020117	412-25 BRONCE	44X38	78X14	12	C/U

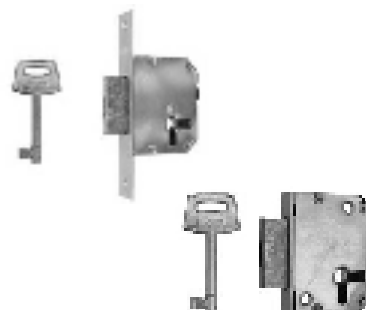

CERRADURAS 6 COMBINACIONES

1020105	610-20 MM DER	53x33	85X15	12	C/U
1020107	611-25 MM DER	53x39	85X15	12	C/U
1020109	612-30 MM DER	53x46	85X15	12	C/U
1020106	610-20 MM IZQ	53x33	85X15	12	C/U
1020108	611-25 MM IZQ	53x39	85X15	12	C/U
1020110	612-30 MM IZQ	53x46	85X15	12	C/U



OBS: Frente de hierro bronceado

CERRADURAS PARA CORREDIZA

1020111	620-25 DER	53X39	85X15	12	C/U
1020113	621-30 DER	53X46	85X15	12	C/U
1020112	620-25 IZQ	53X39	85X15	12	C/U
1020114	620-30 IZQ	53X46	85X15	12	C/U



OBS: Frente de hierro bronceado

ACCESORIOS

1020201	CONTRAFRENTE	50	C/U
1020202	LLAVE CORTA ANTIGUA	50	C/U
1020203	LLAVE LARGA ANTIGUA	50	C/U
1020204	LLAVE CORTA NUEVA	50	C/U
1020205	LLAVE LARGA NUEVA	50	C/U



CERRADURA DE ARRIMAR PLASTICAS

Código	Descripción	X Caja	U.M.
2200713	PLASTICO BLANCO	20	C/U
2200714	PLASTICO MARRON	20	C/U
2200715	PLASTICO BEIGE	20	C/U
2200716	BOCALLAVE PLASTICO	20	C/U
2200717	LLAVE PLASTICA ORO	20	C/U



CERRADURAS MERLE



Código	Artículo	Medida	X Caja	U.M.
CERRADURAS MEDIO EMBUTIR CAJON				
1040101	120-22 MM	50X40	10	C/U
1040102	120-26 MM	50X40	10	C/U
1040103	120-28 MM	50X40	10	C/U
1040104	120-33 MM	50X40	10	C/U
1040105	120-36 MM	50X40	10	C/U
1040106	120-38 MM	50X40	10	C/U
1040107	120-40 MM	50X40	10	C/U
1040108	120-44 MM	50X40	10	C/U
1040109	120-46 MM	50X40	10	C/U
1040110	125-22 MM	50X45	10	C/U
1040111	125-26 MM	50X45	10	C/U
1040112	125-28 MM	50X45	10	C/U
1040113	125-33 MM	50X45	10	C/U
1040114	125-36 MM	50X45	10	C/U
1040115	125-38 MM	50X45	10	C/U
CERRADURAS MEDIO EMBUTIR PUERTA				
1040201	220-22 MM DER	50X40	10	C/U
1040202	220-26 MM DER	50X40	10	C/U
1040203	220-28 MM DER	50X40	10	C/U
1040204	220-33 MM DER	50X40	10	C/U
1040205	220-36 MM DER	50X40	10	C/U
1040206	220-38 MM DER	50X40	10	C/U
1040207	220-40 MM DER	50X40	10	C/U
1040208	220-44 MM DER	50X40	10	C/U
1040209	220-46 MM DER	50X40	10	C/U
1040210	221-22 MM IZQ	50X40	10	C/U
1040211	221-26 MM IZQ	50X40	10	C/U
1040212	221-28 MM IZQ	50X40	10	C/U
1040213	221-33 MM IZQ	50X40	10	C/U
1040214	221-36 MM IZQ	50X40	10	C/U
1040215	221-38 MM IZQ	50X40	10	C/U
1040216	221-40 MM IZQ	50X40	10	C/U
1040217	221-44 MM IZQ	50X40	10	C/U
1040218	221-46 MM IZQ	50X40	10	C/U
1040219	225-22 MM DER	50X45	10	C/U
1040220	225-26 MM DER	50X45	10	C/U
1040221	225-28 MM DER	50X45	10	C/U
1040222	225-33 MM DER	50X45	10	C/U
1040223	225-36 MM DER	50X45	10	C/U
1040224	225-38 MM DER	50X45	10	C/U
1040228	226-22 MM IZQ	50X45	10	C/U
1040229	226-26 MM IZQ	50X45	10	C/U
1040230	226-28 MM IZQ	50X45	10	C/U
1040231	226-33 MM IZQ	50X45	10	C/U
1040232	226-36 MM IZQ	50X45	10	C/U
1040233	226-38 MM IZQ	50X45	10	C/U

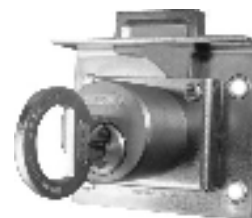

120

LA MEDIDA EN MM.
REPRESENTA EL
ESPESOR TOTAL
DE LA CERRADURA



20 mm

Ejemplo art 120

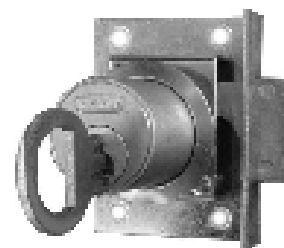

221

CERRADURAS MEDIO EMB. P/CORREDIZA

Código	Artículo	Mano	Medida	X Caja	U.M.
1040301	325-22 MM CAJON		50X45	10	C/U
1040302	325-26 MM CAJON		50X45	10	C/U
1040303	325-28 MM CAJON		50X45	10	C/U
1040304	325-33 MM CAJON		50X45	10	C/U
1040501	425-22 MM DER		50X45	10	C/U
1040502	425-26 MM DER		50X45	10	C/U
1040503	425-28 MM DER		50X45	10	C/U
1040504	425-33 MM DER		50X45	10	C/U
1040511	426-26 MM IZQ		50X45	10	C/U

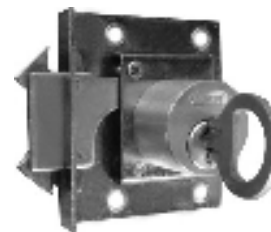

425

CERRADURAS APLICAR

1040601	511-14 MM CAJON		42X40	10	C/U
1040602	511-18 MM CAJON		42X40	10	C/U
1040603	511-20 MM CAJON		42X40	10	C/U
1040604	511-25 MM CAJON		42X40	10	C/U
1040605	511-28 MM CAJON		42X40	10	C/U
1040606	511-30 MM CAJON		42X40	10	C/U
1040607	511-32 MM CAJON		42X40	10	C/U
1040608	511-36 MM CAJON		42X40	10	C/U
1040609	511-38 MM CAJON		42X40	10	C/U
1040611	512-14 MM DER		42X40	10	C/U
1040612	512-18 MM DER		42X40	10	C/U
1040613	512-20 MM DER		42X40	10	C/U
1040614	512-25 MM DER		42X40	10	C/U
1040615	512-28 MM DER		42X40	10	C/U
1040616	512-30 MM DER		42X40	10	C/U
1040617	512-32 MM DER		42X40	10	C/U
1040621	513-14 MM IZQ		42X40	10	C/U
1040622	513-18 MM IZQ		42X40	10	C/U
1040623	513-20 MM IZQ		42X40	10	C/U
1040624	513-25 MM IZQ		42X40	10	C/U
1040625	513-28 MM IZQ		42X40	10	C/U
1040626	513-30 MM IZQ		42X40	10	C/U
1040627	513-32 MM IZQ		42X40	10	C/U



511

CERRADURAS DE APLICAR PASANTE

1040402	401-18MM CAJON			10	C/U
1040404	401-25 MM CAJON			10	C/U
1040406	401-30 MM CAJON			10	C/U
1040412	402-18 MM DER			10	C/U
1040414	402-25 MM DER			10	C/U
1040416	402-30 MM DER			10	C/U
1040422	403-18 MM IZQ			10	C/U
1040424	403-25 MM IZQ			10	C/U
1040426	403-30 MM IZQ			10	C/U
1040801	611-14 MM CAJON		42X40	10	C/U
1040802	611-18 MM CAJON		42X40	10	C/U
1040803	611-20 MM CAJON		42X40	10	C/U
1040804	611-25 MM CAJON		42X40	10	C/U



401

1040805	611-28 MM CAJON	42X40	10	C/U
1040806	611-30 MM CAJON	42X40	10	C/U
1040807	611-32 MM CAJON	42X40	10	C/U
1040811	612-14 MM PUERTA	42X40	10	C/U
1040812	612-18 MM PUERTA	42X40	10	C/U
1040813	612-20 MM PUERTA	42X40	10	C/U
1040814	612-25 MM PUERTA	42X40	10	C/U
1040815	612-28 MM PUERTA	42X40	10	C/U
1040816	612-30 MM PUERTA	42X40	10	C/U
1040817	612-32 MM PUERTA	42X40	10	C/U

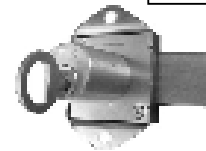

611

CERRADURAS CILINDRO DE EMPUJE

1040902	701 BRONCE CILINDRICA		10	C/U
1040903	702 BRONCE OVALADA		10	C/U
1041001	703 BRONCE P/METAL		10	C/U
1041002	704 BRONCE P/MADERA		10	C/U
1041007	710-25 MM		10	C/U
1041008	712-32 MM		10	C/U
1041009	714-38 MM		10	C/U



701



702



710



704

CERRADURAS P/GAVETAS

1041101	811-18 MM	CAJON PARA 10 MM	10	C/U
1041103	811-25 MM	CAJON PARA 17 MM	10	C/U
1041109	812-18 MM	PUERTA DER PARA 10 MM	10	C/U
1041111	812-25 MM	PUERTA DER PARA 17 MM	10	C/U
1041117	813-18 MM	PUERTA IZQ PARA 10 MM	10	C/U
1041119	813-25 MM	PUERTA IZQ PARA 17 MM	10	C/U
1041125	821-18 MM	CAJON PARA 4 MM	10	C/U
1041127	821-25 MM	CAJON PARA 11 MM	10	C/U
1041133	822-18 MM	PUERTA DER PARA 4 MM	10	C/U
1041135	822-25 MM	PUERTA DER PARA 11 MM	10	C/U
1041141	823-18 MM	PUERTA IZQ PARA 4 MM	10	C/U
1041143	823-25 MM	PUERTA IZQ PARA 11 MM	10	C/U
1041149	831-18 MM	CAJON PARA 18 MM	10	C/U
1041151	831-25 MM	CAJON PARA 25 MM	10	C/U
1041157	832-18 MM	PUERTA DER PARA 18 MM	10	C/U
1041159	832-25 MM	PUERTA DER PARA 25 MM	10	C/U
1041165	833-18 MM	PUERTA IZQ PARA 18MM	10	C/U
1041167	833-25 MM	PUERTA IZQ PARA 25MM	10	C/U



811

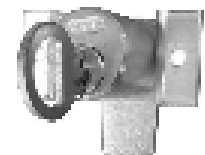

821



822



831

CERRADURAS VARIAS

1041201	901	BRONCE CON LEVA	10	C/U
1041202	903	TRABA DISCO TELEFONICO	10	C/U
1041210	905-16	CIL ROSCADO C/LEVA DER	10	C/U
1041212	905-23	CIL ROSCADO C/LEVA DER	10	C/U
1041214	905-30	CIL ROSCADO C/LEVA DER	10	C/U
1041211	906-16	CIL ROSCADO C/LEVA IZQ	10	C/U
1041213	906-23	CIL ROSCADO C/LEVA IZQ	10	C/U
1041215	906-30	CIL ROSCADO C/LEVA IZQ	10	C/U
1041204	1025	EMBUTIR	10	C/U
1041207	1101	VITRINA BRONCE NIQUELADA	10	C/U



901



903



905

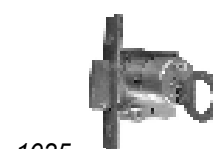

1025



1101

CERRADURAS CON CILINDRO ZAMAK

Código	Descripción	X Caja	U.M.
1041401	120 CAJON	10	C/U
1041404	125 CAJON	10	C/U
1041402	130 CAJON	10	C/U
1041405	220 PUERTA DER	10	C/U
1041406	221 PUERTA IZQ	10	C/U
1041410	225 PUERTA DER	10	C/U
1041411	226 PUERTA IZQ	10	C/U
1041420	325 PIANO / CORREDIZA CAJON	10	C/U
1041423	401 CAJON	10	C/U
1041424	402 PUERTA DER	10	C/U
1041426	403 PUERTA IZQ	10	C/U
1041425	405 CAJONERA	10	C/U
1041430	425 PUERTA CORREDIZA DER	10	C/U
1041431	426 PUERTA CORREDIZA IZQ	10	C/U
1041434	505 CAJON	10	C/U
1041435	506 PUERTA BATIENTE DER	10	C/U
1041436	507 PUERTA BATIENTE IZQ	10	C/U
1041437	511 CAJON	10	C/U
1041438	512 PUERTA BATIENTE DER	10	C/U
1041439	513 PUERTA BATIENTE IZQ	10	C/U
1041440	611 CAJON PASANTE	10	C/U
1041441	612 CAJON PASANTE	10	C/U
1041450	710 25MM	10	C/U
1041455	811 GAVETA	10	C/U
1041456	812 PUERTA DE GAVETA DER	10	C/U
1041457	813 PUERTA DE GAVETA IZQ	10	C/U
1041460	821 GAVETA	10	C/U
1041461	822 PUERTA DE GAVETA DER	10	C/U
1041462	823 PUERTA DE GAVETA IZQ	10	C/U
1041465	831 GAVETA	10	C/U
1041466	832 PUERTA DE GAVETA DER	10	C/U
1041467	833 PUERTA DE GAVETA IZQ	10	C/U



120

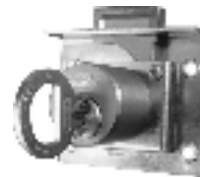

325



512



710



821

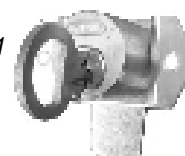

ACCESORIOS Y OPCIONALES

Código	Descripción	X Caja	U.M.
1041301	LLAVE 3 COMBINAC.	100	C/U
1041302	LLAVE 4 COMBINAC.	100	C/U
1041303	LLAVE 5 COMBINAC.	100	C/U
1041304	ROSETA BRONCEADA	100	C/U
1041305	ROSETA PLATIL	100	C/U
1041309	TUBO P/ 710	100	C/U
1041310	CONTRAFRENTE	100	C/U
1041306	RECARGO PLATIL	1	C/U
1041308	RECARGO COMBINADO	1	C/U



CERRADURAS EVERGOOD



Código	Descripción	Xcaja	U.M.
CERRADURAS DE EMPUJE			
9110101	ART. 105 CROMO P/CORREDIZA	40	C/U
9110102	ART. 105 ORO P/CORREDIZA	40	C/U
CERRADURAS DE APLICAR			
CILINDRO 22 MM			
9110105	ART. 106 CROMO BASE ROMBO	25	C/U
9110106	ART. 106 ORO BASE ROMBO	25	C/U
CILINDRO 19 MM			
9110110	ART. 109 CROMO BASE REDONDA	30	C/U
9110111	ART. 109 ORO BASE REDONDA	30	C/U
9110112	ART. 138 BASE CUADRADA	30	C/U
CERRADURAS PARA CAJONERAS			
9110114	ART. 208 CROMO LATERAL C/VAR.	24	C/U
9110113	ART. 298 FRONTAL C/VARILLA	24	C/U
CERRADURAS PARA VITRINAS			
PARA VITRINA CORREDIZA			
9110115	ART. 220 CROMO SERRUCHO VITRINA	25	C/U
PARA VIDRIO BATIENTE			
9110120	ART. 238 VIDRIO SIMPLE	12	C/U
9110121	ART. 248 VIDRIO DOBLE	20	C/U
CERRADURAS PARA PUERTAS METALICAS			
9110125	ART. 312 ROSCADA C/LLAVIN	40	C/U
9110130	ART. 102-20 MM ROSCADA C/LLAVE	40	C/U
9110131	ART. 102-30 MM ROSCADA C/LLAVE	30	C/U

OBS: CONSULTAR POR CERRADURAS COMBINADAS



105



106



109



138



208



298



220



238



312



248



102

CANDADOS DOBLE PALETA ACYTRA

Código	Descripción	X Caja	U.M.
1050401	906 - 40 MM	12	C/U
1050402	901 - 55 MM	12	C/U
1050403	913 - 70 MM	6	C/U
1050405	40 MM CON CADENA	1	C/U
1050406	40 MM ARO LARGO	1	C/U
1050407	55 MM CON CADENA	1	C/U
1050409	70 MM CON CADENA	1	C/U

OBS. CADENA FORRADA EN PVC TRANSLUCIDO



CANDADOS DOBLE PALETA ROA

Código	Descripción	X Caja	U.M.
1250101	40 MM.	12	C/U
1250102	50 MM	12	C/U



CANDADOS DOBLE PALETA PRIVE

Código	Descripción	X Caja	U.M.
1090516	50 MM	22	C/U
1090517	50 MM.ARO LARGO	1	C/U
1090518	50 MM C/LINGA 70 CM	1	C/U
10905180	50 MM C/LINGA 100 CM	1	C/U
10905181	50 MM C/LINGA 120 CM	1	C/U

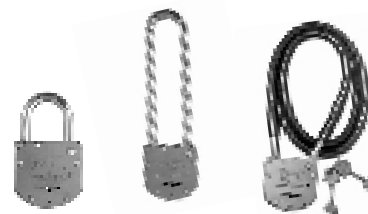

CANDADOS COMPUTADOS LOCK 6

Código	Descripción	X Caja	U.M.
3710101	CY1-40 MM	1	C/U
3710102	CY2-50 MM	1	C/U
3710106	CY3-60 MM	1	C/U
3710107	CY4-70 MM	1	C/U
3710120	CY7 A 50 MM ARO LARGO	1	C/U
3710121	CY3 A 60 MM ARO LARGO	1	C/U
3710122	CY4 A 70 MM ARO LARGO	1	C/U

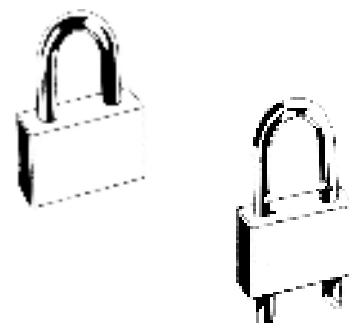

CANDADOS BLINDADOS TRABEX

Código	Descripción	X Caja	U.M.
1110403	MEDIANO ABERTURA 20 MM	12	C/U
1110404	GRANDE ABERTURA 30 MM	12	C/U
1110402	MEDIANO AUTOMATICO	12	C/U

Ver
portacandados en
pag.:90-92-105



CANDADOS BRONCE PRIVE

Código	Descripción	X Caja	U.M.
1090501	25 MM DOBLE TRABA	12	C/U
1090502	30 MM DOBLE TRABA	12	C/U
1090503	40 MM DOBLE TRABA	12	C/U
1090504	50 MM DOBLE TRABA	6	C/U
1090505	60 MM DOBLE TRABA	6	C/U
1090510	30 MM DOBLE TRABA ARO LARGO	12	C/U
1090511	40 MM DOBLE TRABA ARO LARGO	12	C/U
1090515	30 MM COMBINACION NUMERICA	12	C/U



CANDADOS BRONCE M H A



Código	Descripción	X Caja	U.M.
9080101	20 MM.	12	C/U
9080102	25 MM.	12	C/U
9080103	30 MM.	12	C/U
9080104	40 MM.	12	C/U
9080105	50 MM.	6	C/U
9080106	60 MM.	6	C/U
9080110	25 MM = COMBINACION	12	C/U
9080111	30 MM = COMBINACION	12	C/U
9080112	40 MM = COMBINACION	12	C/U
9080113	50 MM = COMBINACION	6	C/U
9080114	60 MM = COMBINACION	6	C/U
9080120	70 MM BLINDADO	6	C/U
9080121	90 MM BLINDADO	6	C/U
9080130	PARA MOTO 80x250	1	C/U
9080131	PARA MOTO 110X300		



OBS: PRODUCTO DISCONTINUADO, CONSULTAR DISPONIBILIDAD.

CANDADOS IFAM



Código	Descripción	X Caja	U.M.
CANDADOS DE BRONCE			
9140101	BRONCE 20 MM "TIFON"	12	C/U
9140102	BRONCE 25 MM "TIFON"	12	C/U
9140103	BRONCE 30 MM "TIFON"	12	C/U
9140104	BRONCE 40 MM "TIFON"	12	C/U
9140105	BRONCE 50 MM "TIFON"	6	C/U
9140106	BRONCE 60 MM "TIFON"	6	C/U
9140120	BRONCE 30 MM COMB NUMERICA	12	C/U
9140121	BRONCE 40 MM COMB NUMERICA	12	C/U
CANDADOS INOXIDABLES			
9140130	CROMADO 30 MM	12	C/U
9140131	CROMADO 40 MM	12	C/U
9140132	CROMADO 50 MM	6	C/U
CANDADOS PARA INTEMPERIE			
9140170	CANDADO WP45	6	C/U





CANDADOS BLINADADOS IFAM

Código	Descripción	X Caja	U.M.
9140150	70 MM BRONCE	6	C/U
9140151	90 MM BRONCE	6	C/U
9140160	60 MM SUPER BLINDADO	6	C/U
9140161	80 MM SUPER BLINDADO	6	C/U
9140162	90 MM SUPER BLINDADO	6	C/U



CANDADOS DE BRONCE ANCHOR

Código	Descripción	X Caja	U.M.
2127130	20 MM BRONCE	12	C/U
2127131	25 MM BRONCE	12	C/U
2127132	30 MM BRONCE	12	C/U
2127133	40 MM BRONCE	12	C/U
2127134	50 MM BRONCE	6	C/U
2127135	60 MM BRONCE	6	C/U



CANDADOS DE BRONCE BLACK & DEKER

Código	Descripción	X Caja	U.M.
1030101	20 MM	12	C/U
1030102	25 MM	12	C/U
1030103	30 MM	12	C/U
1030104	40 MM	12	C/U
1030105	50 MM	6	C/U
1030106	60 MM	6	C/U
1030107	70 MM	6	C/U
1030201	ARO LARGO 30 MM	12	C/U
1030202	ARO LARGO 40 MM	12	C/U



CANDADOS HORIZONTALES

1030301	CANDADO B&D PER.HOR 50 MM	6	C/U
1030302	CANDADO B&D PER.HOR 70 MM	6	C/U
1030303	CANDADO B&D BLINDADO 60 MM	6	C/U



CANDADOS CROMADOS

1030401	CANDADO B&D 30 MM	6	C/U
1030402	CANDADO B&D 40 MM	6	C/U
1030403	CANDADO B&D 60 MM	6	C/U
1030501	CANDADO B&D ARO LARGO 30 MM	6	C/U
1030502	CANDADO B&D ARO LARGO 40 MM	6	C/U



CANDADOS NUMERICOS

1030601	CANDADO B&D 30 MM NUMERICO	6	C/U
1030602	CANDADO B&D 40 MM NUMERICO	6	C/U

Ver portacandados en pag.:90-92-105

CANDADOS PARA TRANQUERA

Código	Descripción	X Caja	U.M.
1990101	CANDADO PERITA GRANDE	1	C/U
1990102	CANDADO PERITA CHICO	1	C/U
1990103	CANDADO PERITA RECTO	1	C/U



CANDADOS USOS VARIOS

Código	Descripción	X Caja	U.M.
1041202	CANDADO PARA DISCO TELEFONICO	10	C/U
1041250	CANDADO PARA VALIJA	10	C/U



LLAVES DOBLE PALETA

Código	Descripción		
1500101	N:001 ACYTRA	1501102	N:061 COMBIN. 1 FINA
1500102	N:002 TRABEX GRANDE	1501104	N:071 MUEBLE 1
1500103	N:003 TRABEX CHICA	1501201	N:072 MUEBLE 2
1500104	N:004 PRIVE 200	1501202	N:073 MUEBLE 3
1500105	N:005 VANDOS ANT/GDE	1501203	N:074 MUEBLE 0 CORTA
1500106	N:006 VANDOS NVA/GDE	1501204	N:075 MUEBLE 0 LARGA
1500107	N:007 BERTOLO VIEJA	1501206	N:081 C/FUER. 10H
1500108	N:008 GIACO	1501207	N:082 C/FUER. 10M
1500201	N:009 TEACHE CHICA	1501208	N:083 C/FUER. 9H
1500202	N:010 AN-DIF LARGA	1501301	N:084 C/FUER. 9M
1500203	N:011 CANDEX GRANDE	1501305	N:088 C/FUER. 9M LGA.
1500204	N:012 KALLAY GRANDE	1501401	N:089 C/FUER. 13H
1500205	N:013 KALLAY ANT/CHIC.	1501402	N:090 C/FUER. 13M
1500206	N:014 CANDEX MEDIANA	1501801	N:091 C/FUER. 14H
1500207	N:015 CANDEX CHICA	1501803	N:092 C/FUER. 14M
1500208	N:016 VANDOS 501	1501811	N:101 ACYTRA LARGA
1500209	N:017 CANDEX 117	1501813	N:102 TRABEX GDE/LGA.
1500301	N:018 VANDOS PLAC/NV.	1501815	N:103 TRABEX CHIC/LGA.
1500302	N:019 VANDOS PLAC/VIE	1501817	N:104 CANDEX 109
1500303	N:020 ACYTRA PLACARD	1501819	N:105 CANDEX SUP/LGA.
1500305	N:021 AN-DIF CHICA	1501821	N:106 CANDEX 113
1500401	N:022 AN-DIF BLINDEX	1501823	N:107 CANDEX 110
1500402	N:023 PRIVE GRANDE	1501825	N:108 TRABEX CORTINA
1500403	N:024 HH BLINDEX	1501827	N:109 VANDOS NVA/LGA
1500404	N:025 MICRON EVERLOK	1501829	N:110 PALENQUE LARGA
1500405	N:026 EYRO (ROI) 999	1501831	N:111 AN-DIF BLIND/LGA.
1500406	N:027 CATALANO	1501833	N:112 ROI 777
1500407	N:028 AN-DIF CORTA	1501835	N:113 ROI 2000
1500408	N:029 KALLAY MEDIANA	1501836	N:114 ARTICULADA
1500501	N:030 TRAN-K	1501837	N:115 FICHET
1500502	N:031 LUBER 1001	1501838	N:116 8 BLOQ
1500503	N:032 ELEFANTE	1501839	N:117 8 BLOQ LARGA
1500504	N:033 G.H.	1501840	N:118 ROA FLIAR. LGA.
1500505	N:034 BOXER	1501842	N:119 MAC CONS. LGA.
1500506	N:035 ACORAZADO	1501843	N:120 PRIVE 200 LGA.
1500601	N:036 TREBOL	1501845	N:121 TRABEX MIG/LGA.
1500701	N:037 PALENQUE	1501846	N:122 8 BLOQ BLINDEX
1500702	N:038 JAQUE	1501847	N:123 ROA CONS. LGA.
1500801	N:039 BERTOLO NUEVA	1501849	N:124 ROA GRDE. LGA.
1500802	N:040 PRIVE MIGNON	1501850	N:125 KALLAY 4000 LGA.
1500803	N:041 PICCOLINA	1501852	N:126 KALLAY 4007 LGA.
1500804	N:042 STAR GRANDE	1501902	N:150 TRABEX MIGNON
1500805	N:043 MAYA	1501903	N:151 M Y M CANDADO
1500806	N:044 D.A.C.	1501904	N:152 VANDOS CAND/CH
1500901	N:045 R.C.	1501905	N:153 CANDEX 119
1500902	N:046 KALLAY MIGNON	1501906	N:154 ROA GRANDE
1500903	N:047 TEACHE 400	1501907	N:155 ROI 995
1500904	N:048 ROA CANDADO	1501908	N:156 ACYTRA CAND/CH
1500905	N:049 JOWILL	1501909	N:157 PRANTY
1500906	N:050 ACYTRA CANDAD.	1501910	N:158 EXPAL GRANDE
1501001	N:051 PICCOLO FINA	1501911	N:159 EXPAL CHICA
1501002	N:052 PICCOLO 0 MED.	1501912	N:160 STAR CHICA
1501003	N:053 COMBINACION 1	1501913	N:161 BOCC
1501004	N:054 COMBINACION 2	1501914	N:162 YAVER (TABOR)
1501005	N:055 0 FINA	1501915	N:163 ZF CHICA
1501006	N:056 2 LARGA GRUESA	1501916	N:164 AN-DIF 101
1501007	N:057 00 MEDIANA	1501917	N:165 ROA PLANA FLIAR.
1501008	N:058 0 MEDIANA LARGA	1501918	N:166 LUBER 1025
1501009	N:059 COMBIN. 2 LARGA	1501919	N:167 MAC CONSORCIO
		1501920	N:168 MAC FAMILIAR

Bolsas de
25 uds.

1501921	N:169 VANDOS CAND/CH	1503005	N:191 TRABEX 3101
1501922	N:170 ROA PLACARD	1503006	N:192 DUTTO
1501923	N:171 LLAVEX	1503009	N:193 ANUAC DOB-PALETA
1502001	N:172 ROA PLANA/CONS	1503010	N:194 CANDEX X124
1502002	N:173 P.M.P.	1503013	N:195 TRABEX X CANDADO
1502003	N:174 STAR CERROJO	1503015	N:196 DIVO
1502004	N:175 EXPAL MEDIANA	1503016	N:197 GEMA
1502005	N:176 ROA 118/9	1503017	N:198 BUNKER
1502006	N:177 KALLAY 4000	1503018	N:199 TREBOL CHICA
1502007	N:178 KALLAY 4007 PLANA	1503019	N: 200 CERRATEX
1502010	N:179 ZF MEDIANA	1503020	N: 201 CANDEX 126
1502101	N:180 PRIVE CANDADO		
1502102	N:181 ACYTRA PLANA		
1502103	N:182 R.C. SIN FRESAR		
1502104	N:183 ACYTRA MEDIANA		
1502105	N:184 SECUREME CHICA		
1502301	N:185 CIERRASOLA		
1502302	N:186 SECUREME LARGA		
1502305	N:187 ACYTRA 184		
1502306	N:188 ACYTRA CON TOPE		
1503001	N:189 ROA 111/		
1503003	N:190 TRABEX 600		



NUECES Y PESTILLOS

Código	Descripción	U.M.
1503022	301 PEST/TRABEX 6624	1 C/U
1503024	302 PEST/TRABEX 2105	1 C/U
1503101	303 PEST/TRABEX 1025	1 C/U
1503102	305 PEST/TEACHE 302	1 C/U
1503103	307 PEST/CANDEX GDE. 111 - 118	1 C/U
1503105	308 PEST/CANDEX 114	1 C/U
1503106	309 PEST/CANDEX 117	1 C/U
1503107	310 PEST/CANDEX CHCA 115 - 116	1 C/U
1503108	311 PEST/TEACHE 400	1 C/U
1503109	312 PEST/ACYTRA 101	1 C/U
1503112	351 NUEZ ACYTRA 101	1 C/U
1503114	352 NUEZ PRIVE 200	1 C/U
1503115	353 NUEZ CANDEX 115 - 116	1 C/U
1503118	354 NUEZ CANDEX 114	1 C/U
1503119	355 NUEZ CANDEX 117	1 C/U
1503121	356 NUEZ CANDEX 111	1 C/U
1503122	357 NUEZ CANDEX 118	1 C/U
1503124	359 NUEZ TEACHE 302	1 C/U
1503125	360 NUEZ TEACHE 400	1 C/U
1503126	363 NUEZ TRABEX GDE. 2105	1 C/U
1503127	364 NUEZ TRABEX CHCA 6624	1 C/U
1503128	365 NUEZ TRABEX MIGN. 1020125	1 C/U
1503130	366 NUEZ KALLAY 2001	1 C/U
1503149	367 NUEZ KALLAY 501	1 C/U
1500201	368 NUEZ KALLAY 4001	1 C/U
1500202	369 NUEZ KALLAY 503 - 4005	1 C/U

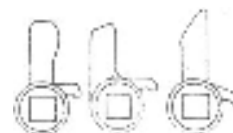

AROS PARA LLAVES/LLAVEROS			
Código	Descripción	xbolsa	U.M.
1200101	ARO SIN FIN 15 MM. x 1000	0.5	MIL
1200103	ARO SIN FIN 20 MM. x 1000	0.5	MIL
1200105	ARO SIN FIN 25 MM. x1000	0.5	MIL
1200107	ARO SIN FIN 30 MM. x 1000	0.5	MIL
1200109	ARO SIN FIN 45 MM. x 1000	0.5	MIL
1200125	LLAVERO PVC COLOR	200	C/U



LLAVES YALE Y AUTO				TABOR
Código	Descripción	xcaja	U.M.	
1370401	LLAVE TABOR YALE CILINDRO	50	C/U	
1370402	LLAVE TABOR YALE 15D	50	C/U	
1370403	LLAVE TABOR YALE 15 JOWIL	50	C/U	
1370404	LLAVE TABOR YALE ESTEPA	50	C/U	
1370405	LLAVE TABOR YALE FICHET	50	C/U	
1370406	LLAVE TABOR PERA CHICA	50	C/U	
1370407	LLAVE TABOR PERA GRANDE	50	C/U	
1370408	LLAVE TABOR 8 DER PTO COLOR	50	C/U	
1370409	LLAVE TABOR DIAGONAL	50	C/U	
1370501	LLAVE TABOR VANGUARD A-B-C-L-	50	C/U	
1370502	LLAVE TABOR C.SOLA B LAPS	50	C/U	
1370503	LLAVE TABOR LOCK 6 C/PTOS	50	C/U	
1370504	LLAVE TABOR TX COMPUTADA	50	C/U	
1370505	LLAVE TABOR VANGUARD S/P	50	C/U	
1370506	LLAVE TABOR LOCK 6	50	C/U	
1370507	LLAVE TABOR PRIVE COMPUT	50	C/U	
1370508	LLAVE TABOR YALTRES CANDADO	50	C/U	
1370509	LLAVE TABOR YALTRES 606CE	50	C/U	
1370510	LLAVE TABOR YALTRES 606CE L	50	C/U	
1370511	LLAVE TABOR BULIT COMP	50	C/U	
1370512	LLAVE TABOR ABLOY	50	C/U	
1370513	LLAVE TABOR YALTRES USA	50	C/U	
1370514	LLAVE TABOR YALTRES LARGA	50	C/U	
1370515	LLAVE TABOR USA CONSORCIO	50	C/U	
1370516	LLAVE TABOR MULTITRACK	50	C/U	
1370517	LLAVE TABOR KALLAY 2100 LAPS	50	C/U	
1370518	LLAVE TABOR ACYTRA MARA	50	C/U	
1370519	LLAVE TABOR CANDEX 2000	50	C/U	
1370520	LLAVE TABOR KALLAY 2100C	50	C/U	
1370521	LLAVE TABOR DELL AVO	50	C/U	
1370522	LLAVE TABOR PFW CILI C40	50	C/U	
1370523	LLAVE TABOR 606 FRESADA	50	C/U	
1370524	LLAVE TABOR LOCK 6 RANURADA	50	C/U	
1370525	LLAVE TABOR MTL 7	50	C/U	
1370526	LLAVE TABOR MTL 6	50	C/U	
1370601	LLAVE TABOR BASH D/I	50	C/U	
1370602	LLAVE TABOR MOSLER	50	C/U	
1370603	LLAVE TABOR SHARER	50	C/U	
1370604	LLAVE TABOR SEG BANCO	50	C/U	
1370701	LLAVE TABOR CRUZ YAL LARGA	50	C/U	
1370702	LLAVE TABOR CRUZ YAL MED.	50	C/U	
1370703	LLAVE TABOR CRUZ YAL CORTA	50	C/U	

1370704	LLAVE TAVOR CRUZ YAL EX LARG	50	C/U
1370705	LLAVE TAVOR CRUZ PRIVE	50	C/U
1370706	LLAVE TAVOR CRUZ TRABA VOL	50	C/U
1370801	LLAVE TAVOR AUTO METAL	50	C/U
1370802	LLAVE TAVOR AUTO R12 91 LARG	50	C/U
1370803	LLAVE TAVOR AUTO PLASTICA	50	C/U
1370804	LLAVE TAVOR AUTO FORD PICK U	50	C/U
1370805	LLAVE TAVOR AUTO POLO MAPA	50	C/U
1370806	LLAVE TAVOR PALIO/FIESTA VACI	50	C/U
1370807	LLAVE TAVOR AUTO RANGER/EXP	50	C/U
1370808	LLAVE TAVOR RANGER AUXILIO	50	C/U
1370809	LLAVE TAVOR AUTO FIESTA	50	C/U
1370810	LLAVE TAVOR AUTO CITR/PEUGE	50	C/U
1370811	LLAVE TAVOR AUTO INSERTO C 3	50	C/U
1370812	LLAVE TAVOR AUTO INSERTO 307	50	C/U
1370813	LLAVE TAVOR AUTO INSERTO 407	50	C/U
1370901	LLAVE TAVOR MOTO PLASTICA	50	C/U
1370902	LLAVE TAVOR MOTO METALICA	50	C/U
1370903	LLAVE TAVOR MOTO HONDA LARG	50	C/U



SOLICITE CATALOGO COMPLETO

LLAVES ORIGINALES YALTRES-CIERRASOLA

Código	Descripción	U.M.	
LLAVES CRUZ			
1140502	CORTA 40 MM	1	C/U
1140501	MEDIANA 55 MM	1	C/U
1140500	LARGA 70 MM (6LE)	1	C/U
1140503	EXTRA LARGA 85 MM	1	C/U
LLAVES COMPUTADAS			
11405140	YALTRES "USA" 5 PERNOS	50	C/U
1330211	CIERRASOLA "C"	50	C/U



ALDABAS DE HIERRO

Código	Descripción	X Caja	U.M.
2410500	"PATITO" CINCADA DER	100	C/U
2410501	"PATITO" CINCADA IZQ	100	C/U
2410504	PUENTE SOLO	100	C/U

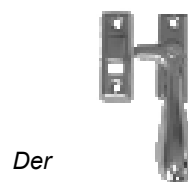

ALDABAS DE BRONCE

Código		Descripción	X Caja	U.M.
DER	IZQ			
2491501	2491502	MINISTERIO BR PULIDO	10	C/U
24915010	24915020	MINISTERIO BR PLATIL	10	C/U
2400701	2400702	MINI BR PULIDO	25	C/U
2400703	2400704	MINI BR PLATIL	25	C/U
2400705	2400706	MEDIANA BR PULIDO	25	C/U
2400707	2400708	MEDIANA BR PLATIL	25	C/U
2400710	2400711	RECTA BR PULIDO	25	C/U
2400712	2400713	RECTA BR PLATIL	25	C/U
2491601	2491602	MEDIALUNA BR PULIDO	10	C/U
24916010	24916020	MEDIALUNA BR PLATIL	10	C/U
2491603	2491604	REGULABLE BR PULIDO	24	C/U
24916030	24916040	REGULABLE BR PLATIL	24	C/U
2491605		TIPO PUENTE BRONCE PULIDO	24	C/U
24916050		TIPO PUENTE BRONCE PLATIL	24	C/U
2125901		REVERSIBLE BRONCE PUL. LACA	12	C/U

herbron

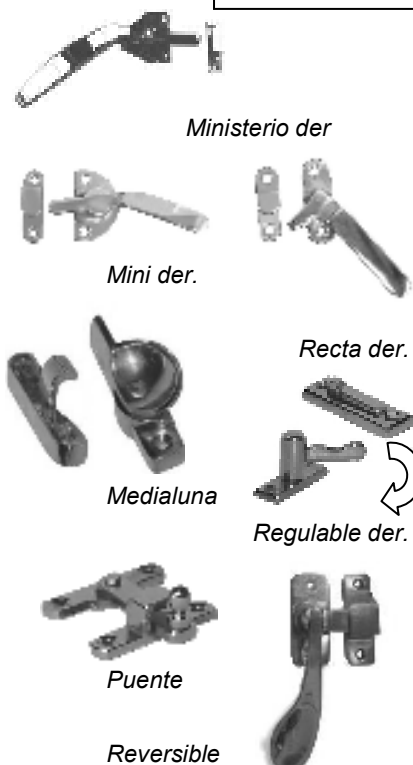

CIERRE DE APLICAR PARA VENTANA CORREDIZA

Código	Descripción	X Caja	U.M.
CIERRES DE BRONCE			
DER	IZQ		
2400401	2400402	FRONTAL BR PULIDO	25 C/U
2400405	2400406	FRONTAL BR PLATIL	25 C/U
2400403	2400404	LATERAL BR PULIDO	25 C/U
2400407	2400408	LATERAL BR PLATIL	25 C/U
2400415	2400416	SOLO BR PULIDO	25 C/U
2400417	2400418	SOLO BR PLATIL	25 C/U
ACCESORIOS			
2400410		PUENTE FRONTAL BR PULIDO	25 C/U
2400411		PUENTE FRONTAL BR PLATIL	25 C/U
2400412		PUENTE LATERAL BR PULIDO	25 C/U
2400413		PUENTE LATERAL BR PLATIL	25 C/U
CIERRES DE HIERRO BRONCEADO			
DER	IZQ		
2010101	2010102	CON PUENTE FRONTAL	50 C/U
2010003	2010004	CON PUENTE LATERAL	50 C/U
2010001	2010002	SOLO, SIN PUENTE	50 C/U

herbron

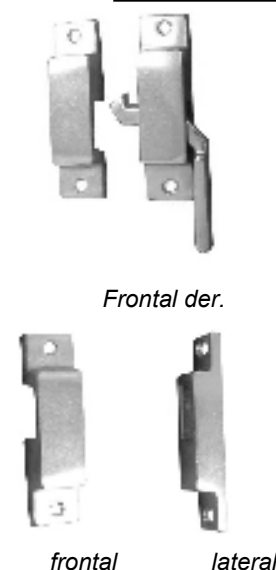

CIERRE PARA VENTANA CORREDIZA TIPO "COLECTIVO"

Código	Descripción	X Caja	U.M.
2020901	CINCADO CON PUENTE LATERAL	20	C/U
2020902	CINCADO CON PUENTE FRONTAL	20	C/U



frontal

CIERRE DE EMBUTIR TIPO CUBETA

Codigo	Descripcion	X Caja	U.M.
--------	-------------	--------	------

CIERRES DE HIERRO BRONCEADO

DER	IZQ		X Caja	U.M.
2010219	2010220	CIERRE DE EMBUTIR	50	C/U

CIERRES DE BRONCE C/ENGANCHE

DER	IZQ		X Caja	U.M.
2400420	2400421	BRONCE PULIDO	25	C/U
2400422	2400423	BRONCE PLATIL	25	C/U
2400427		CONTRAFRETE CINC.AMARILLO		

CUBETAS

2400509	CUBETA C/BOCA BR PULIDO	25	C/U
24005090	CUBETA S/BOCA BR PULIDO	25	C/U
24005091	CUBETA C/BOCA BR PLATIL	25	C/U
24005092	CUBETA S/BOCA BR PLATIL	25	C/U

CIERRES DE BRONCE C/VASTAGO 1/4"

DER	IZQ		X Caja	U.M.
2431701	2431702	BRONCE PULIDO	12	C/U
2431703	2431704	BRONCE PLATIL	12	C/U

CUBETAS

2431707	CUBETA C/BOCA BR PULIDO	12	C/U
2431706	CUBETA S/BOCA BR PULIDO	12	C/U
24317070	CUBETA C/BOCA BR PLATIL	12	C/U
24317060	CUBETA S/BOCA BR PLATIL	12	C/U

CIERRES DE ACERO

DER	IZQ		X Caja	U.M.
3260101	32601010	TIPO "PAMETALICA"	2	C/U

herbron



Der.



Izq.



CIERRE DE CENTRO

Código	Descripción	X Caja	U.M.
--------	-------------	--------	------

CIERRES CENTRALES DE BRONCE

PULIDO	PLATIL		X Caja	U.M.
2434501	24345010	POMO 25 MM	12	C/U
2434503	24345030	POMO 30 MM C/TRABA	12	C/U
2093054	2093055	POMO 30- 2"	6	C/U

CIERRES CENTRALES PLASTICOS

2410801	PLASTICO NEGRO	24	C/U
2410802	PLASTICO DORADO	24	C/U
2410803	PLASTICO CROMO	24	C/U



25 mm

30 mm

c/traba

plastico

CIERRES PARA CARPINTERIA DE ALUMINIO

Código	Descripción	X Caja	U.M.
2410740	CIERRE A PALANCA NEGRO	20	C/U
2410741	CIERRE A PALANCA BLANCO	20	C/U
2500252	CIERRE NIQUELADO TIPO "9"	24	C/U
2410750	ALDABA CP 5 NEGRA	12	C/U
2410748	ALDABA CP 7 NEGRA	12	C/U

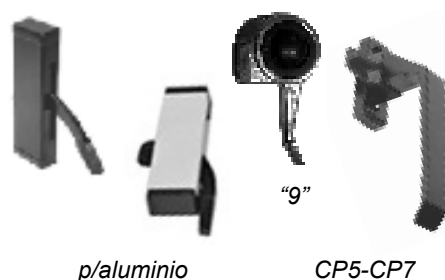

p/aluminio

CP5-CP7

CIERRE PARA VENTANA GUILLOTINA

Código	Descripción	X Caja	U.M.
PULIDO	PLATIL		
2401001	24010010 BRONCE, GRANDE	15	C/U
2401004	24010040 BRONCE, CHICO	15	C/U
2401002	24010020 PUENTE SOLO	1	C/U

OBS.: SE PROVEE CON DOS PUENTES

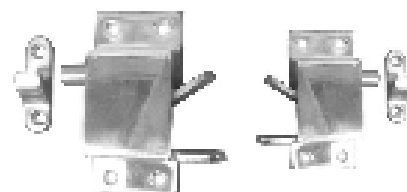

CIERRE VIGILANTE A CADENA

Código	Descripción	X Caja	U.M.
9043015	BRONCE PULIDO CON LACA	20	C/U
9043016	BRONCE CROMADO	20	C/U



CIERRE VIGILANTE

Código	Descripción	X Caja	U.M.
2492102	COMUN BRONCE PULIDO	6	C/U
2492132	COMUN BRONCE PLATIL	6	C/U
2492101	CON TRABA BR.PULIDO	6	C/U
2492131	CON TRABA BR.PLATIL	6	C/U
1110305	VIGILANTE "BLOQUEO" TRABEX	1	C/U

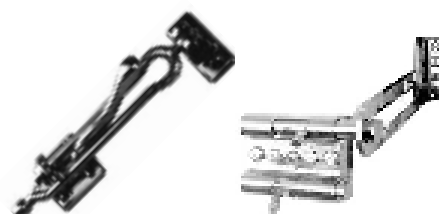

vigilante

"bloqueo"

CIERRE A CREMALLERA

Código	Descripción	X Caja	U.M.
2433601	1" BRONCE PULIDO	12	C/U
24336010	1" BRONCE PLATIL	12	C/U
2433602	1.5" BRONCE PULIDO	12	C/U
24336020	1.5" BRONCE PLATIL	12	C/U
2433603	2" BRONCE PULIDO	12	C/U
24336030	2" BRONCE PLATIL	12	C/U



CIERRE PARA PUERTA DE GAS

Código	Descripción	X Caja	U.M.
2080701	DE CHAPA CINCADE C/LLAVIN	50	C/U
2080702	DE CHAPA CINCADE SOLO	50	C/U
2080703	LLAVIN CINCADE	50	C/U
3010225	TORNEADO 16 MM	50	C/U
3010226	TORNEADO 25MM	50	C/U
3010227	TORNEADO 32 MM	50	C/U



CIERRE PARA PUERTA CASA RODANTE

Código	Descripción	X Caja	U.M.
1281402	TIPO "EGRO" BRONCE PULIDO	10	C/U
1281403	TIPO "EGRO" BRONCE PLATIL	10	C/U



TRABAS PARA CORTINA DE ENROLLAR

Código	Descripción	X Caja	U.M.
PARA CORTINA BARRIO			
3380102	"CORVEX"	12	JGO
PARA CORTINA COMUN			
3380101	"CORVEX"	12	JGO
1110405	"PERSIGUR". 27MM.	25	JGO
1110406	"PERSIGUR". 35MM.	25	JGO
1110407	"PERSIGUR". 90MM.	25	JGO

OBS.: *CORVEX: VA AL MARCO, SE COMPONE DE DOS PIEZAS
 *PERSIGUR: COMPUESTO POR UN PERNO, UNA PLANCHUELA DE FIJACION A LA PERSIANA Y OTRA PARA EL MARCO

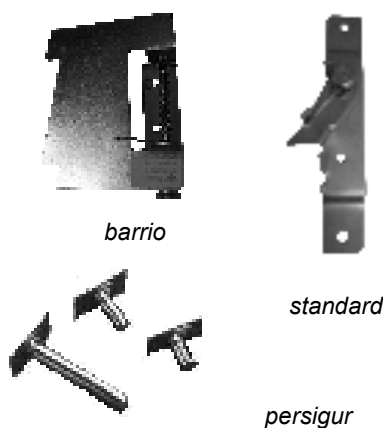

RETENES A PRESION PARA PUERTAS

Código	Descripción	X Caja	U.M.
BRONCE ESTAMPADO			
2432510	AL PISO BRONCE PULIDO	12	C/U
24325100	AL PISO BRONCE PLATIL	12	C/U
2432511	AL ZOCALO BRONCE PULIDO	12	C/U
24325110	AL ZOCALO BRONCE PLATIL	12	C/U
BRONCE FUNDIDO			
2493001	AL PISO BRONCE PULIDO	12	C/U
2493031	AL PISO BRONCE PLATIL	12	C/U
2493002	AL ZOCALO BRONCE PULIDO	12	C/U
2493032	AL ZOCALO BRONCE PLATIL	12	C/U
DE PLASTICO			
3380404	AL PISO	12	C/U
3380406	AL ZOCALO (PARED)	12	C/U

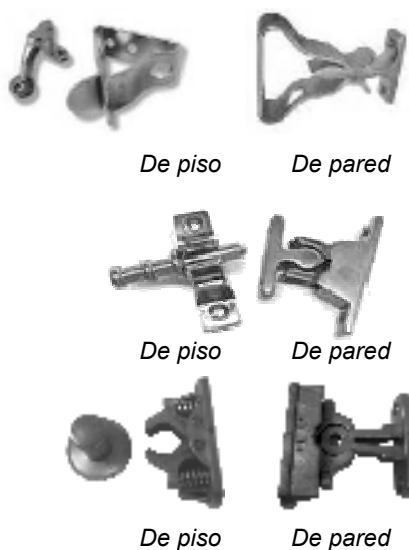

RETENES PARA PTA VARIOS

Código	Descripción	X Caja	U.M.
2432504	TIPO ATLAS ACERO	12	C/U
2432501	TIPO ATLAS BRONCE	12	C/U
2432506	"STRABAPLUS" BRONCE PULIDO	6	C/U
2432507	"STRABAPLUS" BRONCE PLATIL	6	C/U

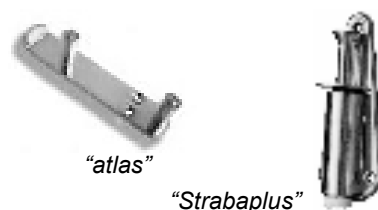

TRABA PARA PORTON

Código	Descripción	X Caja	U.M.
2021007	TRABA PORTON CORREDIZO	24	C/U

OBS.: HIERRO CINCADO



RETENES PARA POSTIGON

Código	Descripción	X Caja	U.M.
4021520	P/TACO N´10 – 90 MM CINCADO	1	DOC
4021521	P/TACO N´10 – 120 MM CINCADO	1	DOC
4021522	P/TACO N´10 – 160 MM CINCADO	1	DOC
4021534	P/TACO N´10 – 90 MM NEGR. Y DOR	1	X6
4021535	P/TACO N´10 – 120 MM NEGR.Y DOR	1	X6
4021536	P/TACO N´10 – 160 MM NEGR.Y DOR	1	X6



BRAZOS DE EMPUJE HIERRO CINCADO

Código		Descripción	X Caja	U.M.
AZUL	AMARILLO			
2021501	2021510	20 CM.MADERA	20	C/U
20215010	20215100	20 CM METAL	20	C/U
2021502	2021511	25 CM.MADERA	20	C/U
20215020	20215110	25 CM METAL	20	C/U
2021503	2021512	30 CM.MADERA	20	C/U
20215030	20215120	30 CM.METAL	20	C/U
2021504	2021513	35 CM MADERA	20	C/U
20215040	20215130	35 CM METAL	20	C/U
2021505	2021514	40 CM.MADERA	20	C/U
20215050	20215140	40 CM METAL	20	C/U
2021507	2021517	50 CM MADERA	20	C/U
20215070	20215170	50 CM METAL	20	C/U



Para madera



Para metal

BRAZOS DE EMPUJE DE BRONCE

Código		Descripción	X Caja	U.M.
PULIDO	PLATIL			
2291001	2291008	20 CM.MADERA	6	C/U
22910010	22910080	20 CM.METAL	6	C/U
2291002	2291009	25 CM.MADERA	6	C/U
22910020	22910090	25 CM.METAL	6	C/U
2291003	2291010	30 CM.MADERA	6	C/U
22910030	22910100	30 CM.METAL	6	C/U
2291004	2291011	35 CM.MADERA	6	C/U
22910040	22910110	35 CM.METAL	6	C/U



ACCESORIOS P/BRAZOS DE EMPUJE

Código		Descripción	X Caja	U.M.
PULIDO	PLATIL			
2291013	22910130	TRABA BRONCE	1	C/U
2291012	22910120	GUIA BRONCE	1	C/U
2291014	22910140	PUNTERA P/MADERA	1	C/U
2291015	22910150	PUNTERA P/METAL	1	C/U



Traba

Guía



madera

metal

VAIVENES A RODILLO

Código	Descripción	X Caja	U.M.
1281301	SEB 50 MM.CINCADO.	10	C/U
1281302	SEB 50 MM.BCE.PULIDO	10	C/U
1281303	SEB 50 MM.BCE.PLATIL	10	C/U
1281304	SEB 120 MM.CINCADO.	10	C/U
1281305	SEB 120 MM.BCE.PULIDO	10	C/U
1281306	SEB 120 MM.BCE.PLATIL	10	C/U
1101221	KALLAY 5023 FTE NIQUELADO	1	C/U
1101222	KALLAY 5023 FTE BRONCEADO	1	C/U
1101223	KALLAY 5023 FTE BRONCE	1	C/U
1101224	KALLAY 5023 FTE BCE.PLATIL	1	C/U

OBS.: LA MEDIDA CORRESPONDE AL LARGO DEL FRENTE

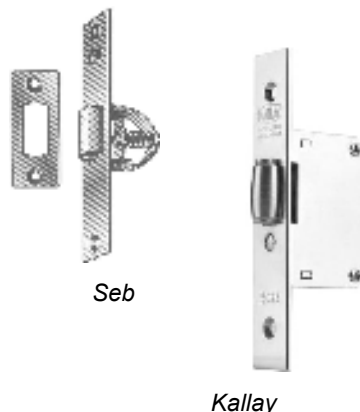

GANCHOS CONTRAVIENTO BRONCE

Código	Descripción	X Caja	U.M.
2126440	75 MM	12	C/U
2126441	100 MM	12	C/U
2126442	125 MM	12	C/U
2126443	150 MM	12	C/U

OBS: EN BRONCE PULIDO CON LACA



GANCHOS ARMARIO

Código	Descripción	X Caja	U.M.
4021001	ARMARIO 25 MM. BDO.	1	CIEN
4021002	ARMARIO 30 MM. BDO.	1	CIEN
4021003	ARMARIO 40 MM. BDO.	1	CIEN
4021004	ARMARIO 50 MM. BDO.	1	CIEN



PASADOR A UÑA ART. 18



Código	Descripción	X Caja	U.M.
CINCADO BRONCEADO			
2020401	2020406 80 MM.	12	C/U
2020402	2020407 100 MM.	12	C/U
2020403	2020408 120 MM.	12	C/U
2020404	2020409 150 MM.	12	C/U
PULIDO PLATIL			
2020411	2020416 80 MM.	12	C/U
2020412	2020417 100 MM.	12	C/U
2020413	2020418 120 MM.	12	C/U
2020414	2020419 150 MM.	12	C/U



PASADOR DE APLICAR "ART. 12"

Código	Descripción	X Caja	U.M.
2020102	60 MM CINCADO	60	C/U
2020108	60 MM BRONCEADO	60	C/U
2020114	60 MM BCE.PULIDO	60	C/U
2020103	70 MM CINCADO	60	C/U
2020109	70 MM BRONCEADO	60	C/U
2020115	70 MM BCE.PULIDO	60	C/U
2020104	100 MM CINCADO	36	C/U
2020110	100 MM BRONCEADO	36	C/U
2020116	100 MM BCE.PULIDO	36	C/U



PASADOR DE APLICAR BRONCE

Código	Descripción	X Caja	U.M.
PULIDO PLATIL			
2433801	24338010 COLIZA 65 MM.	24	C/U
2433802	24338020 COLIZA 100 MM.	24	C/U
2433803	24338030 COLIZA 180 MM.	12	C/U
2433804	24338040 PUENTE PARA PASADOR	12	C/U



PASADOR DE APLICAR "J.M." C/VARILLA REDONDA

Código	Descripción	X Caja	U.M.
2080303	75 MM. BRONCEADO	24	C/U
2080301	75 MM. CINCADO	24	C/U
2080304	100 MM. BRONCEADO	24	C/U
2080302	100 MM. CINCADO	24	C/U



PASADOR DE APLICAR PLASTICO

Código	Descripción	X Caja	U.M.
23532998	CON PASADOR ACODADO BLANCO	50	C/U



PASADOR "ARMARIO"

Código	Descripción	X Caja	U.M.
2080201	50 MM CINCADO AMARILLO	24	C/U
2080202	75 MM CINCADO AMARILLO	24	C/U
2080203	100 MM CINCADO AMARILLO	24	C/U



PASADOR CON PORTACANDADO

Código	Descripción	X Caja	U.M.
2070209	100 MM. CINCADO	12	C/U
2070210	120 MM. CINCADO	12	C/U
2070211	140 MM. CINCADO	6	C/U
2070212	170 MM. CINCADO	6	C/U
2070213	210 MM. CINCADO	6	C/U



PASADOR SIN PORTACANDADO

Código	Descripción	X Caja	U.M.
2070200	C/ PERILLA 100 MM. CINCADO	12	C/U
2070201	C/ PERILLA 120 MM. CINCADO	12	C/U
2070202	C/ PERILLA 140 MM. CINCADO	12	C/U
2070203	C/ PERILLA 170 MM. CINCADO	12	C/U
2070204	C/ PERILLA 210 MM. CINCADO	6	C/U
2070220	PISTOLETE 200 MM. CINCADO	6	C/U
2070221	PISTOLETE 250 MM. CINCADO	6	C/U
2070222	PISTOLETE 300 MM. CINCADO	6	C/U

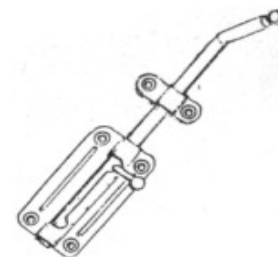
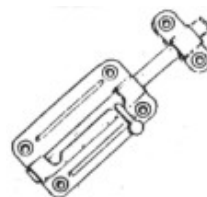

PASADORES "S.C." HIERRO CINCADO

Código	Descripción	X Caja	U.M.
2220407	C/PORTACANDADO 100 MM	12	C/U
2220408	C/PORTACANDADO 140 MM	6	C/U
2220409	C/PORTACANDADO 170 MM	6	C/U
2220401	C/PORT. "MAUSER" 100 MM	6	C/U
2220402	C/PORT. "MAUSER" 145 MM	6	C/U
2220403	C/PORT. "MAUSER" 160 MM	6	C/U
2220404	MAUSER PISTOLETE 200 MM	6	C/U
2220405	MAUSER PISTOLETE 250 MM	6	C/U
2220406	MAUSER PISTOLETE 300 MM	6	C/U

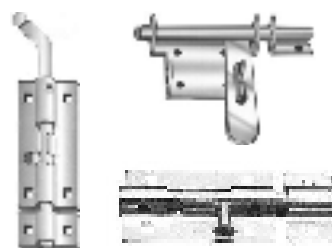

PASADOR COLIZA BRONCE PERILLA FIJA

Código	Descripción	X Caja	U.M.
PULIDO	PLATIL		
2400101	2400105 N° 0 90 X 47	12	C/U
2400102	2400106 N° 1 79 X 43	12	C/U
2400103	2400107 N° 2 65 X 34	24	C/U
2400104	2400108 N° 3 51 X 34	24	C/U



PASADOR COLIZA BRONCE PERILLA C/RESORTE



Código		Descripción		X Caja	U.M.
PULIDO	PLATIL				
2400301	2400305	N° 0	90 X 47	12	C/U
2400302	2400306	N° 1	79 X 43	12	C/U
2400303	2400307	N° 2	65 X 34	24	C/U
2400304	2400308	N° 3	51 X 34	24	C/U

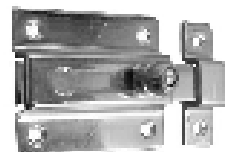

PASADOR COLIZA FUNDIDO LARGO

Código		Descripción		X Caja	U.M.
PULIDO	PLATIL				
2400201	2400205	N° 0 / 180		12	C/U
2400202	2400206	N° 0 / 280		12	C/U
2400203	2400207	N° 2 / 180		24	C/U
2400204	2400208	N° 2 / 280		24	C/U



PASADOR REFORZADO



Código	Descripción		X Caja	U.M.
1140211	YALTRES N.6 P CROMO		1	C/U
1140210	YALTRES N.6 P SIMIL ORO		1	C/U
2432601	BLINDADO (NOGOYA) BR.PULIDO		6	C/U
2432602	BLINDADO (NOGOYA) BR.PLATIL		6	C/U



PASADOR ZAMAK CON TRABA



Código		Descripción		X Caja	U.M.
CINCAD	NEGRO	DORADO			
2221501	2221508	2221520	N°1 35 MM.	12	C/U
2221502	2221509	2221521	N°2 46 MM.	12	C/U
2221503	2221510	2221522	N°3 58 MM.	12	C/U
2221504	2221511	2221523	N°4 80 MM.	12	C/U

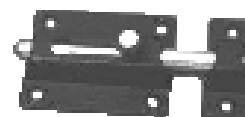

PASADOR DE CHAPA CON TRABA

Código		Descripción		X Caja	U.M.
CINCAD	NEGRO	DORADO			
2070123	2070120	2070126	35 MM	12	C/U
2070124	2070121	2070127	47 MM	12	C/U
2070125	2070122	2070128	57 MM	12	C/U



PASADOR TIPO CERROJO

Código	Descripción		X Caja	U.M.
2070101	35 MM. NEGRO		12	C/U
2070105	35 MM. CINCADO		12	C/U
2070109	35 MM. BRONCEADO		12	C/U
2070102	40 MM. NEGRO		12	C/U
2070106	40 MM. CINCADO		12	C/U

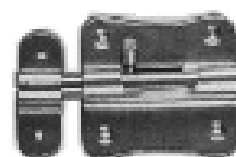

2070110	40 MM. BRONCEADO	12	C/U
2070103	47 MM. NEGRO	12	C/U
2070107	47 MM. CINCADO	12	C/U
2070111	47 MM. BRONCEADO	12	C/U
2070104	57 MM. NEGRO	12	C/U
2070108	57 MM. CINCADO	12	C/U
2070112	57 MM. BRONCEADO	12	C/U
2127030	38 MM. NEGRO (CHINO)	12	C/U
2127031	51 MM. NEGRO (CHINO)	12	C/U

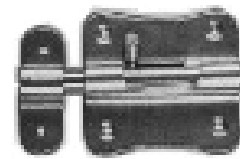

PASADORES FORJADOS

Código	Descripción	X Caja	U.M.
2700319	CON PORTACANDADO 15 CM.	1	C/U
2700320	CON PORTACANDADO 20 CM.	1	C/U
2700321	CON PORTACANDADO 27 CM.	1	C/U
2700322	CON PORTACANDADO 40 CM.	1	C/U
2700330	DE PISO 30 CM.	1	C/U
2700331	DE PISO 50 CM.	1	C/U
2700334	CHATO 10 CM	1	C/U
2700335	CHATO 15 CM	1	C/U
2700336	CHATO 20 CM	1	C/U
2700503	GRAMPA "Z" PARA TRANCA Para tirante de 1.5"	1	C/U



PASADOR MEDIA CAÑA BRONCE

Código	Descripción	X Caja	U.M.
PULIDO	PLATIL		
2432701	24327010 TIPO COLONIAL 130 MM	12	C/U
2432702	24327020 TIPO COLONIAL 180 MM	12	C/U
2432703	24307030 TIPO COLONIAL 300 MM	12	C/U



PASADOR A PALANCA "M H A"

Código	Descripción	X Caja	U.M.
9043315	ACERO 150 MM	20	C/U
9043316	ACERO 200 MM	20	C/U
9043317	ACERO 250 MM	20	C/U
9043318	ACERO 300 MM	20	C/U
9043325	BRONCEADO 150 MM	20	C/U
9043326	BRONCEADO 200 MM	20	C/U
9043327	BRONCEADO 250 MM	20	C/U
9043328	BRONCEADO 300 MM	20	C/U



PASADOR A PALANCA CON PALANCA DE BRONCE



Código	Descripción	X Caja	U.M.
2020601	150MM CINCADO	12	C/U
2020608	150MM BCE. PULIDO	12	C/U
2020615	150MM BCE. PLATIL	12	C/U
2020602	200MM CINCADO	12	C/U
2020609	200MM BCE. PULIDO	12	C/U
2020616	200MM BCE. PLATIL	12	C/U
2020603	250MM CINCADO	12	C/U
2020610	250MM BCE. PULIDO	12	C/U
2020617	250MM BCE. PLATIL	12	C/U
2020604	300MM CINCADO	12	C/U
2020611	300MM BCE. PULIDO	12	C/U
2020618	300MM BCE. PLATIL	12	C/U



ART 220

PASADOR A PALANCA CON PALANCA ESTAMPADA



Código	Descripción	X Caja	U.M.
2090101	100MM CINCADO	12	C/U
2090103	100MM BRONCEADO	12	C/U
2090105	100MM BCE PULIDO	12	C/U
2090107	100MM BCE PLATIL	12	C/U
2090102	120MM CINCADO	12	C/U
2090104	120MM BRONCEADO	12	C/U
2090106	120MM BCE PULIDO	12	C/U
2090108	120MM BCE PLATIL	12	C/U
2020701	150 MM CINCADO	12	C/U
2020706	150 MM BRONCEADO	12	C/U
2020711	150 MM BCE. PULIDO	12	C/U
2020716	150 MM BCE. PLATIL	12	C/U
2020702	200 MM CINCADO	12	C/U
2020707	200 MM BRONCEADO	12	C/U
2020712	200 MM BCE. PULIDO	12	C/U
2020717	200 MM BCE. PLATIL	12	C/U
2020703	250 MM CINCADO	12	C/U
2020708	250 MM BRONCEADO	12	C/U
2020713	250 MM BCE. PULIDO	12	C/U
2020718	250 MM BCE. PLATIL	12	C/U
2020704	300 MM CINCADO	12	C/U
2020709	300 MM BRONCEADO	12	C/U
2020714	300 MM BCE. PULIDO	12	C/U
2020719	300 MM BCE. PLATIL	12	C/U
2020705	400 MM CINCADO	12	C/U
2020710	400 MM BRONCEADO	12	C/U
2020715	400 MM BCE. PULIDO	12	C/U
2020720	400 MM BCE. PLATIL	12	C/U



ART 222



PASADOR CON VARILLA PARA CARPINTERIA METALICA

Código	Descripción	X Caja	U.M.
CON PALANCA DE BRONCE			
2020807	ART. 225 / 180 MM. CINCADO	12	C/U
2020809	ART. 225 / 180 MM. BRONCE	12	C/U
2020808	ART. 225 / 200 MM. CINCADO	12	C/U
2020810	ART. 225 / 200 MM. BRONCE	12	C/U
CON PALANCA DE HIERRO			
2020801	ART. 224 / 180 MM CINCADO	12	C/U
2020802	ART. 224 / 200 MM CINCADO	12	C/U
A UÑA			
2021001	TIPO "MOREAUX" CINCADO	12	C/U

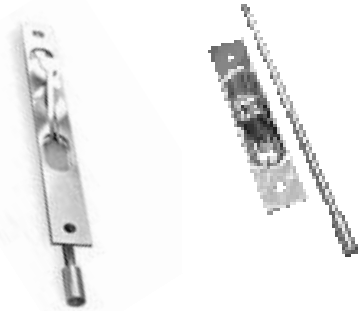

PASADOR TIPO HERRERO

Código	Descripción	X Caja	U.M.
2020501	ART. 25/25 P/SOLDAR	10	C/U
2020502	ART. 25/30 P/SOLDAR	10	C/U
2020503	ART. 25/40 P/SOLDAR	10	C/U
2020504	ART. 25/50 P/SOLDAR	10	C/U
2020506	ART. 26/30 P/ATORNILLAR.	10	C/U
2020507	ART. 26/40 P/ATORNILLAR.	10	C/U
2020508	ART. 26/50 P/ATORNILLAR.	10	C/U
2020520	PUENTE PARA SOLDAR	10	C/U

OBS: El pasador art 25 incluye dos puentes



PASADOR PARA BANDEROLA

Código	Descripción	X Caja	U.M.
2021004	HIERRO CINCADO AZUL	24	C/U
20210040	HIERRO CINCADO AMARILLO	24	C/U
2400601	"STD" BRONCE PULIDO	12	C/U
2400603	"STD" BRONCE PLATIL	12	C/U
2400610	"MINI" BRONCE PULIDO	12	C/U
2400611	"MINI" BRONCE PLATIL	12	C/U
2410752	"H90" ALUMINIO BLANCO	12	C/U
2410753	"H90" ALUMINIO NEGRO	12	C/U

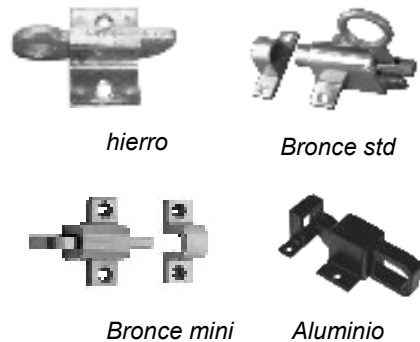

hierro

Bronce std

Bronce mini

Aluminio

PASADOR TIPO BEMA

Código	Descripción	X Caja	U.M.
2080104	20 MM. NEGRO	12	C/U
2080101	20 MM. NIQUEL	12	C/U
2080107	20 MM. BRONCE PULIDO	12	C/U
2080105	25 MM. NEGRO	12	C/U
2080102	25 MM. NIQUEL	12	C/U
2080108	25 MM. BRONCE PULIDO	12	C/U
2080106	30 MM. NEGRO	12	C/U
2080103	30 MM. NIQUEL	12	C/U
2080109	30 MM. BRONCE PULIDO	12	C/U

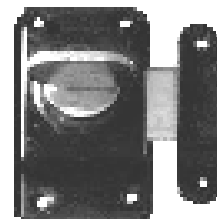

FALLEBA ARRIMAR 12 MM

Código	Descripción	X Caja	U.M.
CAJA DE HIERRO ESTAMPADO			
2000503	101 ARGOLLA BRONCEADA	25	C/U
2000501	101 ARGOLLA CINCADA AZUL	25	C/U
2000502	101 ARGOLLA CINCADA AMARILLA	25	C/U
2090503	102 ARGOLLA BR. PULIDO	15	C/U
2090504	102 ARGOLLA BR.PLATIL	15	C/U
2090505	103 MINISTERIO BR.PULIDO	15	C/U
2090506	103 MINISTERIO BR PLATIL	15	C/U
2090507	104 BISELADA BR PULIDO	15	C/U
2090508	104 BISELADA BR PLATIL	15	C/U
2090523	112 PALANCA DESPL.CINC.DER.	15	C/U
20905231	112 PALANCA DESPL.CINC.IZQ	15	C/U
20905230	112 PALANCA DESPL.BRCEADA DER	15	C/U
20905232	112 PALANCA DESPL.BRCEADA IZQ.	15	C/U

OBS: CON BRONCE VA CAJA BRONCEADA
CON BR.PLATIL VA CAJA CINCADA AZUL



Argolla de hierro

CAJA DE BRONCE ESTAMPADO			
PULIDO	PLATIL		
2090601	2090602	141 ARGOLLA	15 C/U
2090603	2090604	142 MINISTERIO	15 C/U
2090605	2090606	143 BISELADA	15 C/U



Argolla de bronce

CAJA DE BRONCE FUNDIDO			
PULIDO	PLATIL		
2000530	2090702	171 ARGOLLA	15 C/U
2090703	2090704	172 MINISTERIO	15 C/U
2090705	2090706	173 BISELADA	15 C/U
2090707	2090708	174 PAL.RECTA DER	15 C/U
20907070	20907080	174 PAL.RECTA IZQ	15 C/U
2090709	2090710	175 HUEVO	15 C/U
2090711	2090712	176 INGLES	15 C/U
2090713	2090714	177 TROCADERO	15 C/U
2090715	2090716	178 CILINDRO	15 C/U
2090717	2090718	179 ARGOLLA ESTILO	15 C/U
2090719	2090720	180 PAL DESPLAZ.DER	15 C/U
20907190	20907200	180 PAL DESPLAZ.IZQ	15 C/U
2090721	2090722	181 SANATORIO	15 C/U
2090723	20907230	182 ARGOLLA VENEZIA	15 C/U

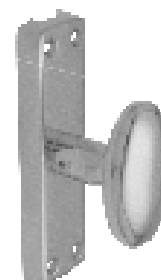

Puño huevo

FALLEBA DE EMBUTIR

Código	Descripción	X Caja	U.M.
CAJA DE HIERRO ESTAMPADO			
2000512	201 ARGOLLA BRONCEADA	25	C/U
2000510	201 ARGOLLA CINCADA	25	C/U
2000511	201 ARGOLLA CINCADA AMARILLA	25	C/U
2090803	202 ARGOLLA BR.PULIDO	15	C/U
2090804	202 ARGOLLA BR.PALTIL	15	C/U
2090805	203 MINISTERIO. BR.PULIDO	15	C/U
2090806	203 MINISTERIO BR.PLATIL	15	C/U



Puño ministerio

2090807	204 BISELADA BR PULIDO	15	C/U
2090808	204 BISELADA BR.PLATIL	15	C/U
2090523	212 BISELADA BR. PLATIL DER	15	C/U
20908231	212 BISELADA BR. PLATIL IZQ	15	C/U
20908230	212 BISELADA BR. PULIDO DER	15	C/U
20908232	212 BISELADA BR. PULIDO IZQ	15	C/U

OBS.: CON BRONCE VA CAJA BRONCEADA
 CON BR.PLATIL VA CAJA CINCADA AZUL

CAJA DE BRONCE ESTAMPADO

PULIDO	PLATIL		
2090901	2090902	231 ARGOLLA	15 C/U
2090903	2090904	232 MINISTERIO	15 C/U
2090905	2090906	233 BISELADA	15 C/U

CAJA DE BRONCE FUNDIDO

PULIDO	PLATIL		
2000531	2091002	271 ARGOLLA	15 C/U
2091003	2091004	272 MINISTERIO	15 C/U
2091005	2091006	273 BISELADA	15 C/U
2091007	2091008	274 PAL.RECTA DER	15 C/U
20910070	20910080	274 PAL.RECTA IZQ	15 C/U
2091009	2091010	275 HUEVO	15 C/U
2091011	2091012	276 INGLES	15 C/U
2091013	2091014	277 TROCADERO	15 C/U
2091015	2091016	278 CILINDRO	15 C/U
2091017	2091018	279 ARG.ESTILO	15 C/U
2091019	2091020	280 PAL.DESPLAZ DER	15 C/U
20910190	20910201	280 PAL.DESPLAZ.IZQ-	15 C/U
2091021	2091022	281 SANATOR	15 C/U
2091023	20910230	282 ARG VENEZIA	15 C/U



Puño cilíndrico



Palanca desplazada der



Palanca recta

FALLEBAS ARRIMAR 18 MM

Código	Descripción	X Caja	U.M.
--------	-------------	--------	------

CAJA DE HIERRO ESTAMPADO

2091100	301 ARGOLLA BRONCEADA	25	C/U
2091102	301 ARGOLLA CINCADA	25	C/U
2091103	302 ARG. BR PULIDO	15	C/U
2091104	302 ARG. BR.PLATIL	15	C/U
2091105	303 MINISTERIO BR.PULIDO	15	C/U
2091106	303 MINISTERIO BR.PLATIL	15	C/U
2091107	304 BISELADA BR.PULIDO	15	C/U
2091108	304 BISELADA BR.PLATIL	15	C/U

CAJA DE BRONCE ESTAMPADO

PULIDO	PLATIL		
2091201	2091202	351 ARGOLLA	15 C/U
2091203	2091204	352 MINISTERIO	15 C/U
2091205	2091206	353 BISELADA	15 C/U



Puño trocadero

CAJA DE BRONCE FUNDIDO

PULIDA	PLATIL			
2091301	2091302	371 ARGOLLA	15	C/U
2091303	2091304	372 MINISTERIO	15	C/U
2091305	2091306	373 BISELADA	15	C/U

**FALLEBA EMBUTIR CAJA 18 MM.**

Código	Descripción	X Caja	U.M.
PULIDA	PLATIL		
2091401	2091402	386 ARGOLLA	15 C/U
2091403	2091404	387 MINISTERIO	15 C/U

**FALLEBA CAJA OVALADA**

Código	Descripción	X Caja	U.M.
CAJA DE HIERRO ESTAMPADO			
2091500	401 ARGOLLA BRONCEADA	25	C/U
2091502	401 ARGOLLA CINCADA	25	C/U
2091503	402 ARGOLLA BR PULIDO	15	C/U
2091504	402 ARGOLLA BR PLATIL	15	C/U
2091505	403 MINISTERIO BR PULIDO	15	C/U
2091506	403 MINISTERIO BR PLATIL	15	C/U

OBS.: CON BRONCE VA CAJA BRONCEADA
CON BR.PLATIL VA CAJA CINCADA AZUL

**CAJA DE BRONCE ESTAMPADO**

PULIDA	PLATIL			
2091601	2091602	441 ARGOLLA	15	C/U
2091603	2091604	442 MINISTERIO	15	C/U
2091605	2091606	443 BISELADA	15	C/U

FALLEBA CAJA CHATA

Código	Descripción	X Caja	U.M.
2091701	501 ARGOLLA BR PUL CAJA BCEADA	15	C/U
2091702	501 ARGOLLA BR PLAT CAJA CINCADA	15	C/U
2091703	502 MINISTERIO PUL CAJA BCEADA	15	C/U
2091704	502 MINISTERIO PLAT CAJA CINCADA	15	C/U

**FALLEBA CELOSIA HIERRO**

Código	Descripción	X Caja	U.M.
CAJA DE HIERRO ESTAMPADO			
2091900	601 ARGOLLA BRONCEADA	25	C/U
2000520	601 ARGOLLA CINCADA	25	C/U
2091903	602 ARG. BR PULIDO	15	C/U
2091904	602 ARG. BR PLATIL	15	C/U
2091905	603 MINISTERIO BR PULIDO	15	C/U
2091906	603 MINISTERIO BR PLATIL	15	C/U

OBS.: CON BRONCE VA CAJA BRONCEADA
CON BR.PLATIL VA CAJA CINCADA AZUL



Para varilla cuadrada

CAJA DE BRONCE ESTAMPADO

PULIDA	PLATIL			
2092001	2092002	651 ARGOLLA	15	C/U
2092003	2092004	652 MINISTERIO	15	C/U

FALLEBA TIPO GOLIAT

Código	Descripción	X Caja	U.M.
2021006	MECANISMO (SIN PUÑO)	10	C/U
2250801	PUÑO GOLIAT MINISTERIO PULIDO	12	C/U
22508010	PUÑO GOLIAT MINISTERIO PLATIL	12	C/U
2250803	PUÑO GOLIAT BISELADO PULIDO	12	C/U
22508030	PUÑO GOLIAT BISELADO PLATIL	12	C/U



VARILLAS PARA FALLEBA

Código	Descripción	X Caja	U.M.
PLANAS, PARA EMBUTIR			
2000120	HIERRO FALLEBA EMBUTIR 1 MT	26	C/U
2000122	HIERRO FALLEBA EMBUTIR 1,20 MT	26	C/U
2000123	HIERRO FALLEBA EMBUTIR 1,50 MT	26	C/U
2000124	HIERRO FALLEBA EMBUTIR 2,00 MT	26	C/U



MEDIA CAÑA, PARA ARRIMAR HIERRO

HIERRO	DORADO	Medida		
2000101	2000130	12x1 MT	26	C/U
2000103	2000132	12x1,20 MTS	26	C/U
2000104	2000133	12x1,50 MTS	26	C/U
2000105	2000134	12x2 MTS	26	C/U
2000110	2000140	18x1 MT	26	C/U
2000112	2000142	18x1,20 MTS	26	C/U
2000113	2000143	18x1,50 MTS	26	C/U
2000114	2000144	18x2 MTS	26	C/U



MEDIA CAÑA ARRIMAR BRONCE

PULIDO	PLATIL			
2000160	2000170	12x1 MT	26	C/U
20001601	20001701	12x1,20 MTS	26	C/U
20001602	20001702	12x1,50 MTS	26	C/U
20001603	20001703	12x2 MTS	26	C/U
2000161	2000171	18x1 MT	26	C/U
20001611	20001711	18x1,20 MTS	26	C/U
20001612	20001712	18x1,50 MTS	26	C/U
20001613	20001713	18x2 MTS	26	C/U



CUADRADA, PARA CELOSIA

2000180	1 MT	26	C/U
20001801	1.20 MTS	26	C/U
20001802	1.50 MTS	26	C/U
20001803	2.00 MTS	26	C/U

ACCESORIOS PARA FALLEBAS

Código	Descripción		X Caja	U.M.
CONTRAFRENTES				
2092500	12 BRONCEAD	2092504 CINCADO	50	C/U
2092507	12 BR PULIDO	2092510 BR PLATIL	50	C/U
2092513	18 BRONCEAD	2092505 CINCADO	50	C/U
2092508	18 BR PULIDO	2092511 BR.PLATIL	50	C/U
GUARNICIONES 12 MM				
2092420	BRONCEADA	2092404 CINCADA	50	C/U
2092407	ESTAMP. PUL.	2092410 EST.PLAT	50	C/U
2092413	FUNDIDA PUL	2092415 FUND PLA	50	C/U
GUARNICIONES 18 MM				
2092421	BRONCEADA	2092405 CINCADA	50	C/U
2092408	ESTAMP PUL	2092411 EST PLAT	50	C/U
2092414	FUNDIDA PUL	2092416 FUND PLA	50	C/U



FALLEBA LINEA VERSALLES

Código	Descripción		X Caja	U.M.
2095201	PUÑO HUEVO		1	C/U
2095202	PUÑO INGLES		1	C/U
2095207	PUÑO SANATORIO		1	C/U
2095203	PUÑO TROCADERO		1	C/U
2095205	PUÑO ARGOLLA ESTILO		1	C/U
2095204	PUÑO CILINDRO		1	C/U
2095206	PUÑO PALANCA DESPLAZADA		1	C/U
2095208	PUÑO ARGOLLA VENECIANA		1	C/U
PASADORES LINEA VERSALLES				
2095230	PASADOR 300MM		1	C/U
2095231	PASADOR 400MM		1	C/U
VARILLAS Y ACCESORIOS				
2095220	19 MM		1	MT.
2095240	GUARNICIÓN VERSALLES SIMPLE		1	C/U
2095241	GUARNICIÓN VERSALLES DOBLE		1	C/U
2095242	CONTRAFRENTE VERSALLES		1	C/U

OBS.: TERMINACION PULIDO CON LACA



FALLEBAS LINEA FORJADA

Código	Descripción		X Caja	U.M.
2690160	ARRIMAR 12MM RULO		1	C/U
2690162	ARRIMAR 18MM RULO		1	C/U
2690172	ARRIMAR 12MM RETORCIDA		1	C/U
2690174	ARRIMAR 18MM RETORCIDA		1	C/U
2690161	EMBUTIR RULO		1	C/U
2690173	EMBUTIR RETORCIDA		1	C/U

OBS: Herrajes forjados en pag.11

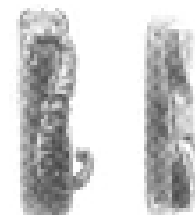



RETENES A RODILLO

Código	Descripción	X Caja	U.M.
9043005	"MHA" CINCADO AZUL	100	C/U
9043006	"MHA" CINCADO AMARILLO	100	C/U
2410514	IND.ARG. CINCADO AZUL	100	C/U
2410513	IND.ARG. BRONCEADO	100	C/U



RETENES A IMAN DE ARRIMAR

Código	Descripción	X Caja	U.M.
2200104	R-2 COMUN BLANCO	100	C/U
2200105	R-2 COMUN MARRON	100	C/U
2200106	R-2 COMUN TOSTADO	100	C/U
22001060	R-2 COMUN NEGRO	100	C/U
2200107	R-9 REFORZADO BLANCO	50	C/U
2200108	R-9 REFORZADO MARRON	50	C/U
2200109	R-9 REFORZADO TOSTADO	50	C/U
22001090	R-9 REFORZADO NEGRO	50	C/U
2200110	R-11 CHICO BLANCO	150	C/U
2200111	R-11 CHICO MARRON	150	C/U
2200112	R-11 CHICO TOSTADO	150	C/U
22001120	R-11 CHICO NEGRO	150	C/U
2200116	R-32 DOBLE BLANCO	50	C/U
2200117	R-32 DOBLE MARRON	50	C/U
2200118	R-32 DOBLE TOSTADO	50	C/U
22001180	R-32 DOBLE NEGRO	50	C/U
2200150	TRAMO ADHESIVO (1 METRO)	1	C/U
2200230	CONTRAFRENTE DOS AGUJEROS	100	C/U
2200231	CONTRAFRENTE UN AGUJERO	100	C/U

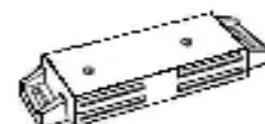

RETENES A IMAN DE EMBUTIR

Código	Descripción	X Caja	U.M.
2200202	R-4 FRENTE DE ALUMINIO	50	C/U
2200201	R-3 FRENTE DE BRONCE	50	C/U
2200203	R-10 FRENTE DE BRONCE REF.	50	C/U



R3/R4



R10

RETENES EXPULSORES

Código	Descripción	X Caja	U.M.
3240301	SIMPLE A IMAN	50	C/U
3240302	DOBLE A IMAN	50	C/U
235329940	HAFELE TIPO LACHT	12	C/U
9121070	EXPULSOR MAGIC PLUS FERRARI Expulsa la puerta 25 mm	20	C/U

simple



doble



"latch"

Magic plus

RETENES A PRESION PLASTICOS

Código	Descripción	X Caja	U.M.
2200207	"R-17" REFORZADO BLANCO	100	C/U
2200208	"R-17" REFORZADO MARRON	100	C/U
3120101	TIPO SILLITA LIVIANO MARRON	200	C/U
3120102	TIPO SILLITA LIVIANO BLANCO	200	C/U

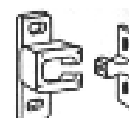

R-17



Sillita

RETENES VAIVEN METAL

Código	Descripción	X Caja	U.M.
3081504	BOTIQUIN NIQUEL	100	C/U
3081516	A BOLILLA 9.5MM. BRONCEADO	100	C/U
3081513	*CUADRADO 11MM. NIQUEL	100	C/U
3081514	*CUADRADO 16MM. NIQUEL	100	C/U
OBS: *hasta agotar stock			
23532997	RETEN PARA DOBLE HOJA	12	C/U

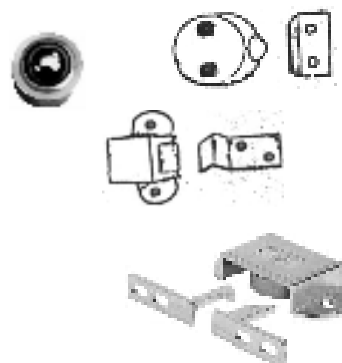

RETENES A BOLILLA

Código	Descripción	X Caja	U.M.
RETENES TUBULARES			
3350113	ART.125 SIN ALA DIAM.12 MM	50	C/U
3350112	ART.126 SIN ALA DIAM.10 MM	50	C/U
3350111	ART.127 CON ALA DIAM. 8 MM	50	C/U
3350110	ART.128 CON ALA DIAM. 7 MM	50	C/U
3350118	ART.129 SIN ALA DIAM.7 MM		
3350115	ART.131 CON ALA DIAM.10 MM	50	C/U
3350116	ART.132 CON ALA DIAM.12 MM	50	C/U
RETENES DE EMBUTIR			
3350101	DE EMBUTIR ART. 133 CHICO	50	C/U
3350102	DE EMBUTIR ART. 134 GRANDE	50	C/U
RETENES DE ARRIMAR			
9043017	DE ARRIMAR 43 MM BCE	50	C/U
9043018	DE ARRIMAR 50 MM BCE	50	C/U

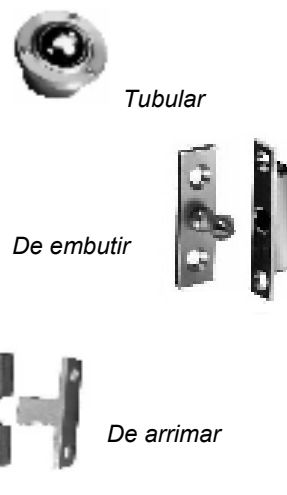

TIJERAS DE CHAPA

Código	Descripción	X Caja	U.M.
3081403	CORRED.140 MM. BRONCEADA	24	C/U
3081401	CORRED.140 MM. NIQUELADA	24	C/U
3081404	CORRED.180 MM. BRONCEADA	24	C/U
3081402	CORRED.180 MM. NIQUELADA	24	C/U
OBS: La medida es la de la pieza que tiene la corredera.			
3081205	A TOPE 100 MM. BRONCEADA DER	24	C/U
3081206	A TOPE 100 MM. BRONCEADA IZQ.	24	C/U
3081207	A TOPE 150 MM. BRONCEADA DER	24	C/U
3081208	A TOPE 150 MM. BRONCEADA IZQ.	24	C/U
OBS: La medida corresponde a cada brazo			
2080906	C/FRENO 200 MM BLANCA	24	C/U
3081301	VARILLA C/TOPE 200 MM MARRON	24	C/U
OBS: La medida corresponde al brazo.			



TIJERAS DE BRONCE

Código	Descripción	X Caja	U.M.
PULIDO PLATIL			
2491101	2491106 COMPAS 7,5 CM	12	PAR
2491102	2491107 COMPAS 100 CM	12	PAR
2491103	2491108 COMPAS 125 CM	12	PAR
2491104	2491109 COMPAS 150 CM	12	PAR
2491105	2491110 COMPAS 175 CM	12	PAR



TIJERA PARA PUERTA LEVADIZA

Código	Descripción	X Caja	U.M.
9121050	TIJERA A FRICCION "KLOCK" OBS: Permite dejar la puerta en cualquier angulo.	12	C/U
2353360	TIJERA CON TRABA MANUAL DER	12	C/U
2353361	TIJERA CON TRABA MANUAL IZQ	12	C/U
9041501	TIJERA C/CAIDA CONTROLADA DER	12	C/U
9041502	TIJERA C/CAIDA CONTROLADA IZQ.	12	C/U
9121051	TIJERA A GAS "AKROBAT" NM80 OBS: Incluye las punteras para madera o aluminio	10	C/U
9121052	SISTEMA WING A 45° 480 MM	1	C/U
9121053	SISTEMA WING PARALELO 350 MM	1	C/U
9121054	SISTEMA WING PARALELO 480 MM	1	C/U
9121056	TUBO ESTABILIZADOR X 1.20 MT OBS: compuesto por dos brazos y dos amortiguadores	1	C/U



"klock"



Manual



Caída controlada



"akrobat"



Punteras p/akrobat

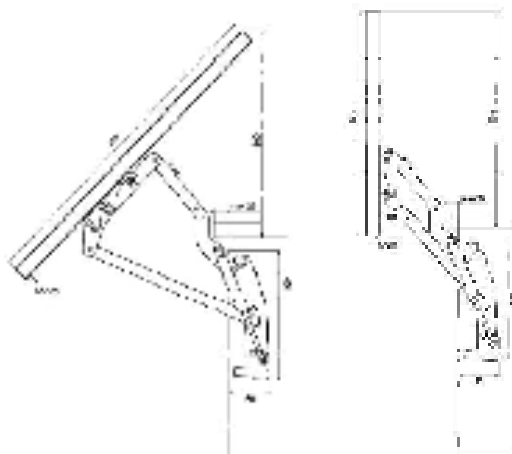

Wing a 45°

Wing paralelo



TOPES PARA PUERTAS DE MUEBLES

Código	Descripción	X Caja	U.M.
2360350	MEDIA ESF. TRASLUCIDO ADHESIVO	10	CIEN
2200507	MEDIA ESF. BLANCO P/CLAVO	10	CIEN
2200508	MEDIA ESF. BLANCO P/EMBUTIR	10	CIEN
22005101	CHATO BLANCO P/EMBUTIR	10	CIEN
22005100	CHATO TRANSLUCIDO P/EMBUTIR	10	CIEN



adhesivo



Para clavar



Med.esf de emb.



Chato de embutir



AMORTIGUADORES PARA PUERTAS DE MUEBLES

Código	Descripción	X Caja	U.M.
91210600	AMORTIGUADOR A AIRE	24	C/U
9121060	AMORTIGUADOR A ACEITE	24	C/U
9121061	CARCAZA PARA AMORTIGUADOR	24	C/U
9121059	AMORTIGUADOR "SI-SOFTECH"	24	C/U

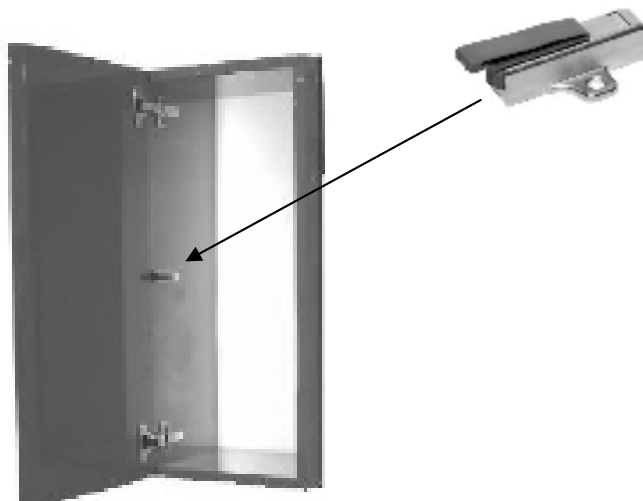

PLANCHUELAS PORTACANDADO

Código	Descripción	X Caja	U.M.
2070302	PORTACANDADO CINCO 18X35	12	C/U
2070304	PORTACANDADO CINCO 18X55	12	C/U
2070306	PORTACANDADO CINCO 28X80	12	C/U
2070308	PORTACANDADO CINCO 39X70	12	C/U
2070310	PORTACANDADO CINCO 39X80	12	C/U
2070312	PORTACANDADO CINCO 39X90	12	C/U
2070314	PORTACANDADO CINCO 39X100	12	C/U
2070318	PORTACANDADO CINCO 39X120	12	C/U
1390501	PORTACANDADO "CEPO"	1	C/U
2700315	FORJADO NEGRO PARA BAUL	1	C/U
2127050	PORTACANDADO CHAROL 1 1/2"	12	C/U
2127051	PORTACANDADO CHAROL 2"	12	C/U
2127052	PORTACANDADO CHAROL 2 1/2"	12	C/U
2127053	PORTACANDADO CHAROL 3"	12	C/U
2127054	PORTACANDADO CHAROL 3 1/2"	12	C/U
2127055	PORTACANDADO CHAROL 4"	12	C/U
2127056	PORTACANDADO CHAROL 5"	12	C/U



BROCHES CON PORTACANDADO

Código	Descripción	X Caja	U.M.
CON PORTACANDADO			
1240601	63 MM. CINCO	50	C/U
1240603	63 MM. BRONCEADO	50	C/U
1240602	100 MM. CINCO	25	C/U
1240612	100 MM. BRONCEADO	25	C/U
SIN PORTACANDADO			
1240604	40 MM. CINCO	100	C/U
1240605	40 MM. BRONCEADO	100	C/U
1240610	63 MM. CINCO	50	C/U
1240613	63 MM. BRONCEADO	50	C/U
1240611	100 MM. CINCO	25	C/U
1240614	100 MM. BRONCEADO	25	C/U



BROCHES PARA VALIJAS Y CAJAS

Código	Descripción	X Caja	U.M.
1240620	30 MM. BRONCEADO	100	C/U
1240623	30 MM. NIQUELADO	100	C/U
1240621	45 MM. BRONCEADO	100	C/U
1240624	45 MM. NIQUELADO	100	C/U
1240622	63 MM. BRONCEADO	100	C/U
1240625	63 MM. NIQUELADO	100	C/U
BROCHES LABRADOS			
3480101	1025 CON AGUJEROS	100	C/U
3480102	1030 CON PINCHES AUTOCLAVABLE	100	C/U

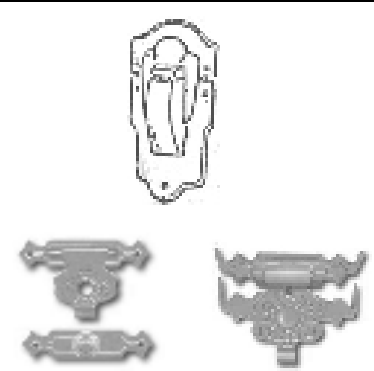

OBS: Bisagras para estuches en pag.44

CANASTOS GIRATORIOS

Código	Descripcion	U.M.
GIRATORIOS BLANCOS		
3400101	GIRATORIO 40 CM ENTERO	C/U
3400102	GIRATORIO 40 CM C/CORTE	C/U
3400103	GIRATORIO 50 CM ENTERO	C/U
3400104	GIRATORIO 50 CM C/CORTE	C/U
3400105	GIRATORIO 60 CM ENTERO	C/U
3400106	GIRATORIO 60 CM C/CORTE	C/U
3400107	GIRATORIO 70 CM ENTERO	C/U
3400108	GIRATORIO 70 CM C/CORTE	C/U
3400109	GIRATORIO 80 CM C/CORTE	C/U
3400110	GIRATORIO 76 CM MEDIO CIRCULO	C/U
GIRATORIOS CROMADOS		
3400111	GIRATORIO 50 CM ENTERO	C/U
3400112	GIRATORIO 60 CM ENTERO	C/U
3400113	GIRATORIO 70 CM ENTERO	C/U
3400114	GIRATORIO 70 CM C/CORTE	C/U
3400115	GIRATORIO 80 CM C/CORTE	C/U
3400116	GIRATORIO 76 CM MEDIO CIRCULO	C/U

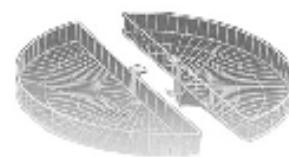

OBS: El juego se compone de dos canastos y un barral

PORTARESIDUOS

Código	Descripcion	U.M.
EXTRAIBLES CON CORREDERA		
3400121	P/PUERTA BATIENTE 300X430X480	C/U
OBS: Al abrir la puerta el recipiente sale y se levanta la tapa del mismo Con corredera común, epoxi blanco		
3400122	FRONTAL 300X500X480 BLANCO	C/U
3400123	FRONTAL 300X500X480 CROMADO	C/U
OBS: La puerta se fija a la estructura y sale hacia delante (como un cajón) Con corredera de bolillas.		
9130111	FRONTAL 250X395X410 ACERO.	C/U
OBS: Se abre la puerta y se extrae manualmente Con guía de bolilla; base y tapa gris. Capacidad 17 lts.		
5220550	SIMPLE CON TAPA GIRATORIA	C/U
OBS: 240x360x610 con guía de bolilla. En plástico reforzado gris.		
5220551	DOBLE CON TAPA GIRATORIA	C/U
OBS: 360x505x630 con guía de bolilla. En plástico reforzado gris. Medidas: ancho x alto x profundidad		



5220555	SIMPLE TAPA GIRATORIA OBS: 270X410X260 con guía de bolilla. En plástico reforzado blanco	C/U
5220556	DOBLE TAPA GIRATORIA OBS: 305X380X480 con guía de bolilla. En plástico reforzado blanco	C/U



EXTRAIBLES PIVOTANTES

3210101	CUADRADO BLANCO	C/U
3210104	CIRCULAR BLANCO OBS: 300 X 300 X 270 Capacidad 10 lts. Tapa y lateral blanco. Balde extraíble.	C/U
23534126	CIRCULAR ACERO INOXIDABLE OBS: 300 X 300 X 270 Capacidad 10 lts. Tapa plástica negra. Balde extraíble.	C/U
9130110	TRIANGULAR ACERO INOXIDABLE OBS: 360 X 345 X 355 Capacidad 25 lts. Tapa plástica gris. Balde extraíble.	C/U



CANASTOS EXTRAIBLES BLANCOS

Código	Descripcion	U.M.
3400140	CANASTO 3 CAJONES 300X500X480	C/U
3400141	CANASTO 2 CAJONES 270X270X160 OBS: Estructura fija, bandejas deslizantes.	C/U
3400285	CANASTO 3 NIVELES 360X530X450	C/U
3400270	CANASTO 2 NIVELES 200X530X450 OBS: Con guías de bolilla telescópicas	C/U
3400230	CANASTO CAJON 355X140X450	C/U
3400232	CANASTO CAJON 405X140X450	C/U
3400234	CANASTO CAJON 445X140X450	C/U
3400236	CANASTO CAJON 505X140X450	C/U
3400238	CANASTO CAJON 555X140X450	C/U
3400240	CANASTO CAJON 605X140X450 OBS: Con guías de bolilla telescópicas	C/U
3400150	CANASTO VOLCABLE 250X450X340	C/U
3400151	CANASTO VOLCABLE 350X450X340 OBS.: Medidas: ancho x alto x profundidad	C/U

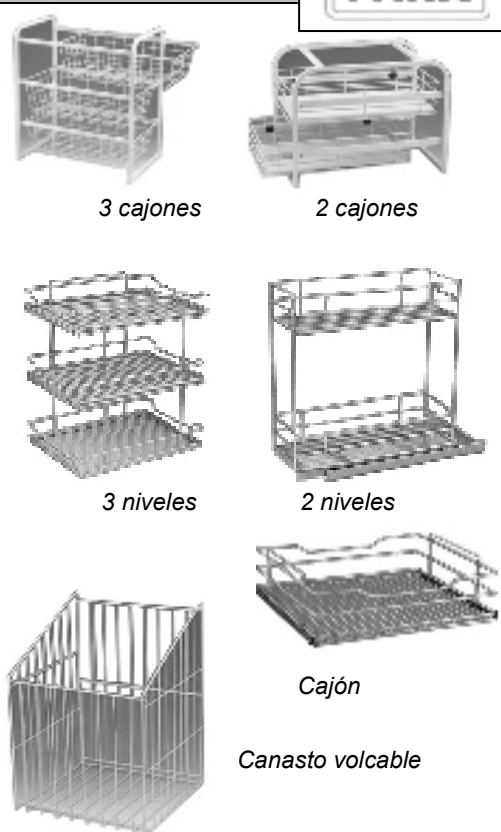

3 cajones

2 cajones

3 niveles

2 niveles

Cajón

Canasto volcable

LINEA BLANCA "ROMA"

PROFUNDIDAD 500 MM:

2384701	CANASTO CAJON 130X500X190	881-12
2384706	CANASTO CAJON 370X500X170	881-37

OBS: Con guias comunes.

Medidas: ancho x profundidad x alto

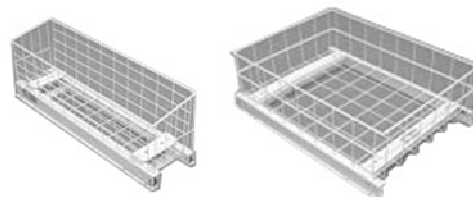

881-12

881-37

2384702	CANASTO 2 NIVELES 195X500X520	881-18
2384703	CANASTO 2 NIVELES 200X500X485	881-20
2384704	CANASTO 3 NIVELES 300X500X470	881-30
2384808	CANASTO 3 NIVELES 345X500X520	882-35
2384807	CANASTO 3 NIVELES 500X540X500	882-48
2384709	CANASTO 2 NIVELES 515X500X520	881-50
2384707	CANASTO P/ROPA 360X500X510	881-38
2384714	DESPENSERO 4 NIV. 330X500X1300	881-33
2384806	DESPENSERO 5 NIV. 450X500X1730	882-45

OBS: Con guias comunes.



881-18

881-20



881-30

882-35



881-33

882-45



881-50

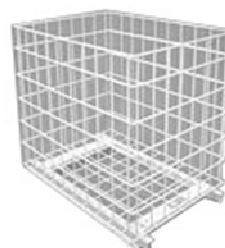

881-38



882-48

CANASTOS DE POCA PROFUNDIDAD

2384902	CANASTO 2 NIVELES 360X300X280	883-30
2384904	CANASTO P/ROPA 300X360X430	883-38
2384906	CANASTO P/ROPA 500X360X430	883-34



883-30



883-34

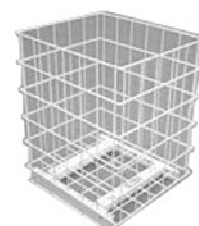

883-38



CANASTOS EXTRAIBLES CROMADOS

Código	Descripcion	U.M.
3400284	CANASTO 3 NIVELES 360X530X450	C/U
3400268	CANASTO 2 NIVELES 200X530X450	C/U
OBS: Con guias de bolilla telescopicas		
3400231	CANASTO CAJON 355X140X450	C/U
3400233	CANASTO CAJON 405X140X450	C/U
3400235	CANASTO CAJON 445X140X450	C/U
3400237	CANASTO CAJON 505X140X450	C/U
3400239	CANASTO CAJON 555X140X450	C/U
3400241	CANASTO CAJON 605X140X450	C/U

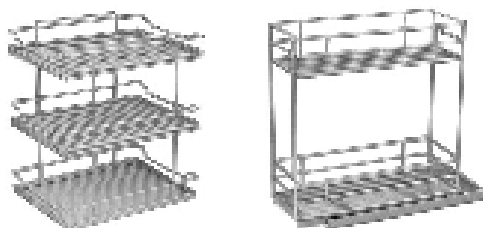

2 niveles

3 niveles

OBS: Con guias de bolilla telescopicas

CANASTO BAJO BACHA "U"

3400310	CANASTO B/BACHA 864X140X450	C/U
3400311	CANASTO CAJON 864X140X450	C/U
3400312	CANASTO B/BACHA 964X140X450	C/U
3400313	CANASTO CAJON 964X140X450	C/U

OBS.: Medidas: ancho x alto x profundidad



Tipo cajón.

RINCONERO "MAGIC"

2353413	/199 RINCONERO "MAGIC" DER	C/U
2353413	/1990 RINCONERO "MAGIC" IZQ	C/U
2353413	/1991 AMORTIGUADOR PARA RINCONERO	C/U

OBS.: Indicar mano (derecha o izquierda)

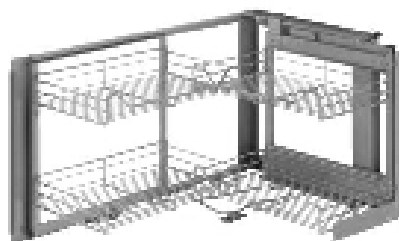

Magic

RINCONERO "REVERSUS"

5220543	BANDEJA LAMINADA REVERSIBLE	C/U
---------	-----------------------------	-----

OBS: Hecha de melamina laminada blanca
Incluye el soporte para la misma.
Se provee en forma unitaria.

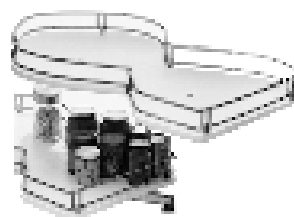

Reversus

DESPENSERO CROMADO

2353413	/196 COLUMNA EXTR. MODULO 300	C/U
2353413	/197 COLUMNA EXTR. MODULO 400	C/U
2353416	/198 AMORTIGUADOR P/COLUMNA	C/U

Incluye los cinco canastos.

5220542	COLUMNA EXTRAIBLE 350 MM	C/U
---------	--------------------------	-----

Incluye 6 canastos

Altura máxima 2.00 mts.





ACCESORIOS DE COLGAR CROMADOS

Código	Descripcion	U.M.
PARA CAÑO REDONDO (5/8")		
3400203	MULTIUSO 3 NIVELES	C/U
3400204	PORTAROLLO TRIPLE	C/U
3400205	PORTAROLLO SIMPLE	C/U
3400206	PORTAROLLO SIMPLE C/ESPECIERO	C/U
3400207	ESCURREPLATOS GRANDE	C/U
3400208	ESCURREPLATOS CHICO	C/U
3400209	ESCURREPLATOS C/BANDEJA	C/U
3400210	ESTANTE GRANDE	C/U
3400211	ESPECIERO SIMPLE	C/U
3400212	ESPECIERO DOBLE	C/U
3400213	ESQUINERO SIMPLE	C/U
3400218	GANCHO "S"	C/U
3400219	BARRA 5/8 X 450 MM	C/U
3400220	BARRA 5/8 X 600 MM	C/U
3400221	BARRA 5/8 X 900 MM	C/U
3400222	BARRA 5/8 X 1200 MM	C/U
3400223	BARRA 5/8 X 1500 MM	C/U
3400224	BARRA 5/8 X 2000 MM	C/U
3400217	SOPORTE PARA BARRAL CENTRAL	C/U
3400210	SOPORTE PARA BARRAL LATERAL	C/U



multiuso

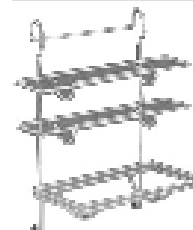

Portarollo triple



simple



Simple con especiero

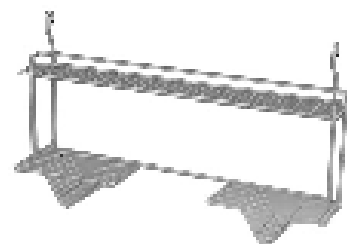

Escurreplatos doble

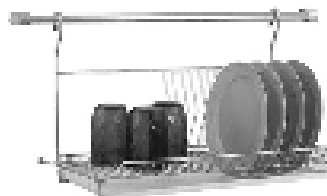

Escurreplatos c/bandeja



Escurreplatos simple



Especiero doble



Especiero simple



Estante grande

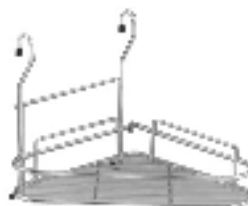

Esquinero



sportes



Caños-Ganchos "s"

PARA CAÑO RECTANGULAR

5220501	PORTACUBIERTOS Medidas:205x135x150	C/U
5220502	ESPECIERO RINCONERO DOBLE Medidas:255x255x255	C/U
5220504	ESPECIERO DOBLE CHICO Medidas:275x260x125	C/U
5220512	ESCURRIDOR DE PARED Medidas:370x355x275	C/U
5220514	KIT CAÑO + SOPORTE 60 CM	C/U
5220515	KIT CAÑO + SOPORTE 120 CM	C/U
5220520	PORTARROLLO P/PAPEL ALUMINIO	C/U
5220521	PORTARROLLO GRANDE Medidas:180x335x170	C/U
5220522	PORTARROLLO TRIPLE Medidas:360x335x170	C/U

Medidas:alto x ancho x profundidad



portacubiertos



Especiero rinconero



Especiero chico



Escurreidor



Barral-soportes



Portarollo p/papel aluminio



Portarollo grande



Portarollo triple

ACCESORIOS DE COLGAR EN ACERO



Código	Descripcion	U.M.
SERIE CLASSIC		
9130101	BARRA 60 CM (CON 2 SOPORTES)	C/U
9130102	BARRA 120 CM (CON 3 SOPORTES)	C/U
9130170	MULTIUSO	C/U
9130171	ESPECIERO	C/U
9130172	ESPECIERO MULTIUSO	C/U
9130173	PORTACUBIERTOS	C/U
9130174	PORTAROLLO TRIPLE	C/U
9130175	PORTAROLLO SIMPLE	C/U
9130180	RINCONERO	C/U
9130190	GANCHO "S"	C/U
9130125	ESCURREPLATOS DE COLGAR	C/U

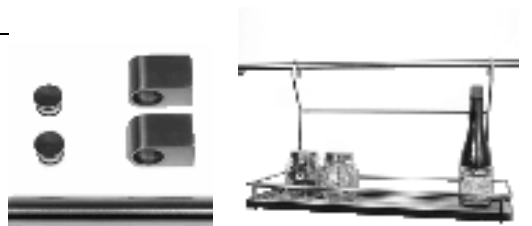

Barra

Multiuso



Portacubiertos

Especiero multiuso



Especiero



Portarollo triple

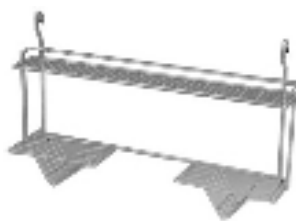

Escurreplatos



Portarollo simple



Rinconero

SERIE ELEGANCE

9130160	BARRA 100 CM (CON SOPORTES)	C/U
9130161	BARRA 60 CM (CON SOPORTES)	C/U
9130130	MULTIUSO	C/U
9130131	MULTIUSO MAXI	C/U
9130135	PORTACUBIERTO	C/U
9130136	PORTACUCHILLOS	C/U
9130145	COLGADOR 6 GANCHOS	C/U



Barra

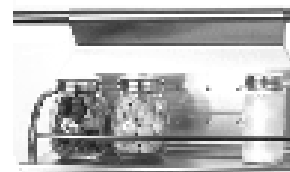

Multiuso



Portacuchillos



Colgador 6 ganchos



Multiuso maxi



Portacubiertos

ACCESORIOS PARA ALACENA CROMADOS

Código	Descripcion	U.M.
3400260	ESCURREPLATOS 560 MM	C/U
3400261	ESCURREPLATOS 760 MM	C/U
3400262	ESCURREPLATOS 860 MM	C/U

OBS.: Compuesto por tres piezas: Bandeja para platos, para vasos, y escurridora
La medida hace referencia al modulo.

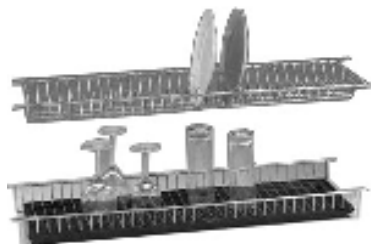

ACCESORIOS PARA ALACENA EN ACERO

Código	Descripcion	U.M.
9130120	ESCURREPLATOS 600 MM	C/U
9130121	ESCURREPLATOS 900 MM	C/U
9130122	ESCURREPLATOS 1000 MM	C/U

OBS.: COMPUESTO POR TRES BANDEJAS:
PARA PLATOS; PARA VASOS; Y ESCURRIDORA
LA MEDIDA SE REFIERE AL MODULO.

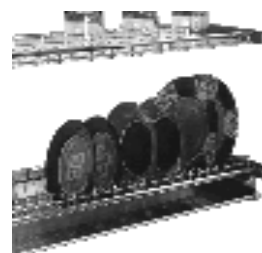

ACCESORIOS PARA CAJONES

Código	Descripcion	U.M.
CUBIERTEROS		
3400130	BLANCO 300X470	C/U
3400131	BLANCO 350X470	C/U
3400132	BLANCO 400X500	C/U
3400133	BLANCO 500X600	C/U
2353430	GRIS 240X485X50	C/U
2353431	GRIS 340X485X50	C/U
2353432	GRIS 390X485X50	C/U
2353433	GRIS 440X485X50	C/U
2353434	GRIS 540X485X50	C/U
2353435	GRIS 740X485X50	C/U
2353436	GRIS 840X485X50	C/U
2353437	GRIS 940X485X50	C/U

OBS: Medidas: ancho x profundidad x altura

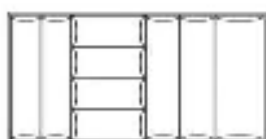
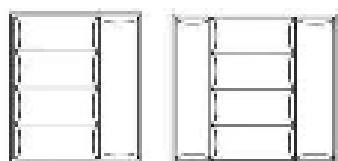
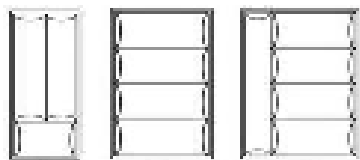
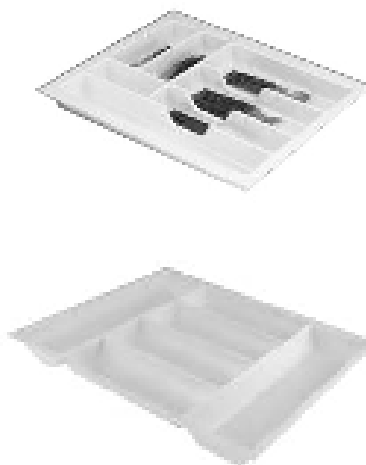

ACCESORIOS PARA MESADA CROMADOS

Código	Descripcion	U.M.
3400163	ESCURREPLATOS TIJERA 300X270X340	C/U
3400161	ESCURREPLATOS DE CAÑO 480X350X260	C/U
5220525	PORTALATAS "ROLLER"	C/U
3400201	BODEGA FIJA	C/U



Porta platos



Esc. de caño



Esc. tijera



Bodega

ACCESORIOS PARA MESADA ACERO

Código	Descripcion	U.M.
ESCURRIDORES		
9130105	DE UN PISO PARA 16 PLATOS	C/U
9130106	DE DOS PISOS PARA 16 PLATOS	C/U
9130107	DE UN PISO PARA 22 PLATOS	C/U

OBS: Todos con bandeja en acero inoxidable.

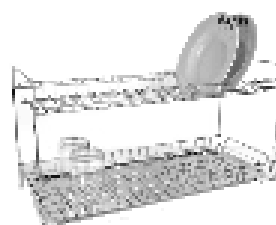

ACCESORIOS VARIOS

Código	Descripcion	U.M.
PORTACOPAS CROMADOS		
3400225	PORTACOPA RECTO 420 MM	C/U
3400226	PORTACOPA RECTO 250 MM	C/U
3400227	PORTACOPA CURVO	C/U
3400228	PORTACOPA OVALADO	C/U
3400229	PORTACOPA REDONDO	C/U
2354100	PORTACOPA RECTO 260 MM	C/U
2354102	PORTACOPA RECTO 340 MM	C/U



Redondo

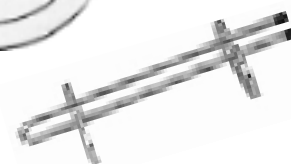

Recto 420-250



Curvo



Oval



Recto 260-340

PISOS DE ALUMINIO

3701101	1164X570	C/U
3701102	964X570	C/U
3701103	864X570	C/U
3701104	764X570	C/U
3701105	564X570	C/U

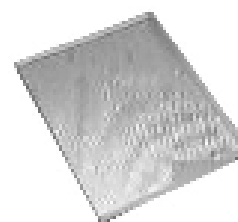

BARRALES DE SUJECCION PARA BAÑOS

Código	Descripcion	U.M.
3031000	BARRA RECTA 300 MM	C/U
3031001	BARRA RECTA 450 MM	C/U
3031002	BARRA RECTA 600 MM	C/U
3031003	BARRA RECTA 800 MM	C/U
3031010	BARRA INCLINADA 500 MM	C/U
3031020	BARRA ANGULO 90' 500X700 MM	C/U
3031030	BARRA PISO-PARED 600X700 MM	C/U
3031040	BARRA REBATIBLE 600 MM	C/U
3031041	BARRA REBATIBLE 800 MM	C/U

OBS: Terminacion epoxi blanco.

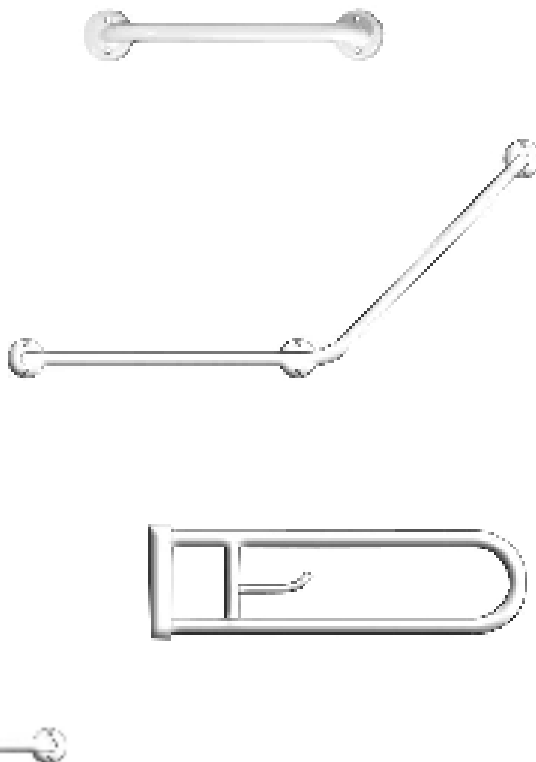

HERRAJES PARA DIVISIONES DE BAÑOS

Código	Descripcion	U.M.
2710101	ESCUADRA DE DOS PIEZAS	JGO
2710102	ESCUADRA DE TRES PIEZAS	JGO
2710103	ESCUADRA DOS PZAS ESQUINERA	JGO
2710104	PATA PARA TABIQUE 30 CM	C/U
2710105	BISAGRA	C/U
2710106	TOPE PARA PUERTA	C/U

OBS: Terminacion bronce platil mate.

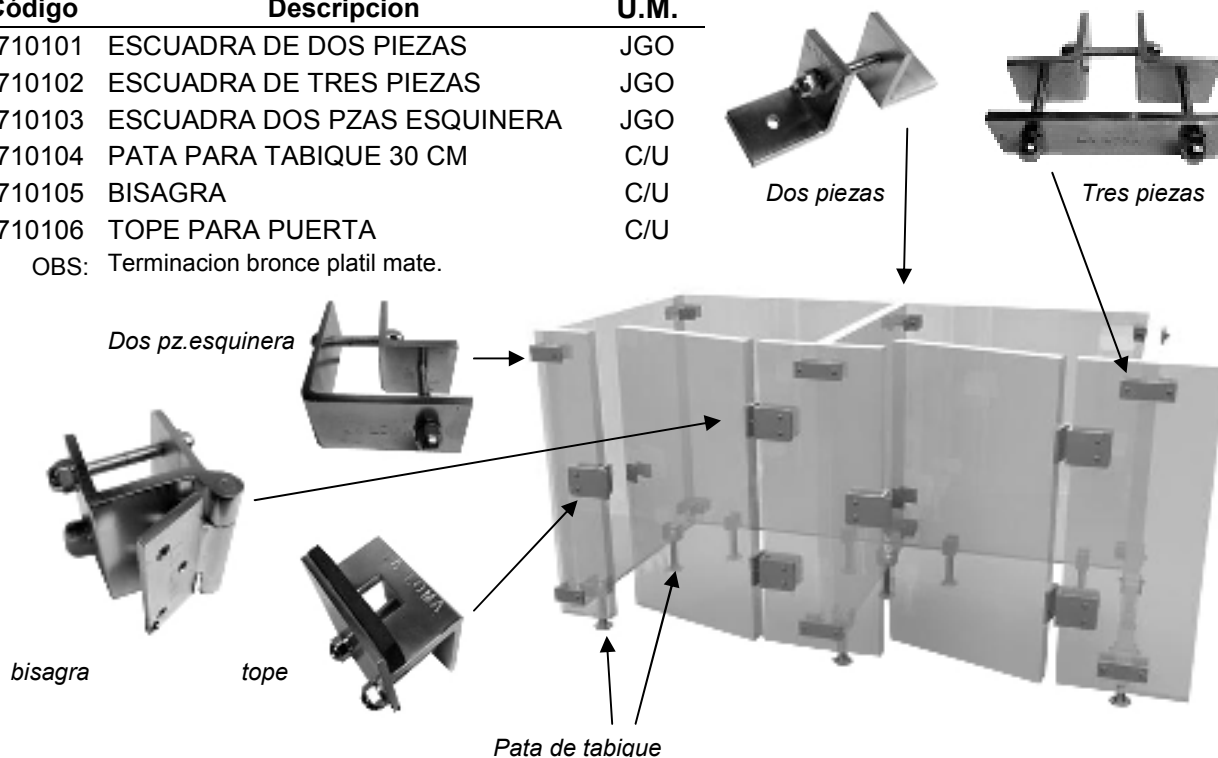



BOTINEROS

Código	Descripción	U.M.
BOTINEROS AL PISO		
3400170	PARA 8 PARES NEGRO	C/U
34001700	PARA 8 PARES NEGRO – HAYA	C/U
34001701	PARA 8 PARES BLANCO	C/U
3400171	PARA 8 PARES CROMO-HAYA	C/U
34001710	PARA 8 PARES CROMO-NEGRO	C/U
34001711	PARA 8 PARES CROMO-BLANCO	C/U
3400174	PARA 12 PARES NEGRO	C/U
34001740	PARA 12 PARES NEGRO-HAYA	C/U
34001741	PARA 12 PARES BLANCO	C/U
3400175	PARA 12 PARES CROMO-HAYA	C/U
34001750	PARA 12 PARES CROMO-NEGRO	C/U
34001751	PARA 12 PARES CROMO-BLANCO	C/U



Para 8 pares

REJILLA SOLA PARA BOTINERO		
3400176	CUATRO AROS NEGRA	C/U
34001760	CUATRO AROS BLANCA	C/U
3400177	CUATRO AROS CROMO	C/U
3400180	SEIS AROS NEGRA	C/U
34001800	SEIS AROS BLANCA	C/U
3400181	SEIS AROS CROMO	C/U



Cuatro aros

GANCHO "U" PARA BOTINERO		
3400182	COLOR NEGRO	C/U
34001820	COLOR GRIS	C/U
3400183	CROMADO	C/U

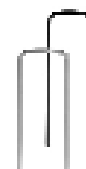

Aro solo

BOTINEROS REGULABLES TELESCOPICOS		
3400184	REGULABLE 44 A 58 CM NEGRO	C/U
3400185	REGULABLE 44 A 58 CM CROMO	C/U
3400186	REGULABLE 76 A 90 CM NEGRO	C/U
3400187	REGULABLE 76 A 90 CM CROMO	C/U

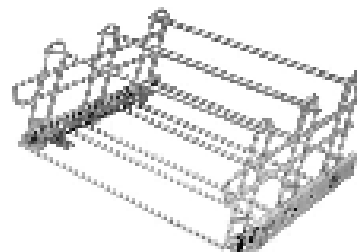

Botinero regulable

BOTINEROS REGULABLES SIN GUIAS		
3400188	REGULABLE 62 A 89 CM CROMO	C/U
3400189	REGULABLE 79 A 96 CM CROMO	C/U



Regulable sin guias

BOTINERO LATERAL		
3400190	COLOR NEGRO	C/U
3400191	CROMADO	C/U

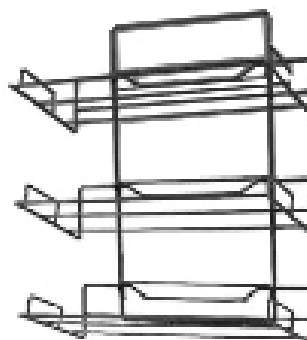

lateral



PANTALONEROS

Código	Descripción	U.M.
PANTALONEROS EXTRAIBLES		
3400192	LATERAL NEGRO	C/U
34001920	LATERAL CROMADO	C/U
3400194	CENTRAL NEGRO	C/U
3400193	CENTRAL CROMADO	C/U
OBS: Con correderas telescópicas		
4670101	EXTRAÍBLE Y VOLCABLE	C/U
OBS: En gris aluminio con detalles negros		

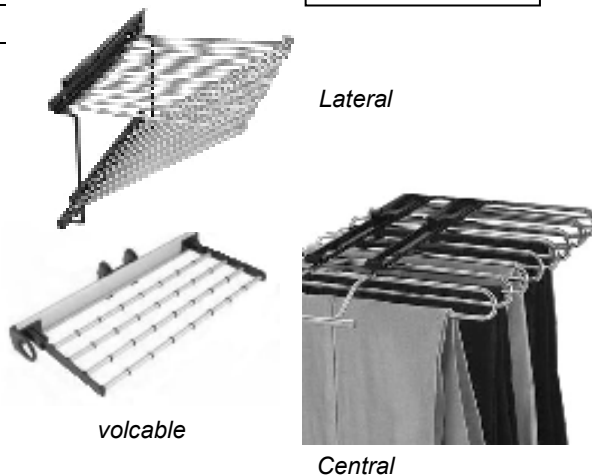

CORBATEROS - COLGADORES

Código	Descripción	U.M.
CORBATEROS-ORGANIZADORES METALICOS		
3400195	P/ CORBATAS Y CINTOS CROMO	C/U
34001950	P/ CORBATAS Y CINTOS NEGRO	C/U
3400196	CORBATERO CROMO	C/U
34001960	CORBATERO NEGRO	C/U
ALUMINIO CON PLASTICO		
4670102	CINTURONERO	C/U
4670103	CORBATERO	C/U
4670104	CORBATERO CON CAJITA	C/U
OBS: En gris aluminio con detalles negros		



CUELGA TRAJE

3700207	CUELGA TRAJE 8 MM CROMADO	C/U
---------	---------------------------	-----

PERCHERO REBATIBLE

Código	Descripción	U.M.
9129010	ELEVADOR DE ROPA REGULABLE DE 83 A 115 CM	C/U



CAÑOS PARA PLACARD			
Codigo	Descripcion	x caja	u.m.
CAÑO OVAL PLACARD			
9043501	CAÑO OVAL CROMADO ITALIANO	30	Mt.
3070503	CAÑO OVAL NEGRO	30	Mt.
30705030	CAÑO OVAL BLANCO	30	Mt.
3070505	CAÑO OVAL BRONCEADO	30	Mt.
30705010	CAÑO OVAL CINCADO AZUL	30	Mt.
3070501	CAÑO OVAL CINCADO AMARILLO	30	Mt.
3235080	CAÑO OVAL ALUMINIO ANODIZADO	10	C/U
SOPORTES PARA CAÑO OVAL			
9043506	LATERAL CROMO	50	C/U
3071006	LETERAL NEGRO	50	C/U
3071004	LATERAL DORADO	50	C/U
9043801	CENTRAL NIQUEL (c/tornillo pasante)	50	C/U
9044021	TORNILLO M6 P/SOPORTE	50	C/U
3071010	CENTRAL NIQUEL	50	C/U
3071014	CENTRAL NEGRO	50	C/U
3071012	CENTRAL DORADO	50	C/U
TAPA CAÑO OVAL			
3701503	PLASTICO GRIS	100	C/U
3701504	PLASTICO NEGRO	100	C/U
CAÑOS REDONDOS P/PLACARD			
3070103	CAÑO ¾ CINCADO AZUL	45	Mt.
30701030	CAÑO ¾ CINCADO AMARILLO	45	Mt.
3070104	CAÑO 1" CINCADO AZUL	30	Mt.
30701040	CAÑO 1" CINCADO AMARILLO	30	Mt.
SOPORTES P/CAÑO REDONDO			
3081102	SOPORTE LATERAL ¾ NIQUEL	50	C/U
3081103	SOPORTE LATERAL 1" NIQUEL	50	C/U
3081109	SOPORTE LATERAL ¾ BRONCEADO	50	C/U
3081111	SOPORTE LATERAL 1" BRONCEADO	50	C/U
3081105	SOPORTE CENTRAL ¾ NIQUEL	50	C/U
3081106	SOPORTE CENTRAL 1" NIQUEL	50	C/U
3081108	SOPORTE CENTRAL ¾ BCEADO	50	C/U
3081112	SOPORTE CENTRAL 1" BRONCEADO	50	C/U
2200719	LATERAL PLASTICO 5/8 BLANCO	50	C/U
22007190	LATERAL PLASTICO 5/8 MARRON	50	C/U
2200720	LATERAL PLASTICO 3/4 BLANCO	50	C/U
22007200	LATERAL PLASTICO 3/4 MARRON	50	C/U

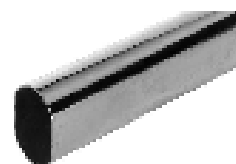

En tiras de 3 mts



En tiras de 3 mts.



SOPORTES METALICOS			
Código	Descripción	X Caja	U.M.
2360102	ESCUADRA BRONCEADO	2	CIEN
2360101	MACIZO BRONCEADO	1	CIEN
2360103	TUBO BRONCEADO	3	CIEN
2110901	DIÁMETRO 5 MM. NIQUELADO	1	CIEN
2110902	DIÁMETRO 5 MM. BRONCEADO	1	CIEN
2110903	DIAMETRO 5 MM. NEGRO	1	CIEN



SOPORTES PLASTICOS

Código	Descripción	X Caja	U.M.
SOPORTE Y TUBO PLASTICO			
2200745	SOPORTE PLASTICO BLANCO	1	CIEN
22007450	SOPORTE PLASTICO MARRON	1	CIEN
22007451	SOPORTE PLASTICO NEGRO	1	CIEN
2200746	TUBO PLASTICO BLANCO	3	CIEN
22007460	TUBO PLASTICO MARRON	3	CIEN
22007461	TUBO PLASTICO NEGRO	3	CIEN
SOPORTE CON PERNO METALICO			
9125001	CON PERNO 5 MM TRANSPARENTE	1	CIEN
9125002	CON PERNO 5 MM BLANCO	1	CIEN
9125003	CON PERNO 5 MM MARRON	1	CIEN
9125004	CON PERNO 5 MM NEGRO	1	CIEN
ESCUADRAS TRIANGULARES CON TAPA			
3760109	TRANSPARENTE	2.5	CIEN
3760110	BLANCO	2.5	CIEN
3760111	ALMENDRA	2.5	CIEN
3760112	HAYA	2.5	CIEN
3760113	HAYA NATURAL	2.5	CIEN
3760114	MARFIL	2.5	CIEN
3760115	CEREZO	2.5	CIEN
3760116	MARRON CLARO	2.5	CIEN
3760117	MARRON OSCURO	2.5	CIEN
3760118	NEGRO	2.5	CIEN
3760119	GRIS CLARO	2.5	CIEN

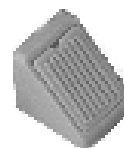

CARROS CAMA

Código	Descripción	X Caja	U.M.
2160102	CARRO 180 X 80 CM	1	C/U
2160101	CARRO 180 X 70 CM	1	C/U

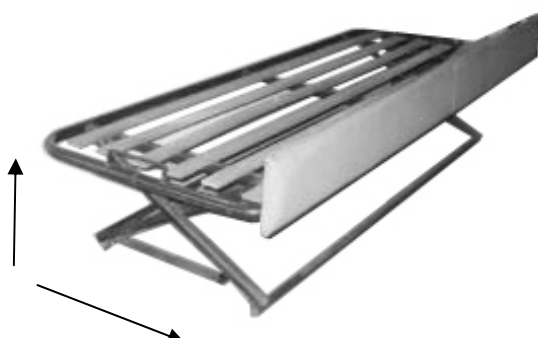

(Sin el frente)

ELEMENTOS PARA OFICINA-RACKS

Código	Descripción	u.m.
CHASIS PORTACARPETAS		
2420102	CHASIS SIMPLE 400X415	C/U
2420105	CHASIS DOBLE 400X840	C/U
CAJONES PARA DINERO		
3000301	DE 3 DIVISIONES CON BOTON	C/U
3000302	DE 4 DIVISIONES CON BOTON	C/U
3000303	DE 5 DIVISIONES CON BOTON	C/U
BANDEJAS		
3000320	DE 3 DIVISIONES	C/U
3000321	DE 4 DIVISIONES	C/U
3000322	DE 5 DIVISIONES	C/U
PORTATECLADOS		
2420108	METALICO EPOXI NEGRA 412X410	C/U
2353439	PLASTICO NEGRA CON LAPICERO	C/U
23534390	PLASTICO GRIS CON LAPICERO	C/U
23533741	CORREDERA P/BANDEJA P/TECLADO	PAR
PORTA CPU		
2420160	PORTA CPU LATERAL	C/U
2420161	PORTA CPU RODANTE	C/U
PASACABLES		
5220200	REDONDO 60 MM NEGRO	C/U
5220201	REDONDO 60 MM BLANCO	C/U
52202010	REDONDO 60 MM CENIZA	C/U
52202011	REDONDO 60 MM GRIS HUMO	C/U
52202012	REDONDO 60 MM PLATA	C/U
52202013	REDONDO 60 MM MARRON	C/U
52202014	REDONDO 60 MM BEIGE	C/U
23599995	REDONDO 80 MM GRIS CLARO	C/U
23534124	REDONDO 80 MM MARRON	C/U
23534123	REDONDO 80 MM NEGRO	C/U
23534121	REDONDO 80 MM GRIS ACERO	C/U
23534122	RECTANGULAR 246X102 ACERO	C/U
2353412A	RECTANGULAR 246X102 ALUMINIO	C/U
2353412B	RECTANGULAR 246X102 GRIS	C/U
2353412C	RECTANGULAR 246X102 NEGRO	C/U

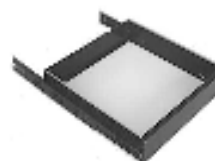

Chasis simple

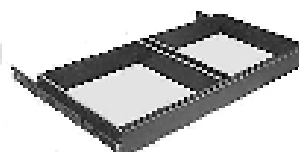

Chasis doble



cajon



bandejas



Portateclado plastico

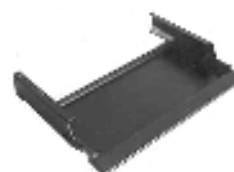

Portateclado metal

Correderas



Porta cpu rodante



Porta cpu



VERTEBRA PASACABLE

5220210	PLASTICO TRASLUCIDO	C/U
---------	---------------------	-----

PASAPAPEL

3760810	RECTANGULAR BEIGE	C/U
3760811	RECTANGULAR MARRON	C/U
3760812	RECTANGULAR NEGRO	C/U

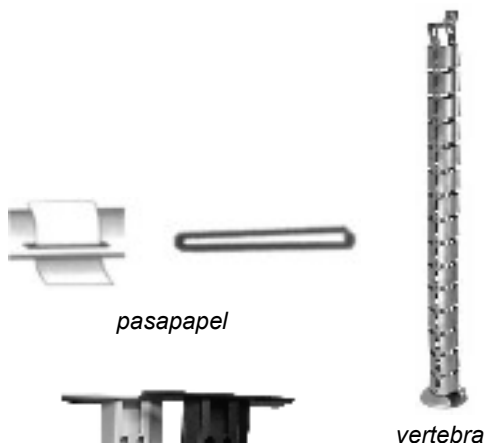

pasapapel

vertebra

BASES PARA ESCRITORIOS

2420140	BASE LATERAL PARA ESCRITORIO	C/U
2420141	BASE CENTRAL PARA ESCRITORIO	C/U
2420142	PERFIL TRAVESAÑO 50X80X1000	C/U
2420143	SOPORTE CORREDIZO (PARA FIJAR EL TRAVESAÑO A LA TAPA)	C/U



SOPORTES PARA MONITORES LCD

<i>POR FAVOR CONSULTAR SOBRE ESTE PRODUCTO</i>	C/U
<i>ESTE PRODUCTO</i>	C/U



Soportes para monitor lcd



Extensible y giratorio



Base giratoria

base chica y rueditas

BASES PARA GIRAR ESTANTES

4670152	BASE GIRATORIA GRANDE	C/U
4670150	SOPORTE TV EXTENSIBLE	C/U
2353445	BASE GIRATORIA CHICA	C/U
2353440	RUEDITA PARA BASE CHICA	C/U



Recto 330 mm esquinera

PORTA CD'S Y CASSETTES

2911002	PORTA CD RECTO 330 MM	PAR
4670202	*PORTA CD ESQUINERO	C/U
4670203	*PORTA CD C/APOYO LATER	C/U
5220215	PORTA CD CURVO P/12 CD NEGRO	C/U
5220216	PORTA CD CURVO P/12 CD GRIS	C/U
4670208	*PORTA VIDEO CASSETTE	C/U

OBS: *Discontinuados.Consultar stock

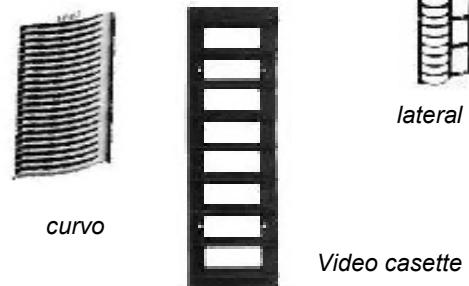

curvo

Video cassette

lateral

SOPORTES PARA TV Y LCD'S

Código	Descripción	X Caja	U.M.
8500101	PARA TV HASTA 21"	1	C/U
8500102	PARA TV HASTA 21" Y VIDEO	1	C/U
2640101	LCD BASCULANTE 19"-32"	1	C/U
2640102	LCD BASCULANTE 33"-63"	1	C/U
2640103	LCD BASCULANTE EXTENSIB.19-32	1	C/U
2640106	LCD BASCULANTE EXTENSIB.33-63	1	C/U



CORREDERAS "Z"

BE CUSA

codigo	descripcion	xcaja	u.m.
LINEA "BECUSA"			
9041060	30 CMTS BLANCA	25	PAR
9041061	35 CMTS BLANCA	25	PAR
9041062	40 CMTS BLANCA	25	PAR
9041063	45 CMTS BLANCA	25	PAR
9041064	50 CMTS BLANCA	25	PAR
OBS.: Espesor 0.8 mm			



LINEA "FERRARI"			
9122501	25 CMTS ALMENDRA	20	PAR
9122502	30 CMTS ALMENDRA	20	PAR
9122503	35 CMTS ALMENDRA	20	PAR
9122504	40 CMTS ALMENDRA	20	PAR
9122505	45 CMTS ALMENDRA	20	PAR
9122506	50 CMTS ALMENDRA	20	PAR
9122507	55 CMTS ALMENDRA	20	PAR
9122508	60 CMTS ALMENDRA	20	PAR
9122510	25 CMTS NEGRA	20	PAR
9122511	30 CMTS NEGRA	20	PAR
9122512	35 CMTS NEGRA	20	PAR
9122513	40 CMTS NEGRA	20	PAR
9122514	45 CMTS NEGRA	20	PAR
9122515	50 CMTS NEGRA	20	PAR
9122516	55 CMTS NEGRA	20	PAR
9122517	60 CMTS NEGRA	20	PAR
OBS.: Espesor 0.9 mm			

ferrari



CORREDERAS CON LATERAL "FERRARI"

ferrari

9123701	86X400 ALMENDRA	10	PAR
9123702	86X450 ALMENDRA	10	PAR
9123703	86X500 ALMENDRA	10	PAR
9123704	118X400 ALMENDRA	5	PAR
9123705	118X450 ALMENDRA	5	PAR
9123706	118X500 ALMENDRA	5	PAR
9123707	150X500 ALMENDRA	5	PAR



CORREDERAS A BOLILLA TELESCOPICAS "FERRARI"

LINEA "FERRARI"			
9123501	25 CMTS CINCADA	15	PAR
9123502	30 CMTS CINCADA	15	PAR
9123503	35 CMTS CINCADA	15	PAR
9123504	40 CMTS CINCADA	10	PAR
9123505	45 CMTS CINCADA	10	PAR
9123506	50 CMTS CINCADA	10	PAR
9123507	55 CMTS CINCADA	15	PAR
9123508	60 CMTS CINCADA	15	PAR
9123509	65 CMTS CINCADA	15	PAR
9123510	70 CMTS CINCADA	15	PAR



BECUSA

LINEA "BECUSA"

9041050	30 CMTS NEGRA	15	PAR
9041051	35 CMTS NEGRA	15	PAR
9041052	40 CMTS NEGRA	15	PAR
9041053	45 CMTS NEGRA	15	PAR
9041054	50 CMTS NEGRA	15	PAR
9041055	55 CMTS NEGRA	15	PAR
9041056	60 CMTS NEGRA	15	PAR



CORREDERAS A BOLILLA MINI

Código	Descripción	X Caja	U.M.
2353370	EXTRACCIÓN SIMPLE 182 MM	50	PAR
2353371	EXTRACCIÓN SIMPLE 246 MM	50	PAR
2353372	EXTRACCIÓN SIMPLE 310 MM	50	PAR



CORREDERAS P/PUERTAS GIRATORIAS

Código	Descripción	X Caja	U.M.
2353367	P/PUERTA OCULTA 35 CM	10	PAR
23533671	P/PUERTA OCULTA 40 CM	10	PAR
23533672	P/PUERTA OCULTA 45 CM	10	PAR
23533673	P/PUERTA OCULTA 50 CM	10	PAR
23533674	P/PUERTA EXTERNA "MOCHILA"	10	PAR

OBS: Para puertas de hasta 7 kgm.



Para puerta oculta



Puerta externa "mochila"

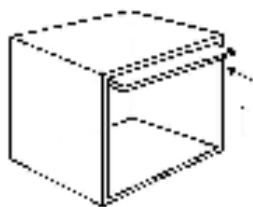

Puerta oculta

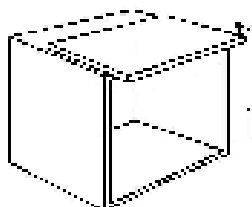

Puerta "mochila"

CORREDERAS OCULTAS

Código	Descripción	X Caja	U.M.
9123951	CINCADA 35 CM	10	PAR
9123952	CINCADA 40 CM	10	PAR
9123953	CINCADA 45 CM	10	PAR
9123954	CINCADA 50 CM	10	PAR
9123955	CINCADA 55 CM	10	PAR

ferrari

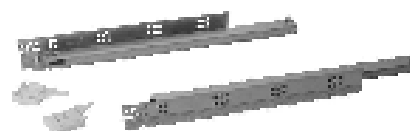

CORREDERAS CON LATERAL Y AMORTIGUACION "F-1 BOX"

Código	Descripción	X Caja	U.M.
LATERAL DE CAJON BASICO			
9123901	86X400 GRIS	1	PAR
9123902	86X500 GRIS	1	PAR
9123903	160X400 GRIS	1	PAR
9123904	160X500 GRIS	1	PAR
9123905	200X400 GRIS	1	PAR
9123906	200X500 GRIS	1	PAR

OBS: En 160 y 200, pedir por separado el guardacantos.

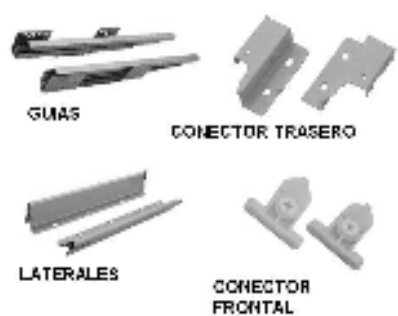

ACCESORIOS Y COMPLEMENTOS

9123920	CONECTOR 86 MM P/CAJON INTERIOR	1	C/U
9123921	CONECTOR 150 MM P/CAJON INTERIOR	1	C/U
9123925	PANEL FRONTAL P/CAJON INTERIOR	1	C/U
9123928	BARRA FRONTAL P/CAJON INTERIOR	1	C/U
9123929	MANIJA P/CAJON INTERIOR	1	C/U
9123940	PARED LATERAL 400 MM GRIS	1	PAR
9123941	PARED LATERAL 500 MM GRIS	1	PAR
9123945	GUARDACANTOS GRIS 400	1	PAR
9123946	GUARDACANTOS GRIS 500	1	PAR

Componentes básicos.

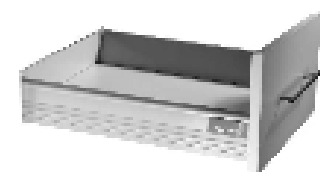

Guardacantos

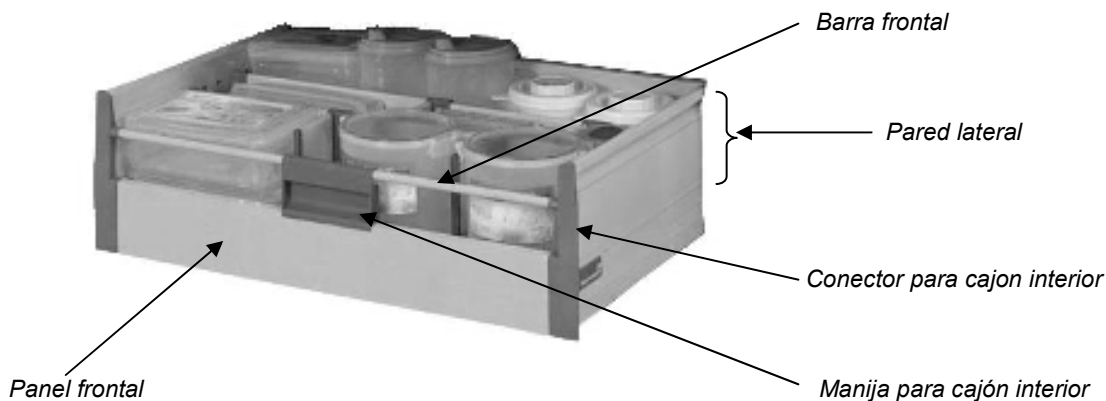

PERFILES DE ALUMINIO PARA PUERTAS

Código	Descripción	U.M.
3701150	PERFIL 20-20 CURVO "MARE"	MT
3701152	PERFIL 20-45 RECTO "SCALE"	MT
3701154	PERFIL 20-45 CURVO "VENTO"	MT
37011540	PERFIL 20-45 ½ CAÑA "TERRA"	MT
37011541	PERFIL 20-20 CURVO "BREZZA"	MT
37011542	PERFIL 20-20 RECTO "PIANNO"	MT
3701170	PERFIL 20-45 RECTO FINO "LINEA"	MT

OBS: El precio incluye el armado y perforado para las bisagras

VIDRIOS

3701171	ESMERILADO 4 MM	M2
3701173	OPACID 4 MM	M2
3701176	PACIFIC 4 MM	M2

OBS: El precio incluye la colocación en la puerta
Bisagras para mueble de cocina en pag:49

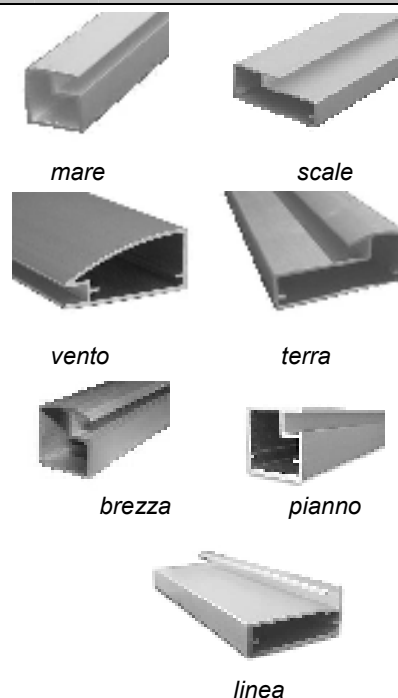

TAPACANTOS DE ALUMINIO

Código	Descripción	x Caja	U.M.
3230000	TAPACANTO CON ARPON X 3 MT.	60	C/U
3230001	TAPACANTO "U" 18 MM X 3 MT.	40	C/U
3230004	TERMINAL CROMO	100	C/U
3230005	TERMINAL CROMO MATE	100	C/U

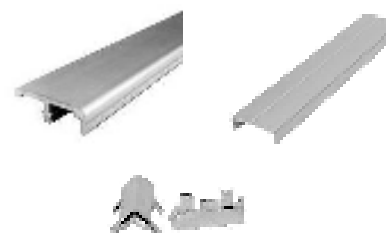

PERFILES DE ALUMINIO PARA MANIJAS Y FRENTEROS

Código	Descripción	x Caja	U.M.
4360009	PERFIL "C" 64x23.5	3	MT
4360010	PERFIL "J" 49x22.8	3	MT
4360205	SOPORTE ESCUADRA PARA C Y J	50	C/U
4360206	SOPORTE AL CENTRO PARA C Y J	50	C/U
4360013	PERFIL MANIJA "ALBA" 20.9x45	3	MT
4360020	PERFIL MANIJA "ALBA 04" 23.8x44	3	MT
4360022	PERFIL MANIJA "ALBA 06" 28X21	3	MT
4360026	PERFIL "ADRIANO" 40.4x8	3	MT
4360030	PERFIL "VINCO" SUPLEMENTO	3	MT
4360031	PERFIL "VINCO"	3	MT

OBS: Medidas en mm. En tiras de 3 mts.

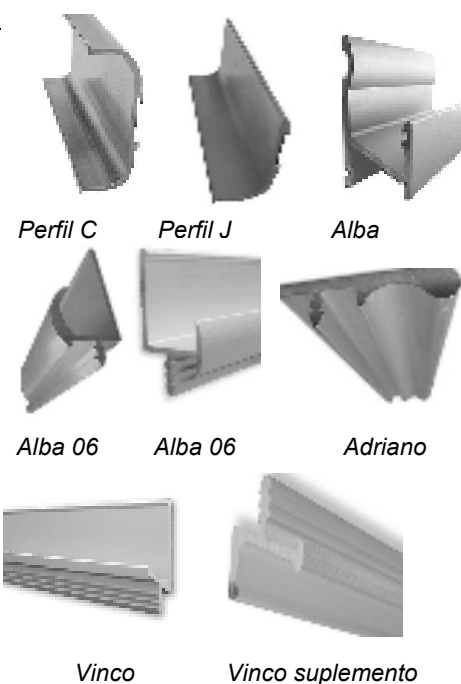
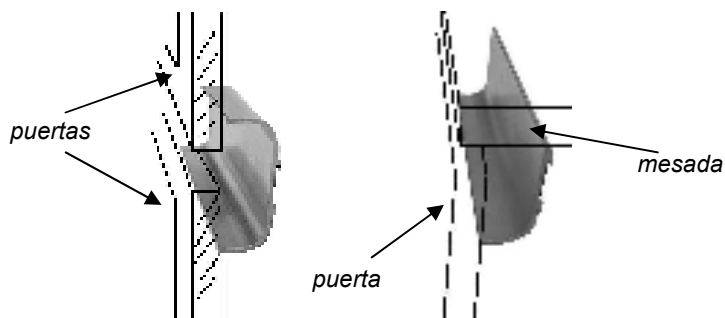

PERSIANAS PARA MUEBLES

Código	Descripción	X Caja	U.M.
3290101	PERFIL BASE E2 x2.50	1	C/U
3290102	PERFIL RIEL 8 MM NEGRO x 2.50	1	C/U
3290103	PERFIL PERSIANA E23 X 2.50	1	C/U
3290104	PERFIL CIERRE E2 X 2.50	1	C/U
3290105	PIEZA GUIA/FRENO NEGRA	1	C/U
3290106	CURVA A 90° NEGRA	1	C/U

OBS: Perfil guía, riel, curva, y freno en color negro
Los perfiles base, persiana y cierre son en color aluminio

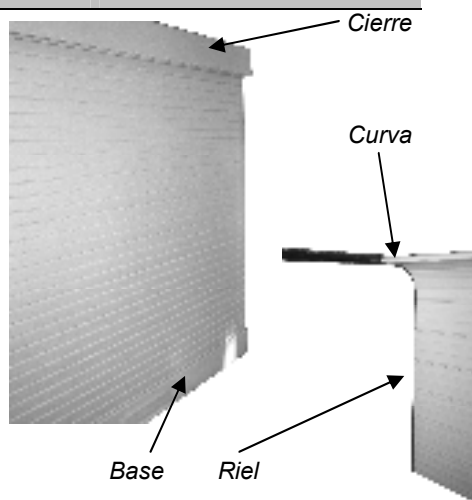

PERFILES PARA PUERTAS CORREDIZAS R-308

Código	Descripción	X Caja	U.M.
KITS ARMADOS 18 MM			
23899301	KIT 2.00 X 2.60 ANOD.NATURAL	1	C/U
23899321	KIT 2.00 X 2.60 ANOD.DORADO	1	C/U
23899341	KIT 2.00 X 2.60 EPOXI BLANCO	1	C/U
23899311	KIT 3.00 X 2.60 ANOD.NATURAL	1	C/U
23899331	KIT 3.00 X 2.60 ANOD.DORADO	1	C/U
23899351	KIT 3.00 X 2.60 EPOXI BLANCO	1	C/U

El kit se compone de cuatro ruedas, cuatro patines, cuatro perfiles manijon, un riel superior doble y un riel inferior doble y la felpa.

COMPONENTES 18 MM

2389936	SET DE RUEDAS Y PATINES	1	C/U
OBS: Incluye ruedas y patines para dos hojas			
2384045	RUEDA INFERIOR 308	12	C/U
2384046	PATIN SUPERIOR 308 NYLON	12	C/U
23840460	PATIN SUPERIOR 308 C/RUEDAS	12	C/U
2384047	RIEL SUPERIOR NATURAL X 2 MT	1	C/U
23840471	RIEL SUPERIOR NATURAL X 3 MT	1	C/U
23840470	RIEL SUPERIOR DORADO X 2 MT	1	C/U
23840472	RIEL SUPERIOR DORADO X 3 MT	1	C/U
2384049	RIEL INFERIOR NATURAL X 2 MT	1	C/U
23840491	RIEL INFERIOR NATURAL X 3 MT	1	C/U
23840490	RIEL INFERIOR DORADO X 2 MT	1	C/U
23840492	RIEL INFERIOR DORADO X 3 MT	1	C/U
2384050	PERFIL MANIJA X 2.60 NATURAL	1	C/U
23840500	PERFIL MANIJA X 2.60 ORO	1	C/U
2384052	PERFIL "U" NATURAL X 2 MT	1	C/U
23840521	PERFIL "U" NATURAL X 3 MT	1	C/U
23840520	PERFIL "U" DORADO X 2 MT	1	C/U
23840522	PERFIL "U" DORADO X 3 MT	1	C/U

OBS: Todos los componentes son para 18 mm

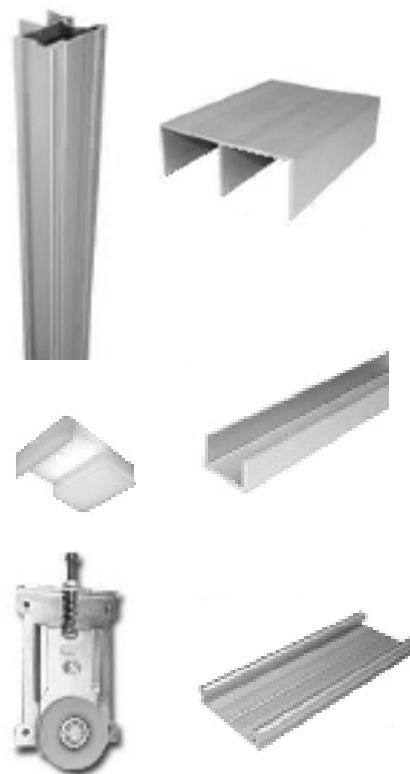

PERFILES PARA PUERTAS CORREDIZAS "LAMA"

Código	Descripción	X Caja	U.M.
3235001	KIT LAMA X 2 MTS-2 HOJAS	1	C/U
3235002	KIT LAMA X 3 MTS-2 HOJAS	1	C/U

OBS: El kit incluye: cuatro ruedas, cuatro patines
cuatro manijones, un perfil superior, un
perfil inferior y la felpa para los manijones



PERFILES PARA VITRINAS CORREDIZAS

Código	Descripción	X Caja	U.M.
8200101	RIEL INFERIOR DOBLE X 6 MTS	1	C/U
8200102	RIEL SUPERIOR DOBLE X 6 MTS	1	C/U
8200103	PERFIL "H" X 6 MTS	1	C/U
3180105	CARRITO SIMPLE	24	C/U
3180106	CARRITO DOBLE	24	C/U

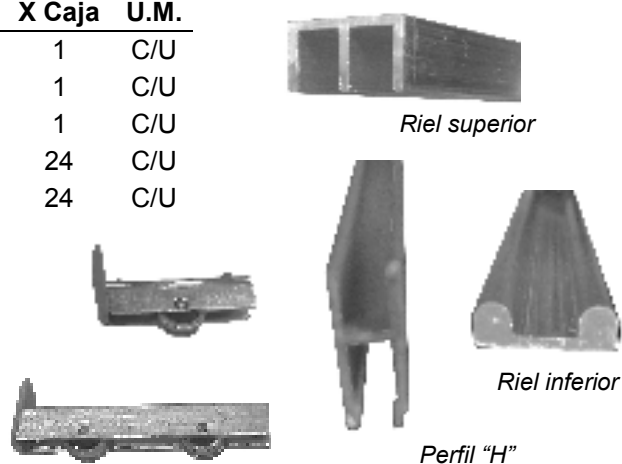

CANTO DE P.V.C. PARA PUERTA PLEGADIZA

Código	Descripción	X Caja	U.M.
2450002	CANTO "T" 10.5 MM	50	MT
2459999	TELA "GROSS" 25 MM	100	MT

OBS: El canto es color habano con tira de plata
La tela es para unión de las tabillas.
El color de la tela es marron.



TAPACANTO MELAMINICO PREENCOLADO

Código		Descripción	X rollo	U.M.
22MM	50 MM	COLOR		
4890101	4890201	BLANCO	50	MT
4890102	4890202	HAYA	50	MT
4890103	4890203	HAYA NATURAL	50	MT
4890104	4890204	CEREJEIRA	50	MT
4890105	4890205	CEDRO	50	MT
4890106	4890206	CEREZO	50	MT
4890107	4890207	WENGE	50	MT
4890108	4890208	FREZNO ABEDUL	50	MT
4890109	4890209	ALMENDRA	50	MT
4890110	4890210	NEGRO	50	MT
4890111	4890211	GRIS HUMO	50	MT
4890112	4890212	CENIZA	50	MT
4890113	4890213	GRAFITO	50	MT



4890114	4890214	AZUL	50	MT
4890115	4890215	ALUMINIO	50	MT
4890116	4890216	FREZNO NEGRO	50	MT
4890117	4890217	PERAL	50	MT

OBS: Tapatornillos en melamina en pag:145

RUEDAS PLASTICAS LIVIANAS

Código	Descripción	X Caja	U.M.
5220101	RUEDA DOBLE 38 MM C/BUJE 12 MM	1	C/U
5220103	RUEDA DOBLE 38 MM C/BASE	1	C/U
5220104	RUEDA DOBLE 38 MM C/PERNO	1	C/U

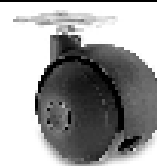

RUEDAS PLASTICAS

Código	Descripción	X Caja	U.M.
3110101	ART. 41 ESFERICA C/ R.5/16"	1	C/U
3110102	ART. 42 ESFERICA C/ R.3/8"	1	C/U
3110103	ART. 43 ESFERICA C/ PERNO ESTR.	1	C/U
3110104	ART. 44 ESFERICA C/ BASE	1	C/U
3110105	ART. 45 ESFERICA C/ R.1/4"	1	C/U
3110501	ART.101 DOBLE REF. C/ R.5/16"	1	C/U
3110502	ART.102 DOBLE REF. C/ R.3/8"	1	C/U
3110503	ART.103 DOBLE REF. C/ PERNO EST	1	C/U
3110504	ART.104 DOBLE REF. C/ BASE	1	C/U
3110505	ART.105 DOBLE REF. C/R. 1/4"	1	C/U
3110701	ART.401 DOBLE LIV. C/ R. 5/16"	1	C/U
3110702	ART.402 DOBLE LIV. C/ R. 3/8"	1	C/U
3110703	ART.403 DOBLE LIV. C/PERNO ESTR	1	C/U
3110704	ART.404 DOBLE LIV. C/ BASE	1	C/U
3110705	ART.405 DOBLE LIV.C/R. 1/4"	1	C/U
3110801	ART 501 DOBLE R.5/16"	1	C/U
3110802	ART 502 DOBLE R.3/8"	1	C/U
3110803	ART 503 DOBLE C/PERNO ESTR.	1	C/U
3110804	ART 504 DOBLE C/BASE	1	C/U
3110805	ART 505 DOBLE C/R.1/4"	1	C/U
3110808	ART 508 DOBLE C/PERNO SILLA	1	C/U
5220140	60 MM GRIS Y PLATA	1	C/U
5220141	60 MM GRIS Y PLATA C/FRENO	1	C/U
5220144	80 MM GRIS Y PLATA	1	C/U
5220145	80 MM GRIS Y PLATA C/FRENO	1	C/U



Diam.38 mm

Rosca 3/8"- 5/16"-1/4"



Diam.45 mm

Perno estriado



Diam.42 mm

Base



Diam.53 mm

Perno silla



OBS: Estas ruedas son con base

RUEDAS CON CUERPO ZAMAK

Código	Descripción	X Caja	U.M.
3110315	ART. 61 T/ "GOTA" C/ R.5/16"	1	C/U
3110316	ART. 62 T/ "GOTA" C/ R.3/8"	1	C/U
3110317	ART. 63 T/ "GOTA" C/ PERNO ESTR.	1	C/U
3110318	ART. 64 T/ "GOTA" C/ BASE	1	C/U
3110319	ART. 65 T/ "GOTA" C/ R.1/4"	1	C/U
3110601	ART.201 DOBLE C/ R.5/16"	1	C/U
3110602	ART.202 DOBLE C/ R.3/8"	1	C/U
3110603	ART.203 DOBLE C/ PERNO ESTR.	1	C/U
3110604	ART.204 DOBLE C/ BASE	1	C/U
3110605	ART.205 DOBLE C/ R.1/4"	1	C/U



Diam:35 mm



Diam:48 mm

RUEDAS PARA MESAS DISEÑOS ESPECIALES

Código	Descripción	X Caja	U.M.
5220161	MODELO D6500	1	C/U
	DIAM: 60 MM	1	C/U
	CARGA:50 KG.	1	C/U
		1	C/U
5220164	MODELO D8000 SATINADO/NEGRO	1	C/U
	DIAM:80 MM.	1	C/U
	CARGA:20 KG	1	C/U
		1	C/U
5220165	MODELO RD 65 CENTRO CALADO	1	C/U
	DIAM:65 MM	1	C/U
	CARGA:60 KG	1	C/U
		1	C/U



RUEDA CAMERA

Código	Descripción	X Caja	U.M.
5220193	38 MM BASE FIJA	1	C/U



RUEDAS DE GOMA

Código	Descripción	X Caja	U.M.
2127151	32 MM PLANA C/BASE	1	C/U
2127152	38 MM PLANA C/BASE	1	C/U
2127153	51 MM PLANA C/BASE	1	C/U
2127157	32 MM PLANA C/ROSCA 5/16"	1	C/U
2127158	38 MM PLANA C/ROSCA 3/8"	1	C/U
2127159	51 MM PLANA C/ROSCA 3/8"	1	C/U
2127180	38 MM ESFÉRICA C/BASE	1	C/U
2127181	51 MM ESFÉRICA C/BASE	1	C/U
2127182	38 MM ESFÉRICA C/ROSCA 3/8"	1	C/U
2127183	51 MM ESFÉRICA C/ROSCA 3/8"	1	C/U



RUEDAS INDUSTRIALES EN POLIPROPILENO

Código	Descripción	X Caja	U.M.
RUEDAS EN POLIPROPILENO			
3770101	GIRATORIA C/BASE 30 MM NEGRA	1	C/U
3770102	GIRATORIA C/BASE 40 MM NEGRA	1	C/U
3770103	GIRATORIA C/BASE 50 MM BLANCA	1	C/U
3770104	GIRATORIA C/BASE 75 MM BLANCA	1	C/U
3770105	GIRATORIA C/BASE 100 MM BLANCA	1	C/U
3770106	GIRATORIA C/BASE 125 MM BLANCA	1	C/U
3770201	FIJA 40 MM NEGRA	1	C/U
3770202	FIJA 50 MM BLANCA	1	C/U
3770203	FIJA 75 MM BLANCA	1	C/U
3770204	FIJA 100 MM BLANCA	1	C/U
3770205	FIJA 125 MM BLANCA	1	C/U
3770209	GIRATORIA C/ROSCA 40 MM NEGRA	1	C/U
3770210	GIRATORIA C/ROSCA 50 MM BLANCA	1	C/U
3770211	GIRATORIA C/ROSCA 75 MM BLANCA	1	C/U
3770212	GIRATORIA C/ROSCA 100 MM BLANCA	1	C/U
3770213	GIRATORIA C/ROSCA 125 MM BLANCA	1	C/U
3771101	GIRAT.C/TUBO P/SOLDAR 50 MM	1	C/U
3771102	GIRAT.C/TUBO P/SOLDAR 60 MM	1	C/U
3771103	GIRAT.C/TUBO P/SOLDAR 70 MM	1	C/U
3771104	GIRAT.C/TUBO P/SOLDAR 100 MM	1	C/U
RUEDAS CON BANDA DE GOMA			
3771001	GIRATORIA C/BASE 50 MM NEGRA	1	C/U
3771026	GIRATORIA C/BASE 50 MM GRIS	1	C/U
3771002	GIRATORIA C/BASE 75 MM GRIS	1	C/U
3771003	GIRATORIA C/BASE 100 MM GRIS	1	C/U
3771027	GIRAT.C/FRENO C/BASE 50 MM GRIS	1	C/U
3771028	GIRAT.C/FRENO C/BASE 75 MM GRIS	1	C/U
3771029	GIRAT.C/FRENO C/BASE 100 MM GRIS	1	C/U
3771006	FIJA 50 MM.C/GOMA NEGRA	1	C/U
3771007	FIJA 75 MM.C/GOMA GRIS	1	C/U
3771008	FIJA 100 MM.C/GOMA GRIS	1	C/U
3771010	GIRATORIA C/ROSCA 50 MM GRIS	1	C/U
3771011	GIRATORIA C/ROSCA 75 MM GRIS	1	C/U
3771012	GIRATORIA C/ROSCA 100 MM GRIS	1	C/U
RUEDAS PARA CAMILLAS Y CHANGOS			
3771050	GIRATORIA C/BULON 100 MM GRIS	1	C/U
3771051	GIRAT.C/FRENO C/BUL 100 MM GRIS	1	C/U



ACCESORIOS P/RUEDAS Y PATINES

Código	Descripción	X Caja	U.M.
3112001	PLAQUETA 4 AGUJ.25X25 5/16"	100	C/U
31120010	PLAQUETA 4 AGUJ.25X25 3/8"	100	C/U
3112002	PLAQUETA 2 AGUJ. 5/16"	100	C/U
3115001	BASE "U" GRANDE 15 MM	1	C/U
31150010	BASE "U" GRANDE 18 MM	1	C/U
31150012	BASE "U" GRANDE 25 MM	1	C/U
3115002	BASE "U" CHICA 15 MM	1	C/U
31150020	BASE "U" CHICA 18 MM	1	C/U
31150022	BASE "U" CHICA 25 MM	1	C/U
3115003	BASE "L"	1	C/U

OBS: Las bases son de color negro



PATINES REGULABLES

Código	Descripción	X Caja	U.M.
3116010	PATIN REGULABLE 35 MM.5/16	100	C/U
3116012	PATIN REGULABLE 35 MM.3/8	100	C/U
3116002	PATIN REGULABLE 43 MM-5/16	100	C/U
3116004	PATIN REGULABLE 43 MM-3/8	100	C/U
3116006	PATIN FIJO 60 MM-5/16	100	C/U
3116008	PATIN FIJO 60 MM-3/8	100	C/U
3115014	PATIN REGULABLE 17 MM 5/16"	100	C/U
2353450	PATIN REG.AUTOCLAVABLE	100	C/U

Con tuerca para clavar

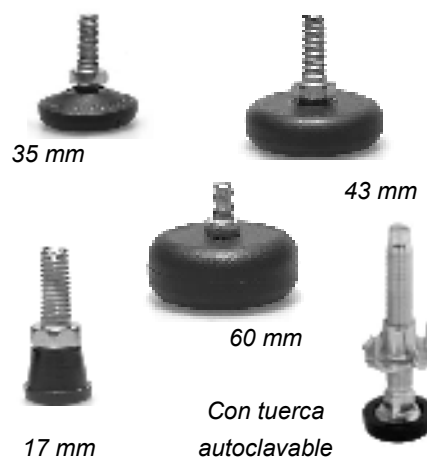

PATAS PARA MUEBLES

Código	Descripción	X Caja	U.M.
PLASTICAS			
3060201	10 CM NEGRA	50	C/U
3060202	15 CM NEGRA	50	C/U
3060205	10 CM BLANCA	50	C/U
3060206	15 CM BLANCA	50	C/U
3060210	10 CM GRIS ALUMINIO	50	C/U
3060211	15 CM GRIS ALUMINIO	50	C/U
9125020	112-132 MM	100	C/U
9125021	CLIP PARA ZOCALO DE ALUMINIO	100	C/U
9125022	CLIP PARA ZOCALO DE MADERA	100	C/U
9125024	TORNILLO DE FIJACION AL MUEBLE	100	C/U
9125023	TAPA TORNILLO DE FIJACION	100	C/U
ALUMINIO CONICAS			
2301001	10 CM.	12	C/U
2301002	15 CM.	12	C/U
2301003	20 CM.	12	C/U
2301004	25 CM.	12	C/U



ALUMINIO Y ZAMAK FORMAS DIVERSAS

23534391	ZAMAK CROMADO 115 MM	20	C/U
23534395	ZAMAK CROMADO 70 MM	20	C/U
23534396	ALUMINIO PULIDO 115 MM	20	C/U
23534392	ALUMINIO PULIDO 100 MM	20	C/U
23534393	ALUMINIO PULIDO 120 MM ANGULO	20	C/U
23531511	MANGUITO M8 PARA FIJAR PATA	20	C/U



PATINES METALICOS

Código	Descripción	X Caja	U.M.
2190404	12 MM BRONCEADO	10	CIEN
2190401	12 MM NIQUELADO	10	CIEN
2190405	15 MM BRONCEADO	10	CIEN
2190402	15 MM NIQUELADO	10	CIEN



ZAPATAS PARA MUEBLES

Código	Descripción	X Caja	U.M.
2201501	TIPO "U" 15 MM.MARRON	2.5	CIEN
2201502	TIPO "U" 18 MM.MARRON	2.5	CIEN
2201503	TIPO "U" 15 MM NEGRO	2.5	CIEN
2201504	TIPO "U" 18 MM NEGRO	2.5	CIEN
2354040	ZAPATA C/TARUGOS NEGRO	100	C/U
9125028	ZAPATA C/TARUGOS BLANCA	1	CIEN
2354043	PATIN CON CLAVOS	100	C/U
9125025	PATIN CON AGUJEROS	1	CIEN

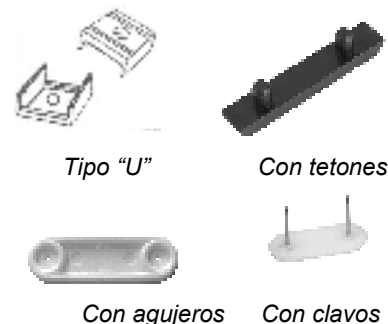

PATAS PAR MESAS Y ESCRITORIOS

Código	Descripción	X Caja	U.M.
PATAS CILÍNDRICAS ALTURA STD			
2420150	71 A 74 CM DIAM 63 NEGRA	1	C/U
2420151	71 A 74 CM DIAM 63 CROMO	1	C/U
2420155	71 A 74 CM DIAM 63 GRIS ALUMINIO	1	C/U
2420156	71 A 74 CM DIAM 89 NEGRA	1	C/U
2420157	71 A 74 CM DIAM 89 CROMO	1	C/U
2420158	71 A 74 CM DIAM 89 ALUMINIO	1	C/U

OBS: A pedido; altura 850; 1000 y 1200 mm

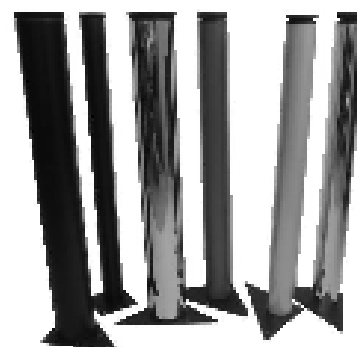

PATAS COMPONIBLES

2353453	TUBO 60 MM X ALTO 1300 MM ACERO	1	C/U
2353455	TUBO 60 MM X ALTO 1300 MM CROMO	1	C/U
2353456	PLACA DE FIJACIÓN AL MUEBLE	1	C/U
2353457	CONO DE FIJACIÓN 60 MM	1	C/U
2352324	REGATON REGULABLE 60 MM	1	C/U
2352392	RUEDA PARA PATA 60 MM	1	C/U
2352338	TUBO 80 MM X ALTO 1300 MM ACERO	1	C/U
2353471	TUBO 80 MM X ALTO 1300 MM CROMO	1	C/U
2353472	CONO DE FIJACIÓN 80 MM	1	C/U
2353473	REGATON REGULABLE 80 MM	1	C/U



ESTRUCTURAS PARA ESCRITORIOS

2420140	BASE LATERAL PARA ESCRITORIO	1	C/U
2420141	BASE CENTRAL PARA ESCRITORIO	1	C/U
2420142	PERFIL TRAVESAÑO 50X80X1000	1	C/U
2420143	SOPORTE CORREDIZO (REFUERZO)	1	C/U

OBS: El soporte corredizo es para fijar el travesañ a la tapa



DISTANCIADORES PARA VIDRIO

Código	Descripción	X Caja	U.M.
2660010	31X50	1	C/U
2660011	31X70	1	C/U
2660012	31X100	1	C/U
2660013	20X30	1	C/U
2660014	20X50	1	C/U

OBS.: Medida en mm. Diam.x Largo



FELPAS PARA PATAS DE SILLAS

Código	Descripción	X Set	U.M.
2993504	CIRCULAR 6 MM DIAM 20 MM	X9	C/U
2993505	CIRCULAR 6 MM DIAM 20 MM	X9	C/U
2993506	CIRCULAR 6 MM DIAM 32 MM	X6	C/U
2993507	CIRCULAR 6 MM DIAM 40 MM	X4	C/U
2993508	CIRCULAR 6 MM DIAM 50 MM	X4	C/U
2993509	CUADRADO 6 MM – 20 MM	X9	C/U
2993510	CUADRADO 6 MM – 30 MM	X9	C/U
2993511	CUADRADO 6 MM – 45 MM	X4	C/U

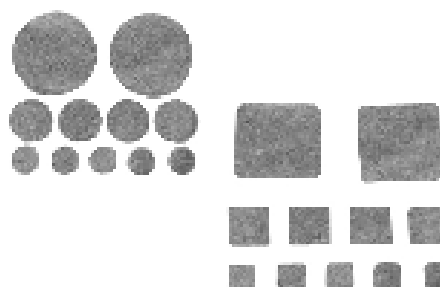

HERRAJES PARA ARMAR MUEBLES

Código	Descripción	X Caja	U.M.	
2150101	GANCHO ELASTICO HIERRO	25	JUEGO	
2150103	GANCHO LARGUERO H' CINCADO	25	JUEGO	
2150104	GANCHO PARRILLA HIERRO	25	JUEGO	
1281503	DE EMBUTIR 75 MM. (1 PIEZA)	25	JUEGO	
1281501	DE EMBUTIR 125 MM.(4 PIEZAS)	25	JUEGO	
1251502	DE EMBUTIR 150 MM.(4 PIEZAS)	25	JUEGO	
2081102	HAMBURGUES ANGULO	25	JUEGO	
3160110	ESCUADRA "W" P/MESAS Y SILLAS Incluye 1 escuadra y 1 tornillo c/tuerca	25	C/U	
2081110	CUÑA P/PLACARD CINCADO El juego es para los cuatro angulos(12 pzs)	25	JUEGO	

TORNILLOS PARA CAMAS Y CUNAS

Código	Descripción	X Caja	U.M.	
23533382	TORNILLO M6X60 EMPAVONADO	100	C/U	
235333820	TORNILLO M6X60 NIQUELADO	100	C/U	
23533384	TORNILLO 1/4X120 NEGRO	100	C/U	
23533383	CILINDRO METALICO M6	100	C/U	
2351220	CILINDRO METALICO 1/4	100	C/U	
2210506	TORNILLO B82 COMPLETO (82 MM)	50	C/U	

OBS: B82 incluye tornillo, cilindro y arandela

BULONES PARA CAMA

Código	Descripción	X Caja	U.M.	
3160102	CABEZA HEXAGONAL 8X110	4	C/U	
3160103	CABEZA HEXAGONAL 8X125	4	C/U	
3160104	CABEZA HEXAGONAL 8X140	4	C/U	
3160105	CABEZA HEXAGONAL 8X160	4	C/U	

OBS: Bulon de una pieza, en cincado amarillo

ENSAMBLADORES EMBUTIDOS

Código	Descripción	X Caja	U.M.	
9124001	PERNO ESPANSO 7X45 ROSCA DIR	1	CIEN	
9124002	PERNO ESPANSO 7X42 ROSCA M.6	1	CIEN	
9124010	CAJA ESPANSO PARA 25 MM	1	CIEN	
9124011	CAJA ESPANSO PARA 18 MM	1	CIEN	
9124012	CAJA ESPANSO PARA 15 MM	1	CIEN	
9124020	TACO NYLON ESPANSO M6	1	CIEN	

TORNILLOS DE ENSAMBLE

Código	Descripción	X Caja	U.M.	
2353332	CONFIRMAT ALLEN NEGRO 5X50	1000	C/U	
9125010	CONFIRMAT ALLEN NEGRO 7X50	10	CIEN	
2353337	CONFIRMAT ALLEN NEGRO 7X70	1000	C/U	
23531556	TAPA CONFIRMAT BLANCA	1000	C/U	
23531557	TAPA CONFIRMAT MARRON	1000	C/U	

UNIONES PARA MODULOS Y PANELES

Código	Descripción	X Caja	U.M.
2200703	PLASTICA PARA 16 MM. BLANCO	50	C/U
2200705	PLASTICA PARA 19 MM. BLANCO	50	C/U
2200704	PLASTICA PARA 16 MM. MARRON	50	C/U
2200706	PLASTICA PARA 19 MM. MARRON	50	C/U
2212010	ENSAMBLADOR "E" BRONCE 5/16	50	C/U
23533381	TORNILLO HEMBRA M4 NIQUELADO	50	C/U
23533216	UNION PARA PANELES 65 MM	20	C/U
23533217	UNION PARA PANELES 150 MM	20	C/U

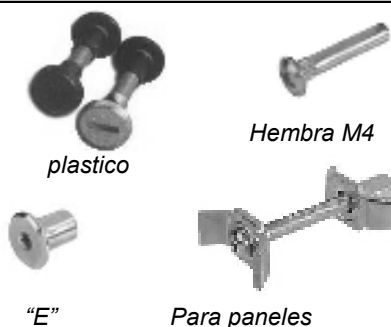

CONECTORES PLASTICOS

Código	Descripción	X Caja	U.M.
2200707	C - 26 DE DOS PIEZAS BLANCO	50	C/U
2200708	C - 26 DE DOS PIEZAS MARRON	50	C/U
22007080	C - 26 DE DOS PIEZAS NEGRO	50	C/U



ESCUADRA TRIANGULAR CON TAPA

3760109	TRANSPARENTE	2.5	CIEN
3760110	BLANCO	2.5	CIEN
3760111	ALMENDRA	2.5	CIEN
3760112	HAYA	2.5	CIEN
3760113	HAYA NATURAL	2.5	CIEN
3760114	MARFIL	2.5	CIEN
3760115	CEREZO	2.5	CIEN
3760116	MARON CLARO	2.5	CIEN
3760117	MARRON OSCURO	2.5	CIEN
3760118	NEGRO	2.5	CIEN
3760119	GRIS CLARO	2.5	CIEN



CONECTOR "RAFIX"

2353322	CAJA RAFIX MARRON	10	CIEN
23533220	CAJA RAFIX BEIGE	10	CIEN
23533221	CAJA RAFIX NEGRA	10	CIEN
23533222	CAJA RAFIX GRIS CLARO	10	CIEN
2353323	CAJA RAFIX BLANCA	10	CIEN
23533232	CAJA RAFIX "SE" MARRON	10	CIEN
23533233	CAJA RAFIX "SE" BLANCA	10	CIEN
23533234	CAJA RAFIX "SE" GRIS	10	CIEN
23533235	CAJA RAFIX "SE" NEGRA	10	CIEN
2353324	CAJA RAFIX "SE" BRUÑIDA	10	CIEN
2353325	CAJA RAFIX "SE" NIQUEL	10	CIEN
2353326	PERNO RAFIX ROSCA MADERA	10	CIEN
2353327	PERNO RAFIX MÉTRICA 5	10	CIEN
23533272	PERNO RAFIX MÉTRICA 4	10	CIEN



ESCUADRAS PLANAS

Código	Descripción	X Caja	U.M.
ESCUADRAS EN "L"			
2220110	25x10 CINCADE	24	C/U
2220111	38x10 CINCADE	24	C/U
2220112	50x10 CINCADE	24	C/U



2220113	65x10 CINCADA	24	C/U
2220114	75x13 CINCADA	24	C/U
2220115	90x15 CINCADA	24	C/U
2220116	100x17 CINCADA	24	C/U
2220117	125x20 CINCADA	24	C/U
2220118	150x20 CINCADA	12	C/U

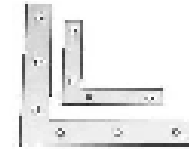

ESCUADRAS EN "T"

2220250	ESCUADRA EN "T" 70X52	24	C/U
2220251	ESCUADRA EN "T" 120X73	24	C/U

PLANCHUELAS

Código	Descripción	X Caja	U.M.
2220201	50 MM. CINCADA	60	C/U
2220202	76 MM. CINCADA	60	C/U
2220203	100 MM. CINCADA	60	C/U
2220204	125 MM. CINCADA	60	C/U
2220205	150 MM. CINCADA	60	C/U
2220206	175 MM. CINCADA	60	C/U
2220207	200 MM. CINCADA	60	C/U
2220208	250 MM. CINCADA	60	C/U
2420207	PLACA UNION 60X120 NEGRA	12	C/U
3540130	PLACA UNION 2" NEGRA	6	C/U
3540131	PLACA UNION 3" NEGRA	6	C/U
3540132	PLACA UNION 4" NEGRA	6	C/U
3540133	PLACA UNION 5" NEGRA	6	C/U
3540134	PLACA UNION 6" NEGRA	6	C/U
3540135	PLACA UNION 8" NEGRA	6	C/U

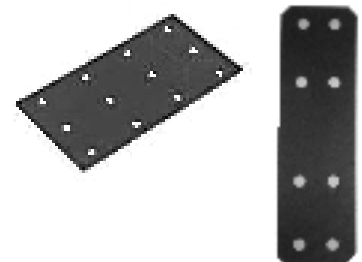

ESCUADRAS ANGULO

Código	Descripción	X Caja	U.M.
ESCUADRA ANGULO SIMPLE			
2220101	25x25 CINCADA	24	C/U
2220102	38x38 CINCADA	24	C/U
2220103	50x50 CINCADA	24	C/U
2220104	64x64 CINCADA	24	C/U
2220105	76x76 CINCADA	12	C/U
2220106	90x90 CINCADA	12	C/U
2220107	100x100 CINCADA	12	C/U
2220108	125x125 CINCADA	12	C/U
2220109	150x150 CINCADA	12	C/U
ESCUADRA ANGULO DOBLE			
2220150	35 X 35 CINCADA	24	C/U
2220151	50 X 50 CINCADA	24	C/U
2220152	65 X 65 CINCADA	24	C/U

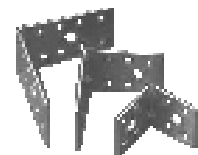

ESCUADRAS REVERSIBLES REFORZADAS

Código	Descripción	X Caja	U.M.
3380301	30X30 NEGRAS	24	C/U
3380302	40X40 NEGRAS	24	C/U
3380303	50X50 NEGRAS	24	C/U



3380304	60X60 NEGRAS	24	C/U
3380305	80X80 NEGRAS	24	C/U
3380306	100X100 NEGRAS	24	C/U
3380307	120X120 NEGRAS	24	C/U

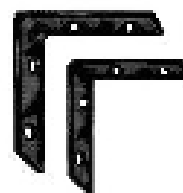

ESCUADRAS ANGULO REFORZADAS

Código	Descripción	X Caja	U.M.
ANGULOS A 90°			
3540150	A 90° 2"	6	C/U
3540151	A 90° 3"	6	C/U
3540152	A 90° 4"	6	C/U
3540153	A 90° 5"	6	C/U
3540154	A 90° 6"	6	C/U
3540155	A 90° 7"	6	C/U
3540156	A 90° 8"	6	C/U
3540157	A 90° 9"	6	C/U
3540158	A 90° 10"	6	C/U
3540159	A 90° 12"	6	C/U



ANGULOS EN "L"			
3540140	EN "L" 1 1/2" NEGRO	6	C/U
3540141	EN "L" 2" NEGRO	6	C/U
3540142	EN "L" 3" NEGRO	6	C/U
3540143	EN "L" 4" NEGRO	6	C/U
3540144	EN "L" 5" NEGRO	6	C/U
3540145	EN "L" 6" NEGRO	6	C/U
3540146	EN "L" 7" NEGRO	6	C/U
3540147	EN "L" 8" NEGRO	6	C/U
2420203	40X30X30 NEGRA	6	C/U
2212050	45X26 BLANCA	6	C/U
2212051	45X26 NEGRA	6	C/U



ESCUADRA CON NERVI

Código	Descripción	X Caja	U.M.
2200760	E - 20 (ANCHO 20 MM.)	100	C/U
2200761	E - 40 (ANCHO 40 MM.)	100	C/U

OBS.: Cincado azul

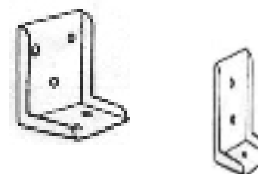

TARUGOS DE MADERA

Código	Descripción	X Caja	U.M.
4990102	6 X 30	1	MIL
4990103	6 X 35	1	MIL
4990104	6 X 40	1	MIL
4990111	8 X 30	1	MIL
4990112	8 X 35	1	MIL
4990113	8 X 40	1	MIL
4990114	8 X 45	1	MIL



4990115	8 X 50	1	MIL
4990121	10 X 30	1	MIL
4990122	10 X 35	1	MIL
4990123	10 X 40	1	MIL
4990125	10 X 45	1	MIL
4990126	10 X 50	1	MIL
4990131	12 X 30	1	MIL
4990132	12 X 35	1	MIL
4990133	12 X 40	1	MIL
4990134	12 X 45	1	MIL
4990135	12 X 50	1	MIL
4990250	12 MM.TAPON CEDRO	1	MIL
4990251	12 MM.TAPON PALO BLANCO	1	MIL
4990252	14 MM.TAPON CEDRO	1	MIL
4990253	14 MM.TAPON PALO BLANCO	1	MIL



TARUGOS EN VARILLAS

Código	Descripción	X Caja	U.M.
VARILLAS LISAS			
4990301	6 MM	25	C/U
4990303	8 MM	25	C/U
4990305	10 MM	25	C/U
4990307	12 MM	25	C/U
4990309	14 MM	25	C/U
VARILLAS ESTRIADAS			
4990320	6 MM	25	C/U
4990321	8 MM	25	C/U
4990322	10 MM	25	C/U
4990323	12 MM	25	C/U
4990324	14 MM	25	C/U

OBS: En tiras de 1 mt.



TAPATORNILLOS DE BRONCE

Codigo	Descripcion	X caja	U.M
2650201	18 MM PULIDO	100	C/U
2650202	16 MM PULIDO	100	C/U
2650203	14 MM PULIDO	100	C/U
2650304	18 MM PLATIL	100	C/U
2650305	16 MM PLATIL	100	C/U
2650306	14 MM PLATIL	100	C/U



TAPA TORNILLOS PLASTICOS

Codigo	Descripcion	X caja	U.M
PARA TORNILLO PHILLIPS			
2360401	BLANCA	10	CIEN
23604010	ALMENDRA	10	CIEN
23604011	HAYA	10	CIEN
23604012	HAYA NATURAL	10	CIEN
23604013	TOSTADO	10	CIEN
23604014	MARRON	10	CIEN
23604015	GRIS CLARO	10	CIEN
23604016	GRIS OSCURO	10	CIEN
23604017	CEREZO	10	CIEN
23604018	NEGRO	10	CIEN
CON TAPA A PRESION			
3043404	BLANCO	1	C/U
3043405	MARRON	1	C/U
3043406	NEGRO	1	C/U

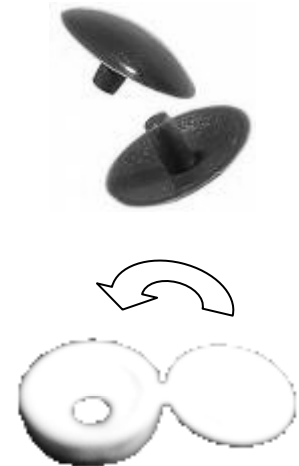

TAPA TORNILLOS AUTOADHESIVOS

Codigo	Descripcion	X caja	U.M
2360450	BLANCO	3.5	CIEN
2360451	ALMENDRA	3.5	CIEN
2360452	HAYA	3.5	CIEN
2360453	CEDRO	3.5	CIEN
2360454	CEREJEIRA	3.5	CIEN
2360455	ROBLE MORO	3.5	CIEN
2360456	GRIS HUMO	3.5	CIEN
2360457	GRAFITO	3.5	CIEN
2360458	CEREZO	3.5	CIEN
2360459	NEGRA	3.5	CIEN
2360460	WENGE	3.5	CIEN
2360461	NOGAL	3.5	CIEN
2360462	CENIZA	3.5	CIEN
2360463	BLANCO	3.5	CIEN
2360464	MAPLE	3.5	CIEN
2360465	AZUL	3.5	CIEN
2360466	ALUMINIO	3.5	CIEN
2360467	GUINDO	3.5	CIEN
2360468	HAYA NATURAL	3.5	CIEN
2360469	FRESNO NEGRO	3.5	CIEN



En cajas de 350 uds.

Con adhesivo "3M"

OBS: DIÁMETRO 14 MM HECHAS EN MELAMINA

TUERCAS CIEGAS

Codigo		Descripcion	X caja	U.M
PULIDO	PLATIL			
3011501	3011511	1/8"	100	C/U
3011502	3011512	5/32"	100	C/U
3011503	3011513	3/16"	100	C/U
3011504	3011514	1/4"	100	C/U
3011505	3011515	5/16"	100	C/U
3011506	3011516	3/8"	100	C/U



TAPATUERCAS PLASTICOS

Codigo	Descripcion	X caja	U.M
2200740	TAPATUERCA BLANCO	1	CIEN
2200741	TAPATUERCA BEIGE	1	CIEN
2200742	TAPATUERCA MARRON	1	CIEN
2200743	TAPATUERCA NEGRO	1	CIEN



TAPAORIFICIOS PLASTICOS

Codigo				Medida	X caja	U.M
Blanco	Beige	Marron	Negro	mm.		
2200747	22007470	22007471	22007472	6	5	CIEN
2200748	22007480	22007481	22007482	8	5	CIEN
2200749	22007490	22007491	22007492	10	5	CIEN
2200750	22007500	22007501	22007502	12	5	CIEN
2200751	22007510	22007511	22007512	14	5	CIEN



ARANDELAS CUNA PLASTICAS

Codigo	Descripcion	X caja	U.M
2200401	N.4 BLANCA P/CLAVO	5	CIEN
2200403	N.4 BLANCA	5	CIEN
2200404	N.4 MARRON	5	CIEN
2200405	N.6 BLANCA	5	CIEN
2200406	N.6 MARRON	5	CIEN
2200407	N.8 BLANCA	5	CIEN
2200408	N.8 MARRON	5	CIEN



TUERCA ANTIGIRO

Codigo	Descripcion	X caja	U.M
2210702	3/16"	200	C/U
2210703	3/8"	200	C/U
2210704	5/16"	200	C/U
2210705	1/4"	200	C/U



OBS: En hierro cincado amarillo

HERRAJE PORTON 340 CARRO "B" (CABEZAL FUNDIDO)



Código		Descripción	X Caja	U.M.
HIERRO	ACERO			
2380102	2380302	B3-0.60	1	C/U
2380103	2380303	B3-0.75	1	C/U
2380104	2380304	B3-0.90	1	C/U
2380105	2380305	C4-0.60	1	C/U
2380107	2380307	D4-0.75	1	C/U
2380108	2380308	D4-0.90	1	C/U
2380110	2380310	E4-0.75	1	C/U
2380111	2380311	E4-0.90	1	C/U
2380112	2380312	E5-0.75	1	C/U
2380113	2380313	E5-0.90	1	C/U
2380114	2380314	F4-0.90	1	C/U
2380115	2380315	H4-0.90	1	C/U
2380116	2380316	H5-0.90	1	C/U
2380119	2380319	I5 -0.90	1	C/U
2380121	2380321	K5-0.90	1	C/U
2380123	2380323	L5-0.90	1	C/U

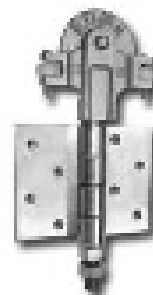

ART.340:PARA
HOJAS DE HASTA
120 KGMS.

**VER TABLA
EN PAG.151**

HERRAJE PORTON 340 CARRO "A" (CABEZAL ESTAMPADO)

Código		Descripción	X Caja	U.M.
HIERRO	ACERO			
2380001	2380050	B3-0.60	1	C/U
2380002	2380051	B3-0.75	1	C/U
2380003	2380052	B3-0.90	1	C/U
2380004	2380053	C4-0.60	1	C/U
2380005	2380054	D4-0.60	1	C/U
2380006	2380055	D4-0.75	1	C/U
2380007	2380056	D4-0.90	1	C/U
2380008	2380057	E4-0.60	1	C/U
2380009	2380058	E4-0.75	1	C/U
2380010	2380059	E4-0.90	1	C/U
2380011	2380060	E5-0.75	1	C/U
2380012	2380061	E5-0.90	1	C/U
2380013	2380062	F4-0.90	1	C/U
2380014	2380063	H4-0.90	1	C/U
2380015	2380064	H5-0.90	1	C/U
2380016	2380065	I4-0.90	1	C/U



**El herraje de porton incluye los tramos frontales superior e inferior, la curva superior e inferior y la caja de accesorios*

HERRAJE PARA PORTON "680"

Código		Descripción	X Caja	U.M.
HIERRO	ACERO			
2381101	2381301	M3-0.75	1	C/U
2381102	2381302	M3-0.90	1	C/U
2381103	2381303	P4-0.75	1	C/U
2381104	2381304	P4-0.90	1	C/U
2381105	2381305	R4-0.75	1	C/U
2381106	2381306	R4-0.90	1	C/U
2381107	2381307	R5-0.75	1	C/U

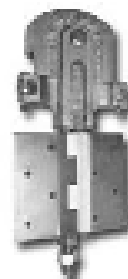

2381108	2381308	R5-0.90	1	C/U
2381109	2381309	S5-0.75	1	C/U
2381110	2381310	S5-0.90	1	C/U
2381111	2381311	S5-1.00	1	C/U
2381112	2381312	S6-0.75	1	C/U
2381113	2381313	S6-0.90	1	C/U

ART. 680: PARA
HOJAS DE HASTA
250 KGMS.



CAJAS DE ACCESORIOS 340 Y 680

Código	Descripción	X Caja	U.M.
FUNDIDO ESTAMPADO			
2381001	2381010 340 P/3 HOJAS	1	C/U
2381002	2381011 340 P/4 HOJAS	1	C/U
2381003	2381012 340 P/5 HOJAS	1	C/U
2382001	680 P/3 HOJAS	1	C/U
2382002	680 P/4 HOJAS	1	C/U
2382003	680 P/5 HOJAS	1	C/U
2382004	680 P/6 HOJAS	1	C/U

Contenido: Ejemplo 3 hojas:
2 carros intermedios
1 carro cabecero
2 bisagras intermedias
2 rolletes intermedios
1 rollete cabecero
Grampas

OBS: Por cada hoja adicional va una pieza intermedia mas.

TRAMOS SUPERIORES

Código	Descripción	X Caja	U.M.
ART 340			
2380601	CURV. SUP. 340-RADIO 60 CM.	1	C/U
2380602	CURV. SUP. 340- RADIO 75 CM.	1	C/U
2380603	CURV. SUP. 340- RADIO 90 CM.	1	C/U
2380604	CURV. SUP. 340- RADIO 1 MT.	1	C/U
2380801	TRAMO RECTO X 1.90 MT	1	C/U
23808010	TRAMO RECTO X 2.20 MT	1	C/U
23808011	TRAMO RECTO X 2.50 MT	1	C/U
23808012	TRAMO RECTO X 3.00 MT	1	C/U
ART 680			
2381601	CURV. SUP. 680-0.75 M.	1	C/U
2381602	CURV. SUP. 680-0.90 M.	1	C/U
2381603	CURV. SUP. 680-1.00 M.	1	C/U
2381801	TRAMO RECTO X 1.90 MT	1	C/U
23818010	TRAMO RECTO X 2.20 MT	1	C/U
23818011	TRAMO RECTO X 2.50 MT	1	C/U
23818012	TRAMO RECTO X 3.00 MT	1	C/U



GUIAS INFERIORES

Código	Descripción	X Caja	U.M.
CINC ACERO			
2380701	2380705 CURVA RADIO 60 CM		
2380702	2380706 CURVA RADIO 75 CM	1	C/U
2380703	2380707 CURVA RADIO 90 CM	1	C/U
2380704	2380708 CURVA RADIO 100 CM	1	C/U
2380802	2380803 RECTA X 1.90 MTS	1	C/U
23808020	23808030 RECTA X 2.20 MTS	1	C/U
23808021	23808031 RECTA X 2.50 MTS	1	C/U
23808022	23808032 RECTA X 3.00 MTS	1	C/U



COMPONENTES DEL HERRAJE ART 340

Código	Descripción	X Caja	U.M.
2380901	CARRO CABECERO FUNDIDO	1	C/U
23809010	CARRO CABECERO ESTAMPADO	1	C/U
2380902	CARRO INTERMEDIO FUNDIDO	1	C/U
23809020	CARRO INTERMEDIO ESTAMPADO	1	C/U
2380903	BISAGRA INTERMEDIA	1	C/U
2380904	ROLLETE CABECERO	1	C/U
2380905	ROLLETE INTERMEDIO	1	C/U
2380906	PERNO ROLLETE SOLO	1	C/U
2380907	GRAMPA RECTA LATERAL	1	C/U
2380908	ACOPLE RIEL (PARA UNIR RIELES)	1	C/U
2380909	RUEDA SUELTA PARA CARRO	1	C/U

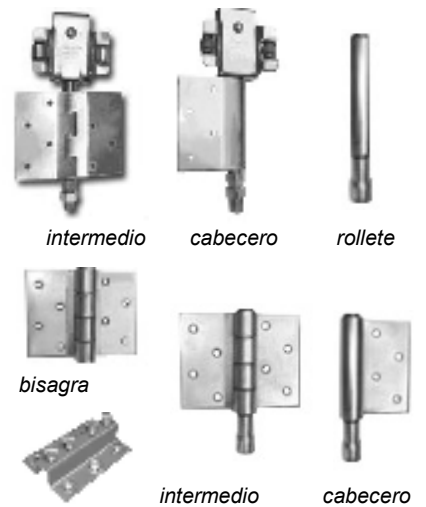

COMPONENTES DEL HERRAJE ART 680

Código	Descripción	X Caja	U.M.
2381901	CARRO CABECERO	1	C/U
2381902	CARRO INTERMEDIO	1	C/U
2381908	ROLDANA PARA CARRO	1	C/U
2381907	ACOPLE RIEL 680	1	C/U
2381906	GRAMPA RECTA LATERAL 680	1	C/U

OBS: El resto de los accesorios son los mismos que el herraje art.340

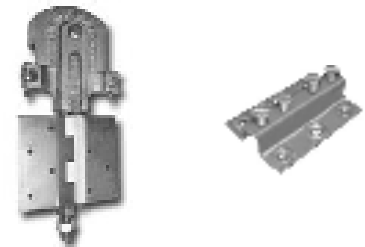

HERRAJES PARA PORTON BATIENTE

Código	Descripción	X Caja	U.M.
2386007	BISAGRA DOBLE ART.42	1	JGO.
2386006	BISAGRA SUPERIOR ART.41	1	C/U
2386005	ROTULA Y BISAGRA ART.40	1	JGO.
2386008	ROTULA INFERIOR ART.43	1	C/U
2386009	PIVOT REGULABLE C/RUL ART 44	1	C/U
2386010	PIVOT Y ROTULA C/RUL ART 45	1	JGO.
2386011	ROTULA C/RUL CONICO ART 46	1	C/U

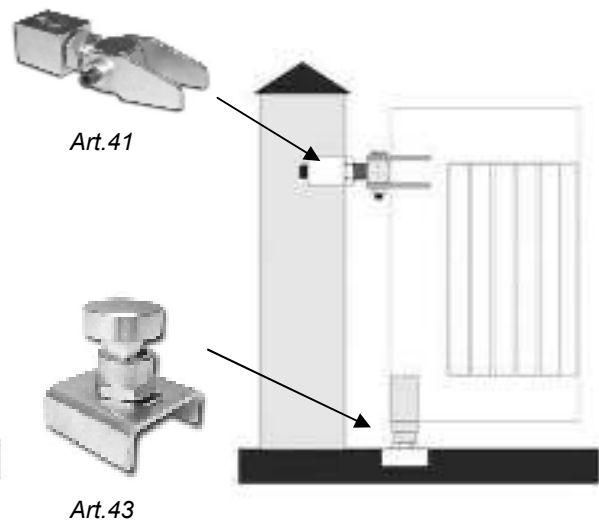
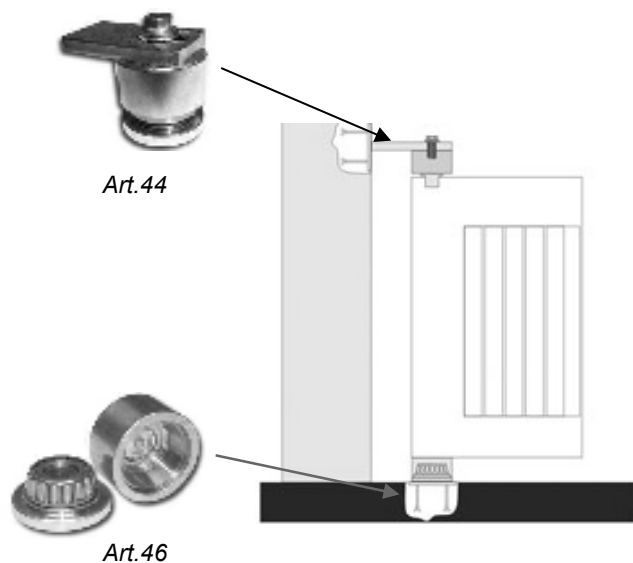
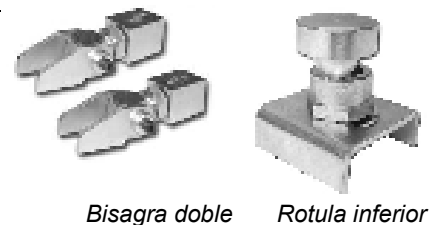



HERRAJE LEVADIZO ART. 230

Código	Descripción	X Caja	U.M.
2382101	ROLDANA FIJA PARA MADERA	1	C/U
2382102	ROLDANA FIJA PARA METAL.	1	C/U
2382103	ROLDANA MOVIL PARA MADERA	1	C/U
2382104	ROLDANA MOVIL PARA METAL	1	C/U

OBS: Kit de accesorios para porton levadizo:
2 roldanas, dos rulemanes, 2 pernos, guías laterales

2382112	BASTIDOR COMPLETO 2400x2200	1	C/U
2380116	BASTIDOR COMPLETO 2700x2200	1	C/U

OBS: Se provee cortado en angulo, para soldar

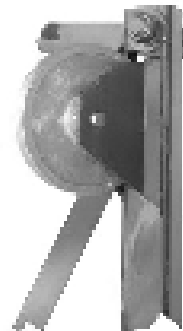

HERRAJES SUELTOS PARA LEVADIZO

Código	Descripción	X Caja	U.M.
2382213	CABLE DE ACERO	1	MT
2382207	HORQUILLA Y ROLDANA	1	C/U
2382212	PRENSA CABLE	1	C/U
2382205	PIEZA INTERMEDIA PARA MADERA	1	C/U
23822050	PIEZA INTERMEDIA PARA METAL	1	C/U
2382206	PORTA ROLDANA	1	C/U
2382209	PIEZA SUJETA CABLE P/METAL	1	C/U
23822090	PIEZA SUJETA CABLE P/MADERA	1	C/U
2382208	ROLDANA "ROMA" DE ALUMINIO	1	C/U
3840910	ROLDANA H"100 MM C/RULEMÁN	1	C/U
3840911	ROLDANA H"150 MM C/RULEMAN	1	C/U



Roldana móvil



Roldana fija



TABLA ORIENTATIVA PARA LA SELECCIÓN DE HERRAJE DE PORTON
Para portones de hasta 120kg. por hoja (ART.340 A-B)

Cant. Hoja	Luz de Abert.	Modelo a Pedir y Curva	Mochetas hasta	Med Tramos Lat-Fron
3	2.23-2.65	B-3-0.75	0.40	1.90-1.90
3	2.27-2.80	B-3-0.90	0.45	1.90-1.90
4	2.50-2.60	C-4-0.60	0.35	2.20-2.20
4	2.53-2.95	D-4-0.75	0.40	2.20-2.20
4	2.57-2.95	D-4-0.90	0.45	2.20-2.20
4	2.80-3.20	E-4-0.75	0.40	2.50-2.50
4	2.85-3.30	E-4-0.90	0.45	2.50-2.50
5	2.80-3.05	E-5-0.60	0.35	2.50-2.50
5	2.80-3.20	E-5-0.75	0.40	2.50-2.50
5	2.87-3.25	E-5-0.90	0.45	2.50-2.50
4	3.37-3.55	F-4-0.90	0.45	3.00-2.50
4	3.35-3.75	H-4-0.90	0.45	3.00-3.00
5	3.37-3.85	H-5-0.90	0.45	3.00-3.00
5	4.15-4.55	I-5-0.90	0.45	3.80-3.80
5	4.75-5.15	K-5-0.90	0.45	4.40-4.40
5	5.35-5.75	L-5-0.90	0.45	5.00-5.00

Para portones de hasta 250kg. por hoja (ART.680)

Cant. Hoja	Luz de Abert.	Modelo a Pedir y Curva	Mochetas hasta	Med Tramos Lat-Fron
3	2.23-2.65	M-3-0.75	0.40	1.90-1.90
3	2.27-2.80	M-3-0.90	0.45	1.90-1.90
4	2.80-3.25	P-4-0.75	0.40	2.50-2.50
4	2.85-3.40	P-4-0.90	0.45	2.50-2.50
4	3.10-3.75	R-4-0.75	0.40	3.00-3.00
4	3.60-3.90	R-4-0.90	0.45	3.00-3.00
5	3.18-3.75	R-5-0.75	0.40	3.00-3.00
5	3.37-3.90	R-5-0.90	0.45	3.00-3.00
5	3.55-4.65	S-5-0.75	0.40	3.80-3.80
5	3.70-4.80	S-5-0.90	0.45	3.80-3.80
6	4.00-4.80	S-6-0.75	0.40	3.80-3.80
6	4.45-4.80	S-6-0.90	0.45	3.80-3.80

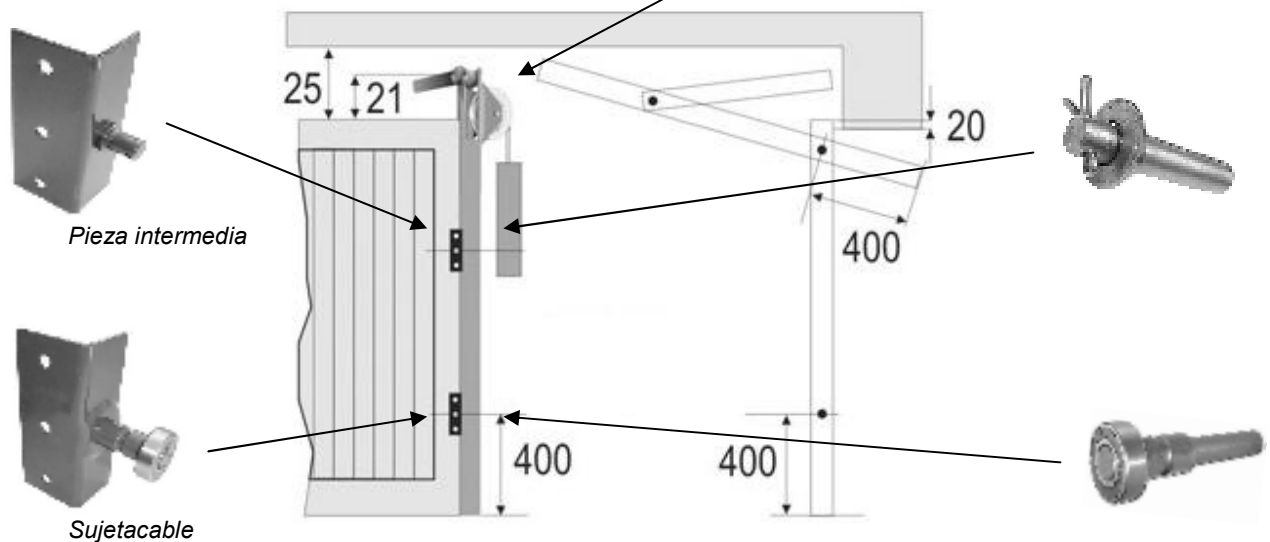
ATENCIÓN: La luz de abertura máxima corresponde a la mocheta mínima, asimismo, la mocheta máxima corresponde a la luz de abertura Mínima.

Para colocar el herraje adecuado, lo primero a tener en cuenta es el espacio que disponemos para la curva, que es el ancho de la primer hoja más el marco, más la mocheta. A ese dato habrá que restarle 10 ó 13 cmts (según sea herraje liviano o pesado) y obtendremos el espacio real disponible para la curva. Teniendo en cuenta entonces las medidas existentes de radios de curvas, colocaremos la medida inmediatamente inferior al dato obtenido. Por ej: si tenemos hoja de 80 cm, marco de 5 cm y mocheta de 20; disponemos de 105 cm menos 10 cm (si es porton liviano) lo que arroja 95 cm. Para este caso entonces cabrá colocar una curva de radio 90 que es la de medida inferior mas cercana al dato obtenido. De manera parecida calculamos los tramos rectos, que serán de la medida inmediatamente superior a la disponible una vez colocada la curva. Siguiendo el mismo ejemplo, si teníamos 95 para la curva y colocamos la de radio 90, quedan libres 5 cmts; más las dos hojas de 80 cm, nos da una necesidad de 165 cm, con lo cual el tramo recto a colocar será de 1.90 mts. que es el inmediato superior a la medida obtenida.

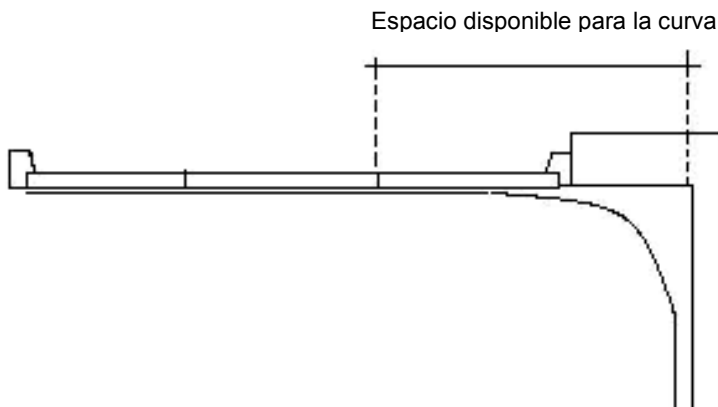

RUEDAS CON RODILLO HIERRO

Código		Descripción	X Caja	U.M.
"U"	"V"			
1190401	1190411	40 MM.	1	C/U
1190402	1190412	50 MM.	1	C/U
1190403	1190413	60 MM.	1	C/U
1190404	1190414	75 MM.	1	C/U
1190405	1190415	90 MM.	1	C/U
1190406	1190416	105 MM.	1	C/U
1190407	1190417	120 MM.	1	C/U

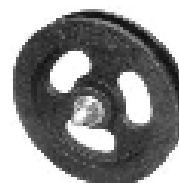

RUEDAS CON UN RULEMAN ACERO TORNEADO

Código	Descripción		X Caja	U.M.
9041201	50 MM	CANAL "V"	1	C/U
9041202	60 MM	CANAL "V"	1	C/U
9041203	80 MM	CANAL "V"	1	C/U
9041204	100 MM	CANAL "V"	1	C/U
9041205	120 MM	CANAL "V"	1	C/U
	OBS.:	HIERRO CINCADO AMARILLO	1	C/U



RUEDAS CON UN RULEMAN HIERRO

Código		Descripción	X Caja	U.M.
"U"	"V"			
3840901	3840905	60 MM	1	C/U
3840902	3840906	75 MM.	1	C/U
3840903	3840907	105 MM.	1	C/U
3840904	3840908	120 MM	1	C/U
3201510	32015100	150 MM.	1	C/U
3201511	32015110	180 MM.	1	C/U

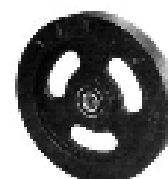

RUEDAS CON DOS RULEMANES HIERRO

Código		Descripción	X Caja	U.M.
"U"	"V"			
3201520	3201530	100 MM.	1	C/U
3201522	3201532	120 MM.	1	C/U
3201524	3201534	150 MM.	1	C/U
3201525	3201535	180 MM.	1	C/U
3201526	3201536	210 MM.	1	C/U
3201527	3201537	250 MM.	1	C/U
3201528	3201538	300 MM.	1	C/U



RUEDAS CON UN RULEMAN "QUITYPON"

Código	Descripción		X Caja	U.M.
2385510	90 MM	CINCADA	1	C/U
2385512	120 MM	CINCADA	1	C/U

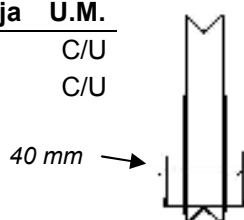

GRAMPAS PARA RUEDAS

Código	Descripción	X Caja	U.M.
1281001	GRAMPA PARA RUEDA 30/40	1	C/U
1281002	GRAMPA PARA RUEDA 50/60	1	C/U
1281003	GRAMPA PARA RUEDA 75/90	1	C/U
1281004	GRAMPA PARA RUEDA 105/120	1	C/U

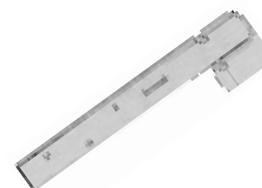

TORTUGAS DE FUNDICION

Código	Descripción	X Caja	U.M.
1190301	N°1 - 55 MM.	1	C/U
1190302	N°2 - 72 MM.	1	C/U
1190303	N°3 - 87 MM.	1	C/U
1190304	N°4 - 94 MM.	1	C/U
1190305	N°5 - 95 MM.	1	C/U
1190306	N°6 - 110 MM.	1	C/U
1190307	N°7 - 115 MM.	1	C/U
1190308	PARA ATORNILLAR BRONCE 48 MM	1	C/U
1190310	PARA ATORNILLAR HIERRO 55 MM	1	C/U



GUIA PARA PORTON CORREDIZO

Código	Descripción	X Caja	U.M.
3840201	RODILLO SIMPLE CON HORQUILLA	1	C/U
2720180	RULEMÁN 40 MM C/PERNO	1	C/U
2389970	REGULABLE – DOS RODILLOS	1	C/U
2389971	REGULABLE – CUATRO RODILLOS	1	C/U

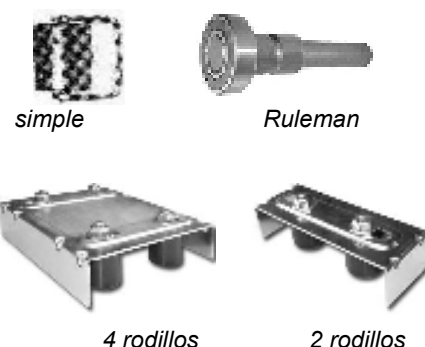

EQUIPOS AUTOMATICOS "TRACTOR"

Código	Descripción	X Caja	U.M.
CORREDIZOS			
2570101	CORREDIZO 500 KG PIÑON 13 DTES	1	KIT
2570103	CORREDIZO 800 KG PIÑON 13 DTES	1	KIT

OBS: El kit incluye: accionador, dos controles y tres mts de cremallera

Código	Descripción	X Caja	U.M.
LEVADIZO			
2570110	LEVADIZO	1	KIT

OBS: El kit incluye: accionador, dos controles y brazo telescópico

Código	Descripción	X Caja	U.M.
COMPONENTES			
2570115	CREMALLERA 6 MM PARA 500 KG	1	MT.
2570116	CREMALLERA 12MM PARA 800 KG	1	MT.
2570117	PERNO P/FIJAR CREMALLERA	1	C/U
2570120	CONTROL REMOTO ADICIONAL	1	C/U
2570121	BRAZO PARA PORTON LEVADIZO	1	C/U

OBS: La cremallera viene en modulos de 1 mt



CARROS PARA PUERTAS CORREDIZAS



Código	Descripción	Ruedas	Diam.	Riel	U.M.
2382629	ART.N 130/0	1 bis	25	136	C/U
2382630	ART.N 130/7	1 bis	25	136	C/U
2382631	ART.N 130/14	1 bis	25	136	C/U
2382638	ART.N 110/0	2 bis	25	136	C/U
2382639	ART.N 110/7	2 bis	25	136	C/U
2382640	ART.N 110/14	2 bis	25	136	C/U
2382301	ART.A 140	1+2 bis	32/25	140	C/U
2382501	ART.A 142	1 bis	25	142	C/U
2382601	ART.N 142	1 bis	25	142	C/U
2382502	ART.A 144	1 bis	25	142	C/U
2382602	ART.N 144	1 bis	25	142	C/U
2382302	ART.A 146	2 bis	25	142	C/U
2382404	ART.N 146	2 bis	25	142	C/U
2382303	ART.A 154	2 bis	25	164bis	C/U
2382405	ART.N 154	2 bis	25	164bis	C/U
2382306	ART.A 158	2 plana	25	164	C/U
2382408	ART.N 158	2 plana	25	164	C/U
2382305	ART.A 156	4 bis	25	164bis	C/U
2382407	ART.N 156	4 bis	25	164bis	C/U
2382307	ART.A 160	4 plana	25	164	C/U
2382410	ART.N 160	4 plana	25	164	C/U
2382308	ART.A 162	2 plana	25	164	C/U
2382411	ART.N 162	2 plana	25	164	C/U
2382309	ART.A 162 BIS	2 bis	25	164bis	C/U
2382412	ART.N 162 BIS	2 bis	25	164bis	C/U
2382310	ART.A 164	4 plana	25	164	C/U
2382415	ART.N 164	4 plana	25	164	C/U
2382311	ART.A 164 BIS	4 bis	25	164bis	C/U
2382416	ART.N 164 BIS	4 bis	25	164bis	C/U
2382313	ART.A 166	2 plana	20	166	C/U
2382418	ART.N 166	2 plana	20	166	C/U
2382314	ART.A 166 BIS	2 bis	20	166bis	C/U
2382419	ART.N 166 BIS	2 bis	20	166bis	C/U
2382430	ART.N 166 especial	2 plana	20	--	C/U
2382315	ART.A 168	4 plana	20	166	C/U
2382420	ART.N 168	4 plana	20	166	C/U
2382316	ART.A 168 BIS	4 bis	20	166bis	C/U
2382421	ART.N 168 BIS	4 bis	20	166bis	C/U
2382317	ART.A 170	4 plana	32	170	C/U
2382424	ART.N 170	4 plana	32	170	C/U
2382318	ART.A 170 bis	4 bis	32	170bis	C/U
2382425	ART.N 170 BIS	4 bis	32	170bis	C/U
2382530	ART.A 576	2 plana	32	170	C/U
2382531	ART A 576 BIS	2 bis	32	170bis	C/U
2382319	ART.A 172	4 plana	38	172	C/U
2382320	ART.A 174	4 plana	45	174	C/U
2382321	ART.A 180 bis	4 bis	55	180bis	C/U

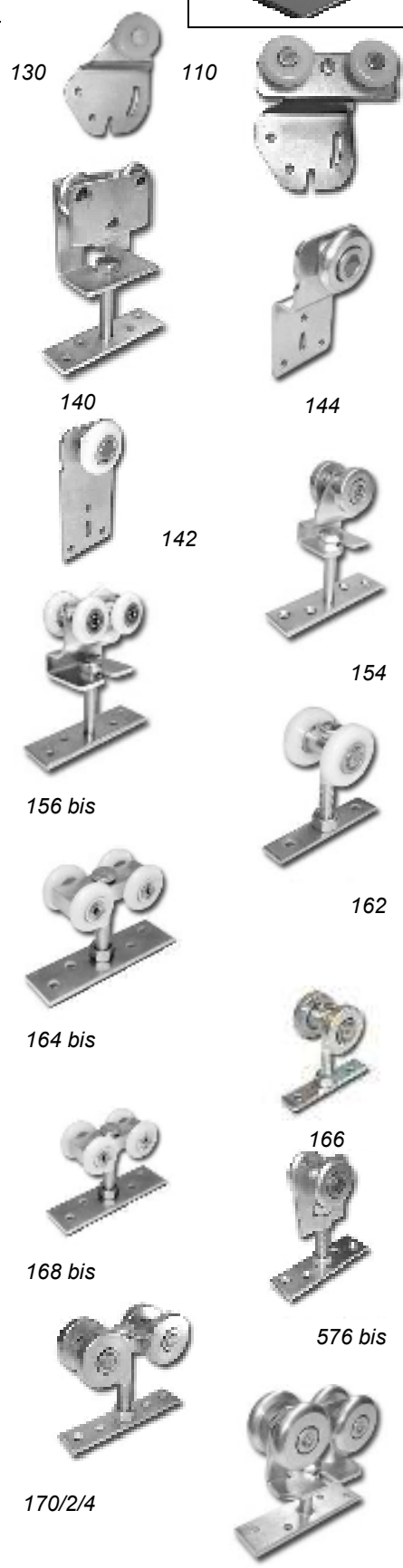

OBS.: Bis=canto redondo / 166 especial va con riel de aluminio (no disponible)

180 bis

ACCESORIOS PARA CARROS

Código	Descripción	X Caja	U.M.
2382902	PLANCHUELA P/CARRO 164	50	C/U
2382901	PLANCHUELA P/CARRO 168	50	C/U
2382903	PLANCHUELA P/CARRO 170	50	C/U



RIELES PARA CORREDIZAS

Código	Descripción	Medida	X Caja	U.M.
2383102	RIEL SUP. 136 CINCADO		1	MT.
2383104	RIEL SUP. 140	53X21	1	MT.
2383105	RIEL SUP. 142	28X14	1	MT.
2383111	RIEL SUP. 164	30X30	1	MT.
2383112	RIEL SUP. 164 bis	30X36	1	MT.
2383114	RIEL SUP. 166	25X29	1	MT.
2383115	RIEL SUP. 166 bis	24X30	1	MT.
2383116	RIEL SUP. 170	38X43	1	MT.
2383117	RIEL SUP. 170 bis	38X44	1	MT.
2383119	RIEL SUP. 172	47X50	1	MT.
2383120	RIEL SUP. 174	55X55	1	MT.
2383121	RIEL SUP. 180 bis	65X57	1	MT.



136



140

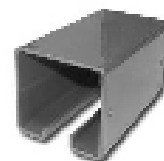

Riel plano



Riel bis.

OBS: TIRAS DE 2/3 Y 6 MTS. 170/2/4 Y 180 SOLO DE 6 MT

LA MEDIDA INDICADA CORRESPONDE A ALTO X ANCHO (EN MM.)

ACCESORIOS PARA RIELES

Código	Descripción	X Caja	U.M.
2382912	SOPORTE RIEL 164	50	C/U
2382911	SOPORTE RIEL 168	50	C/U
2382913	SOPORTE RIEL 170	50	C/U
2382904	TOPE RIEL 140	50	C/U
2382905	TOPE RIEL 142	50	C/U
2382908	TOPE RIEL 164	50	C/U
2382907	TOPE RIEL 168	50	C/U
2382909	TOPE RIEL 170	50	C/U



soporte



Tope 140



Tope 168-164-170

HERRAJES PARA GUIADO INFERIOR

Código	Descripción	X Caja	U.M.
2382930	RIEL "U" 12 MM HIERRO	1	MT.
2382933	RIEL "U" 12 MM ACERO	1	MT.
OBS: En tiras de 2 y 3 mts.			
2382918	GUIA BRONCE FUNDIDO	50	C/U
2382916	GUIA HIERRO ESTAMPADO	50	C/U
2382914	GUIA NYLON CHICA	50	C/U
2382915	GUIA NYLON GRANDE	50	C/U
2382919	GUÍA REGULABLE 136	50	C/U
2383001	ROLLETE CENTRAL N°12 NYLON	50	C/U
2383003	ROLLETE CENTRAL N°21 CINCADO	50	C/U
2383005	ROLLETE CENTRAL N°21 NYLON	50	C/U
2383002	ROLLETE DE CANTO N°12 NYLON	50	C/U
2383004	ROLLETE DE CANTO N°21 CINCADO	50	C/U
2383006	ROLLETE DE CANTO N°21 NYLON	50	C/U



Guía nylon



Rollete de centro



rollete de canto





CARROS PORTACABLE

Código	Descripción	X Caja	U.M.
2382350	CARRO ART 530 (CON RIEL 164 BIS)	1	C/U
2382351	CARRO ART 531 (CON RIEL 164 BIS)	1	C/U
2382352	CARRO ART 532 (CON RIEL 170 BIS)	1	C/U
2382353	CARRO ART 533 (CON RIEL 170 BIS)	1	C/U
2382354	TOPE ART 534 (P/AMBOS RIELES)	1	C/U

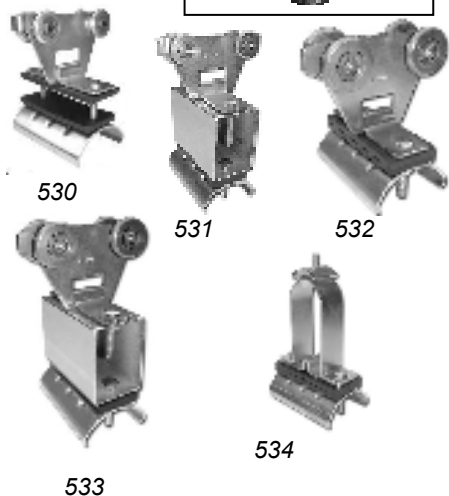

HERRAJES PARA CAMIONES

Código	Descripción	X Caja	U.M.
--------	-------------	--------	------

HERRAJES PARA LONAS

2383310	HEBILLA TENSORA PARA LONA	1	C/U
2383311	GANCHO ALAMBRE P/HEBILLA 501	1	C/U
23833110	GANCHO CHAPA P/HEBILLA 502	1	C/U
23833111	PLACA AJUSTABLE P/HEBILLA 503	1	C/U
2383312	CRIQUE PARA TENSAR LONA	1	C/U
2383314	BARRA TENSORA X 2.80	1	C/U
2383315	BARRA TENSORA X 3.60	1	C/U
2383316	ACOPLE INFERIOR PARA BARRA	1	C/U
2383318	ACOPLE SUPERIOR PARA BARRA	1	C/U
2383305	CARRO A-525 BIS 2 RUEDAS 25 MM	1	C/U
23833050	CARRO A-524 BIS 4 RUEDAS 25 MM	1	C/U
2383306	CARRO A-572 BIS 2 RUEDAS 32 MM	1	C/U
2383308	CARRO A-574 BIS 4 RUEDAS 32 MM	1	C/U
2383113	RIEL 164 BIS GALVANIZADO	6	MT
23831170	RIEL 170 BIS GALVANIZADO	6	MT



HERRAJES PARA SUJECCION DE CARGAS

2383319	BROCHE TERMINAL MODELO "E"	1	C/U
2383320	PERFIL MODELO "E" X 2.00 MT	1	C/U
2383321	ACOPLE MODELO "E"	1	C/U
2383322	SOPORTE CUNA MODELO "E"	1	C/U

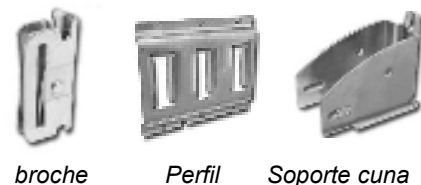



TABLA DE RESISTENCIA DE LOS CARROS

CARRO	UTILIZA RIEL	P/ HOJAS HASTA (Kg)	CARRO	UTILIZA RIEL	P/ HOJAS HASTA (Kg)
164 BIS	164 BIS	80	156	164 BIS	90
166	168	60	158	164	60
166 BIS	168 BIS	60	160	164	90
170	170	150	154	164 BIS	60
170 BIS	170 BIS	150	168/168 BIS	168/168 BIS	60
172	172	200	140	140	120
174	174	300	142	142	30
180	180	400	164	164	80

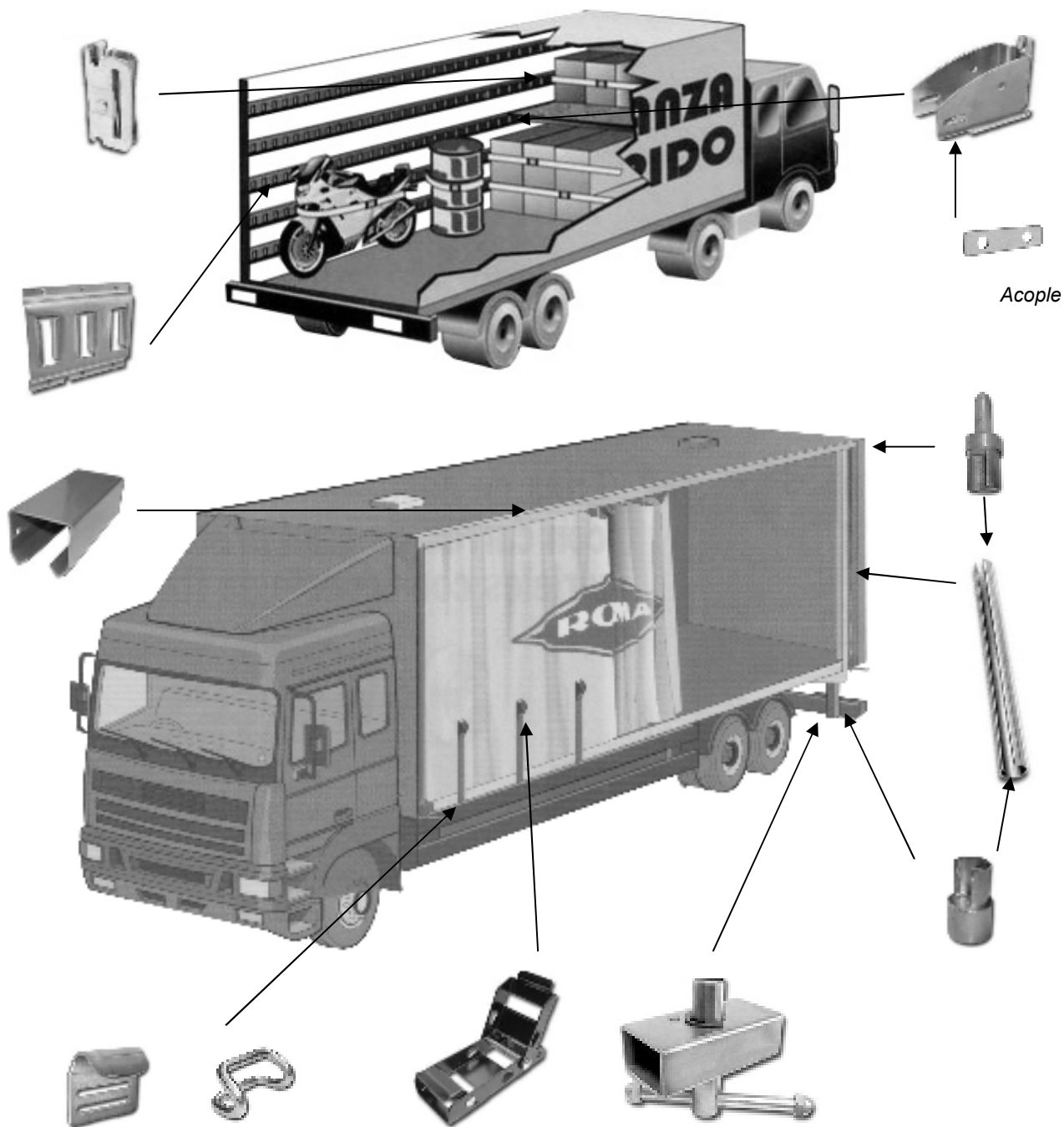

RUEDAS DE EMBUTIR

Código		Descripción	X Caja	U.M.
NYLON	ACERO	Diametro y tipo		
2383404	2383402	25 C	50	C/U
2383403	2383401	25 P	50	C/U
2383452	2383451	25 C CAJA REFORZ.	50	C/U
2383453	2383450	25 P CAJA REFORZ.	50	C/U
2383405	23834050	27 C	50	C/U
2383509	---	27 D (SIN RULEMAN)	50	C/U
2383412	2383410	32 C	50	C/U
23834120	----	32 C CANAL REDONDO	50	C/U
2383411	2383409	32 P	50	C/U
23834110	----	32 P CANTO REDONDO	50	C/U
2383416	2383414	38 C	50	C/U
23834160	----	38 C BLINDADA	50	C/U
23834161	----	38 C CANAL REDONDO	50	C/U
2383415	2383413	38 P	50	C/U
2383421	2383418	45 C.7 MM	50	C/U
23834210	23834180	45 C 7 MM CANAL RED.	50	C/U
2383422	2383419	45 C.8.5.	50	C/U
2383420	2383417	45 P	50	C/U
2383510	---	45 D (SIN RULEMAN)	50	C/U
2383428	2383425	60 C.13 MM	50	C/U
2383427	2383424	60 C.9 MM	50	C/U
23834270	---	60 C.9 MM CANAL RED.	50	C/U
2383426	2383423	60 P	50	C/U

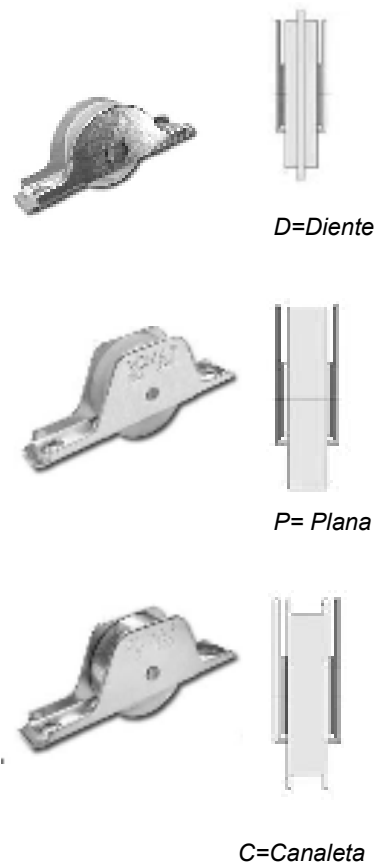

RUEDAS DE APLICAR

Código		Descripción	X Caja	U.M.
NYLON	ACERO			
2383500	2383499	301 – 25 MM	50	C/U
2383502	2383501	302 – 25 MM	50	C/U
2383504	2383503	303 – 32 MM	50	C/U
2384045	---	308 (P/KIT PLACARD)	12	C/U
2384063	---	520 (P/KIT PLACARD)	12	C/U

OBS: EN 301/2/3 SE INCLUYE LA GUIA

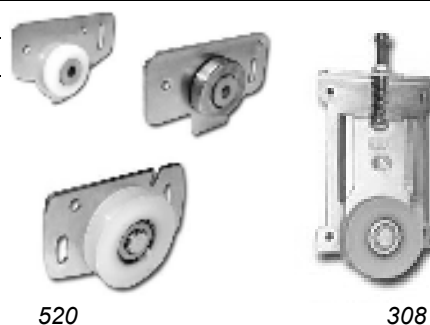

RUEDAS DE MEDIO EMBUTIR

Código	Descripción	X Caja	U.M.
2383505	C/RULEMÁN N 325 C	50	C/U
2383506	C/RULEMÁN N 325 P	50	C/U
2383507	C/RULEMÁN N 327 C	50	C/U
2383508	SIN RULEMÁN N 327 D	50	C/U



RUEDA PLASTICA DE MEDIO EMBUTIR

Código	Descripción	X Caja	U.M.
2515050	RUEDA PLASTICA C/GUIA	100	C/U
2515051	GUIA SUPERIOR REGULABLE	100	C/U
2515055	RUEDA PLASTICA REGULABLE	100	C/U
2450090	RIEL PLASTICO "U" x 3 MT BLANCO	1	C/U



2450091	RIEL PLASTICO "U" x 3 MT BEIGE	1	C/U
2450092	RIEL PLASTICO "U" x 3 MT MARRON	1	C/U
2450093	RIEL PLASTICO "U" x 3 MT NEGRO	1	C/U

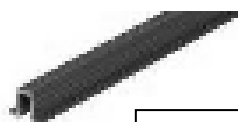

RUEDAS SOLAS CON RULEMAN

Código		Descripción	X Caja	U.M.
NYLON	ACERO	Diametro y tipo		
2383802	2383801	20 P	50	C/U
2383902	2383901	20 PS	50	C/U
2384002	2384001	25 C	50	C/U
2383804	2383803	25 P	50	C/U
2383904	2383903	25 PS	50	C/U
23840030	2384003	27 C	50	C/U
2384005	2384004	32 C	50	C/U
2383807	2383806	32 P	50	C/U
2383906	2383905	32 PS	50	C/U
2384007	2384006	38 C	50	C/U
2383809	2383808	38 P	50	C/U
2384009	2384008	45 C.7.	50	C/U
2384011	2384010	45 C.8.5	50	C/U
2383811	2383810	45 P	50	C/U
2384015	2384014	60 C.13.	50	C/U
2384013	2384012	60 C.9.	50	C/U
2383813	2383812	60 P	50	C/U

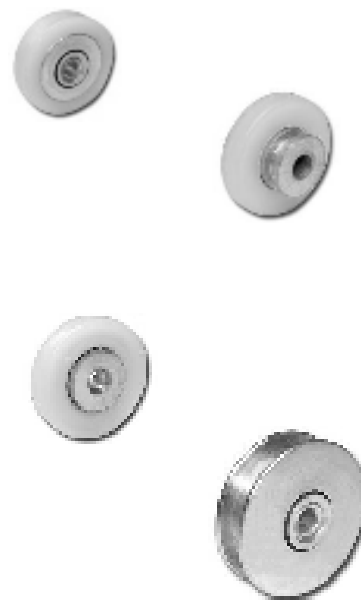

OBS: P=plano C=con canaleta PS=plano con saliente

ESTABILIZADORES PARA VENTANAS

Código	Descripción	X Caja	U.M.
2383301	ESTABILIZADOR CON RESORTE	1	C/U



CARRITOS PARA VENTANAS DE ALUMINIO

Código	Descripción	X Caja	U.M.
2410771	CARRO P/ALUM SIMPLE P/VENTANA	1	C/U
2410772	CARRO P/ALUM DOBLE VENTANA	1	C/U



RIELES PARA PUERTAS CORREDIZAS

Código		Descripción		X Caja	U.M.
CINCADO	BRONCE	ACERO	TIPO Y LARGO		
2021101	2021109	2021105	25 X 2 MTS	1	C/U
2021102	2021110	2021106	32/38 X 2 MTS	1	C/U
2021104	2021112	2021108	45 X 2 MTS	1	C/U
20211010	20211090	20211050	25 X 3 MTS	1	C/U
20211020	20211100	20211060	32/38 X 3 MTS	1	C/U
20211040	20211120	20211080	45 X 3 MTS	1	C/U



OBS: 25,32/38 Y 45 se refiere al tamaño de rueda que va en el riel.



SISTEMAS PARA PUERTAS CORREDIZAS DE PLACARD

Código	Descripción	X Caja	U.M.
SISTEMA 130 COLGANTE			
2389950	KIT 130 X 2 MTS	1	C/U
2389951	KIT 130 X 3 MTS	1	C/U
OBS: Incluye set de accesorios, un riel superior y una guía inferior			
2389952	SET 130 (4 carros y 1 guía)	1	C/U
2389953	RIEL 136 GALVANIZADO X 2 MTS	1	C/U
2389954	RIEL 136 GALVANIZADO X 3 MTS	1	C/U
2382919	GUIA INFERIOR REGULABLE	1	C/U
SITEMA 520 (para puertas hasta 52 kg)			
2389940	KIT 520 PARA 2 MTS	1	C/U
2389941	KIT 520 PARA 3 MTS	1	C/U
OBS: Incluye 1 set de acc, dos rieles superiores y dos inferiores			
2389942	SET 520 (4 RUEDAS Y 4 PATINES)	1	C/U
COMPONENTES SUELTOS			
2384063	RUEDA 520	12	C/U
2384064	PATIN SUPERIOR 520	12	C/U
2384065	RIEL SUPERIOR 520 X 2 MTS	10	C/U
2384067	RIEL SUPERIOR 520 X 3 MTS	10	C/U
2384066	RIEL INFERIOR 520 X 2 MTS	10	C/U
2384068	RIEL INFERIOR 520 X 3 MTS	10	C/U
SISTEMA 308 – PARA 18 MM 2 HOJAS			
23899301	KIT 308 2.00 X 2.60 ANOD.NATURAL	1	C/U
23899321	KIT 308 2.00 X 2.60 ANOD.DORADO	1	C/U
23899341	KIT 308 2.00 X 2.60 EPOXI BLANCO	1	C/U
23899311	KIT 308 3.00 X 2.60 ANOD.NATURAL	1	C/U
23899331	KIT 308 3.00 X 2.60 ANOD.DORADO	1	C/U
23899351	KIT 308 3.00 X 2.60 EPOXI BLANCO	1	C/U
OBS: Incluye set de acc, un riel superior, uno inferior y 4 manijones			
2384044	SET 308 (4 RUEDAS Y 4 PATINES)	1	C/U
COMPONENTES SUELTOS			
2384045	RUEDA INFERIOR 308	12	C/U
2384046	PATIN SUPERIOR 308 NYLON	12	C/U
2384047	RIEL SUPERIOR NATURAL X 2 MT.	1	C/U
23840471	RIEL SUPERIOR NATURAL X 3 MT.	1	C/U
23840470	RIEL SUPERIOR ORO X 2 MT.	1	C/U
23840472	RIEL SUPERIOR ORO X 3 MT.	1	C/U
2384049	RIEL INFERIOR NATURAL X 2 MT	1	C/U
23840491	RIEL INFERIOR NATURAL X 3 MT.	1	C/U
23840490	RIEL INFERIOR ORO X 2 MT.	1	C/U
23840492	RIEL INFERIOR ORO X 3 MT.	1	C/U
2384050	PERFIL MANIJON X 2.60 NATURAL	1	C/U
23840500	PERFIL MANIJON X 2.60 ORO	1	C/U
2384052	PERFIL "U" NATURAL X 2 MT.	1	C/U
23840521	PERFIL "U" NATURAL X 3 MT.	1	C/U
23840520	PERFIL "U" ORO X 2 MT.	1	C/U
23840522	PERFIL "U" ORO X 3 MT.	1	C/U
OBS: Puede proveerse también para 15 mm			

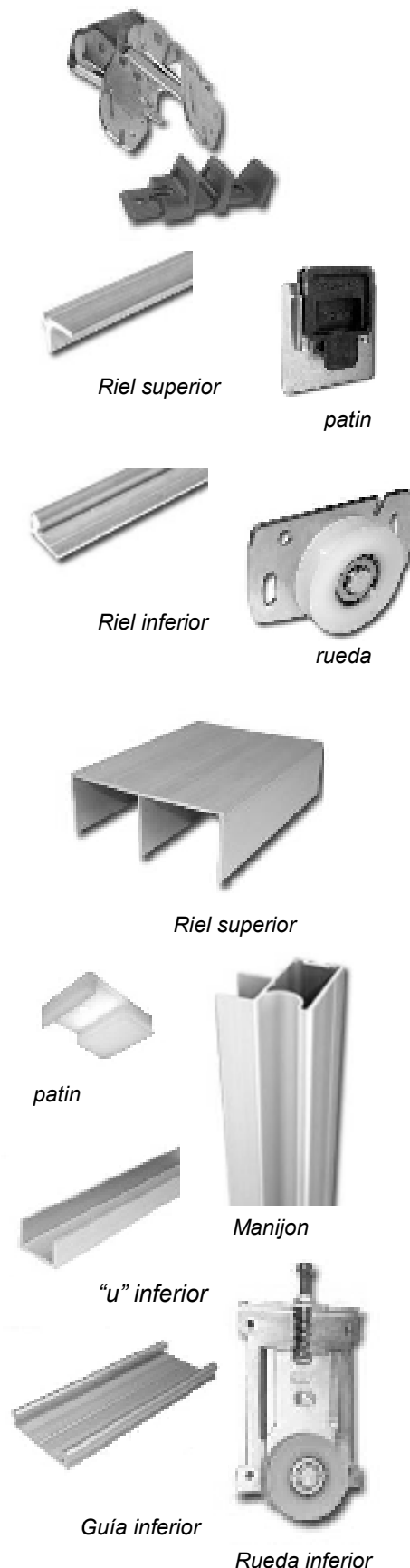

SISTEMA "ELITE"

9125201	SET 2 HOJAS (RUEDAS Y GUIAS)	1	C/U
9125202	SET 3 HOJAS (RUEDAS Y GUIAS)	1	C/U
9125210	RIEL SUPERIOR X 2 MTS.	1	C/U
9125211	RIEL SUPERIOR X 3 MTS.	1	C/U
9125212	RIEL INFERIOR X 2 MTS.	1	C/U
9125213	RIEL INFERIOR X 3 MTS.	1	C/U
9125220	AMORTIGUADOR SUPERIOR	1	C/U
9125221	AMORTIGUADOR INFERIOR	1	C/U

OBS.: Kit :1 set+1 riel superior +1 riel inferior

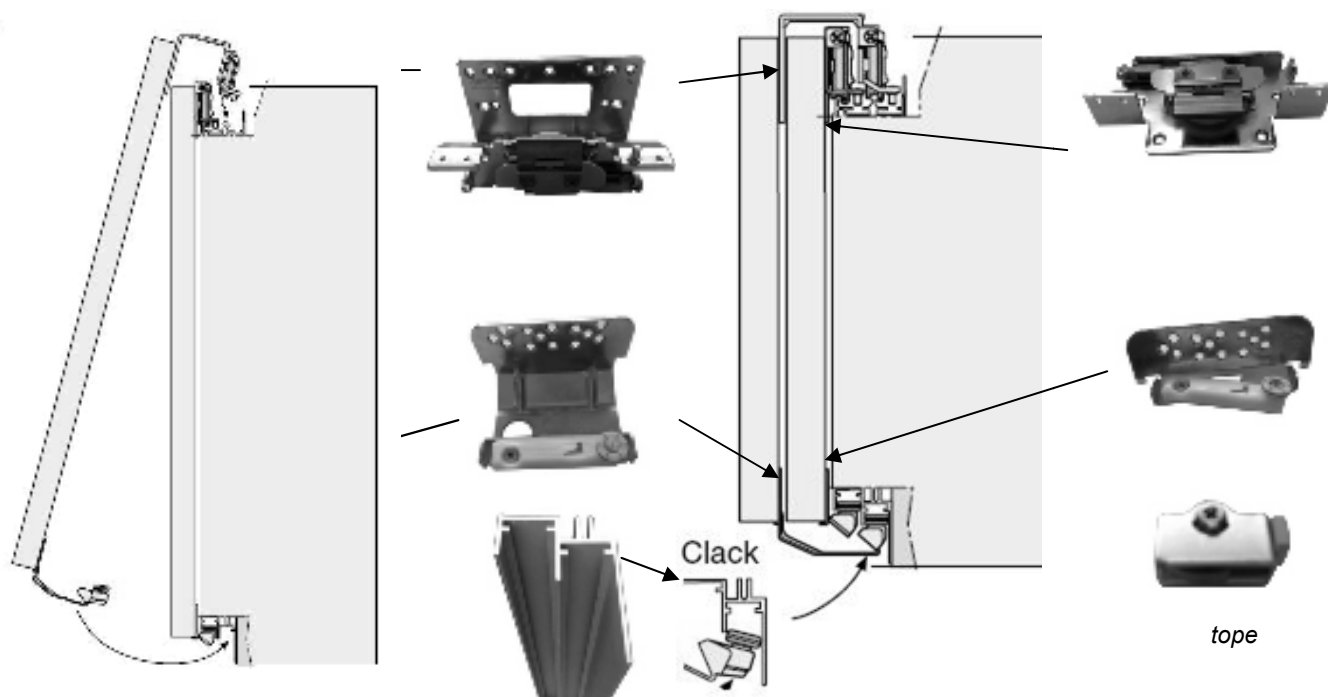
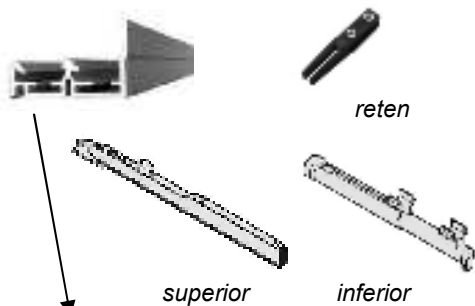

CARRITOS y RIELES PARA VITRINAS

Código	Descripción	X Caja	U.M.
3180105	CARRO SIMPLE P/VITRINA	1	C/U
3180106	CARRO DOBLE P/VITRINA	1	C/U
OBS: Ver perfiles para vitrinas en pag.131			
3530501	RIEL C/RUEDITAS P/VITRINA x 2 mts.	1	C/U
3530502	PERFIL "U" PARA VITRINA x 2 mts.	1	C/U

OBS: En hierro cincado amarillo



APARATO BANDEROLA

Código	Descripción	X Caja	U.M.
2120100	APARATO COMPLETO BRONCEADO	1	JUEGO
2120101	APARATO COMPLETO HIERRO	1	JUEGO
2120102	APARATO COMPLETO BRONCE	1	JUEGO
ACCESORIOS SUELTOS			
2120107	BISAGRA A RESORTE HIERRO	1	C/U
2120110	ROLDANA ENGANCHE HIERRO	1	C/U
2120111	ROLDANA ESQUINERA HIERRO	1	C/U
2120112	ROLDANA INCLINADA HIERRO	1	C/U
2120113	ESCUADRA SUPERIOR HIERRO	1	C/U
2120114	CADENA CON MEDALLÓN HIERRO	1	C/U
CADENAS			
2120401	NUDO N° 17 HIERRO	25	MT.
2120403	NUDO N° 13 HIERRO	25	MT.
2120402	NUDO N° 15 HIERRO	25	MT.
2120404	ESCALERA N° 16 HIERRO	25	MT.
2120420	NUDO N° 17 HIERRO BRONCEADO	25	MT.
2120421	NUDO N° 15 HIERRO BRONCEADO	25	MT.
2120422	NUDO N° 13 HIERRO BRONCEADO	25	MT.
2120423	ESCALERA N° 16 HIERRO BCEADO	25	MT.



Juego completo



escalera

nudo

APARATO SIMPLON

Código	Descripción	X Caja	U.M.
2120103	COMPLETO CON GUIAS Y MANIJA	1	JGO.
2120105	CABEZAL SOLO	1	C/U
2120106	MANIJA PLATIL	1	C/U

OBS: Completo: cabezal, caños guíadores, guía, Cable y manija.



AIREADORES

Código	Descripción	X Caja	U.M.
DER	IZQ		
2500401	25004010	2 ALETAS – 21 CMTS.	1 PAR
2500402	25004020	3 ALETAS – 31 CMTS.	1 PAR
2500403	25004030	4 ALETAS – 41 CMTS.	1 PAR
2500404	25004040	5 ALETAS – 51 CMTS.	1 PAR
2500405	25004050	6 ALETAS – 61 CMTS.	1 PAR
2500406	25004060	7 ALETAS – 71 CMTS.	1 PAR
2500407	25004070	8 ALETAS – 81 CMTS.	1 PAR
2500408	25004080	9 ALETAS – 91 CMTS.	1 PAR
2500410	25004100	10 ALETAS – 101 CMTS.	1 PAR
2500411	25004110	11 ALETAS – 111 CMTS.	1 PAR
2500412	25004120	12 ALETAS – 121 CMTS.	1 PAR
2500413	25004130	13 ALETAS – 131 CMTS.	1 PAR
2500414	25004140	14 ALETAS – 141 CMTS.	1 PAR
2500415	25004150	15 ALETAS – 151 CMTS.	1 PAR



3 aletas

APARATO MOLINILLO

Código	Descripción	X Caja	U.M.
3970105	PARA PARED – BRONCE Nº 1	1	C/U
3970106	PARA PARED – BRONCE Nº 2	1	C/U
3970101	AEREO – ALUMINIO Nº 1	1	C/U
3970102	AEREO – ALUMINIO Nº 2	1	C/U
3970120	MAQUINA CIEGA N.5	1	C/U
3970121	POLIFUNCIONAL CON ESCUADRAS	1	C/U
3970122	POLIFUNCIONAL SIN ESCUADRAS	1	C/U
3970115	MANIJA P/ MOLINILLO	1	C/U
3971001	ESCUADRA BAJO BALCON N.1	1	C/U
3971002	ESCUADRA BAJO BALCON N.2	1	C/U
3971003	GANCHO PUNTA DE FRENTE N.3	1	C/U
3971004	ROSETA PARA BRAZO COMUN N.4	1	C/U
3971005	MAQUINA DE FRENTE N.5/11	1	C/U
3971006	MAQUINA BAJO BALCON N.5/2	1	C/U
3971007	ROSETA P/BZO DIR C/TIRAF N.6	1	C/U
3971008	CORRED.C/RUEDAS ANODIZ. N.7	1	C/U
3971009	TERMINAL DE BRAZO N.8	1	C/U
3971010	ABRAZADERA DE BRAZO N.9	1	C/U
3971011	ROSETA P/BRAZO DIRECTO N.10	1	C/U
3971012	HORQUILLA 1-1/4 DOBLE CAÑO N.12	1	C/U
3971013	TERMINAL DE COLIZA N.13	1	C/U
3971014	CABEZA DE COLIZA N.14	1	C/U
3971015	TOPE REFORZADO N.15	1	C/U
3971016	SOPORTE PARA ATAR SOGA N.16	1	C/U
3971017	PUNTA DE CAÑO REDONDA N.17	1	C/U
3971018	PUNTA DE CAÑO CUADRAD.N.18	1	C/U
3971019	ACOPLE DE TOLDO N.19	1	C/U
3971020	MANIJA PARA TOLDO 1 A 2 MT.	1	C/U
3971021	PUNTA DE CAÑO RED 2" N.23	1	C/U
3971022	PUNTA DE CAÑO CUAD 2" N.24	1	C/U
3971023	DESLIZANTE PARA TOLDO	1	C/U

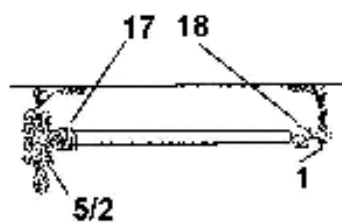
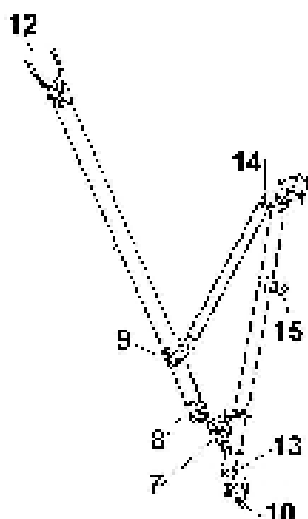
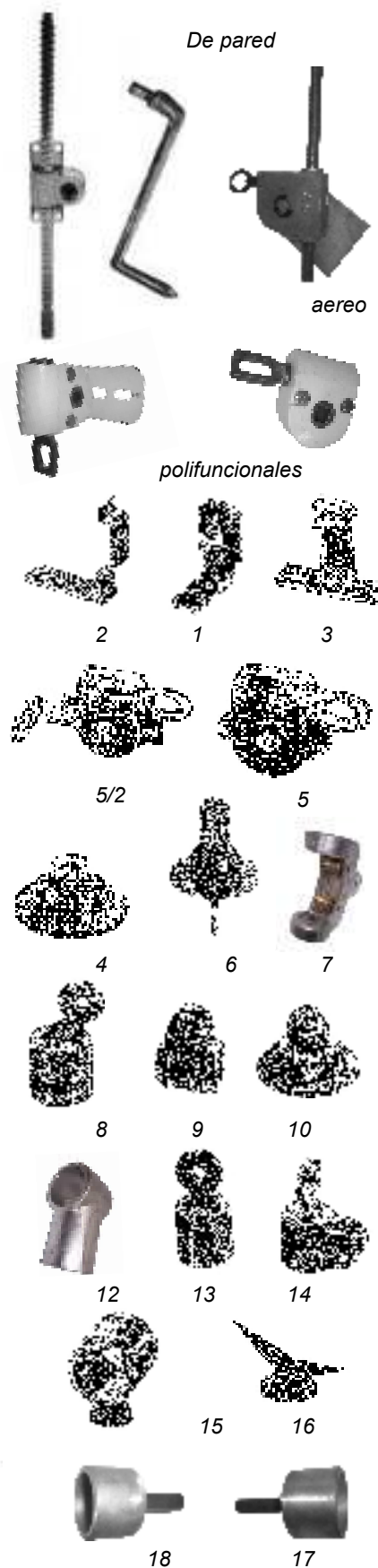

APARATO GUILLOTINA

Código	Descripción	X Caja	U.M.
3201001	LATERAL TIPO A (3.5 A 10 KG.)	1	PAR
3201002	LATERAL TIPO B (10 A 20 KG.)	1	PAR
3201003	LATERAL TIPO C (20.4 A 37 KG.)	1	PAR
3200703	ESQUINERO TIPO A	1	PAR
3200704	ESQUINERO TIPO B	1	PAR

OBS.: SE DEBE CONSIGNAR EL PESO EXACTO DE LA VENTANA.

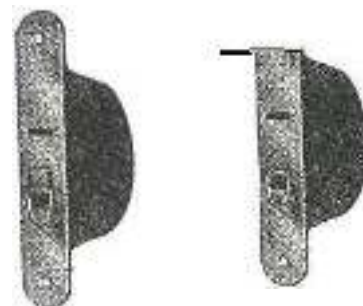

Lateral

Esquinero

MOVIMIENTOS PARA POSTIGONES

Código	Descripción	X Caja	U.M.
DE APLICAR			
8050101	MOVIMIENTO POSTIGON T06-38 CM.	1	PAR
8050102	MOVIMIENTO POSTIGON T07-44 CM.	1	PAR
8050103	MOVIMIENTO POSTIGON T08-50 CM.	1	PAR
8050104	MOVIMIENTO POSTIGON T09-56 CM.	1	PAR
8050105	MOVIMIENTO POSTIGON T10-62 CM.	1	PAR
8050106	MOVIMIENTO POSTIGON T11-68 CM.	1	PAR
8050107	MOVIMIENTO POSTIGON T12-74 CM.	1	PAR
8050108	MOVIMIENTO POSTIGON T13-80 CM.	1	PAR
8050109	MOVIMIENTO POSTIGON T14-86 CM.	1	PAR
8050110	MOVIMIENTO POSTIGON T15-92 CM.	1	PAR
8050111	MOVIMIENTO POSTIGON T16-98 CM.	1	PAR
8050112	MOVIMIENTO POSTIGON T17-104 CM	1	PAR
8050113	MOVIMIENTO POSTIGON T18-110 CM	1	PAR
8050114	MOVIMIENTO POSTIGON T19-116 CM	1	PAR
8050115	MOVIMIENTO POSTIGON T20-122 CM	1	PAR
8050116	MOVIMIENTO POSTIGON T21-128 CM	1	PAR
8050117	MOVIMIENTO POSTIGON T22-134 CM	1	PAR
8050118	MOVIMIENTO POSTIGON T23-140 CM	1	PAR
8050119	MOVIMIENTO POSTIGON T24-146 CM	1	PAR
8050120	MOVIMIENTO POSTIGON T25-152 CM	1	PAR

DE EMBUTIR

8050201	MOVIMIENTO POSTIGON AT06-38 CM.	1	PAR
8050202	MOVIMIENTO POSTIGON AT07-44 CM.	1	PAR
8050203	MOVIMIENTO POSTIGON AT08-50 CM.	1	PAR
8050204	MOVIMIENTO POSTIGON AT09-56 CM.	1	PAR
8050205	MOVIMIENTO POSTIGON AT10-62 CM.	1	PAR
8050206	MOVIMIENTO POSTIGON AT11-68 CM.	1	PAR
8050207	MOVIMIENTO POSTIGON AT12-74 CM.	1	PAR
8050208	MOVIMIENTO POSTIGON AT13-80 CM.	1	PAR
8050209	MOVIMIENTO POSTIGON AT14-86 CM.	1	PAR
8050210	MOVIMIENTO POSTIGON AT15-92 CM.	1	PAR
8050211	MOVIMIENTO POSTIGON AT16-98 CM.	1	PAR
8050212	MOVIMIENTO POSTIGON AT17-104 CM	1	PAR
8050213	MOVIMIENTO POSTIGON AT18-110 CM	1	PAR
8050214	MOVIMIENTO POSTIGON AT19-116 CM	1	PAR

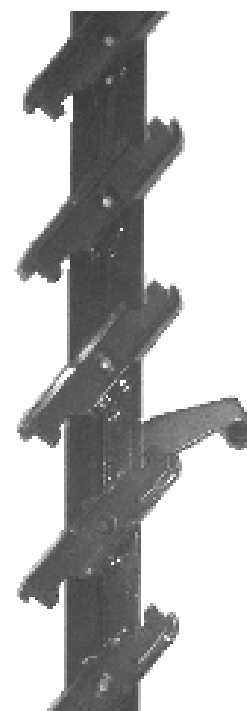

El primer numero del código se refiere a la cantidad de tablillas. Por ej. el AT06 es para 6 tablillas.

8050215	MOVIMIENTO POSTIGON AT20-122 CM	1	PAR
8050216	MOVIMIENTO POSTIGON AT21-128 CM	1	PAR
8050217	MOVIMIENTO POSTIGON AT22-134 CM	1	PAR
8050218	MOVIMIENTO POSTIGON AT23-140 CM	1	PAR
8050219	MOVIMIENTO POSTIGON AT24-146 CM	1	PAR
8050220	MOVIMIENTO POSTIGON AT25-152 CM	1	PAR
8050221	SUPLEMENTO PARA APLICAR EN ALU	1	PAR

OBS: Color marron.A pedido en color blanco.

POLEAS DE REDUCCION

Código	Descripción	X Caja	U.M.
2130103	1 X 3 HIERRO	1	C/U
2130107	1 X 3 NYLON	1	C/U
2130102	1 X 4 HIERRO	1	C/U
2130106	1 X 4 NYLON	1	C/U
2130101	1 X 5 HIERRO	1	C/U
2130110	1 X 4 HIERRO DOBLE COMANDO	1	C/U
2130111	1 X 4 HIERRO CON ESTABILIZADOR	1	C/U
2130125	1 X 3 SIN FIN	1	C/U
2130130	JUEGO PASACINTA SIN FIN Y CINTA	1	C/U
2130120	GRAMPA SOLA P/REDUCTOR	1	C/U



Tabla indicativa en pag 170

POLEAS DE CHAPA

Código	Descripción	X Caja	U.M.
2600201	20 CM CINCADA	10	C/U
2600202	23 CM CINCADA	10	C/U
2600203	26 CM PINTADA	10	C/U

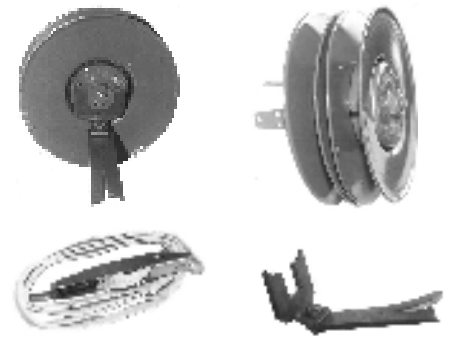

EJES PARA CORTINA Y ACCESORIOS

Código	Descripción	X Caja	U.M.
2600252	EJE OCTOGONAL CINC.X 1.62 MTS	1	C/U
2600253	EJE OCTOGONAL CINC.X 1.92 MTS	1	C/U
2600254	EJE OCTOGONAL CINC.X 2.12 MTS	1	C/U
2600255	EJE OCTOGONAL CINC.X 2.52 MTS	1	C/U
2600256	EJE OCTOGONAL CINC.X 6.30 MTS	1	C/U
2620111	TACO OCTOGONAL MADERA 70 M/M	1	C/U
2620118	CORAZON PLASTICO OCTOGONAL	1	C/U
2620116	CORAZON DE MADERA CUADRADO	1	C/U
2150203	PUNTA DE EJE REFORZADA	1	C/U
2150201	GRAMPA GIRATORIA (PARA PUNTA)	1	C/U
2150202	GRAMPA PARA RULEMAN	1	C/U
2170250	RULEMAN PARA CORTINA	1	C/U
2600235	CARDAN DE ACOPLA	1	C/U

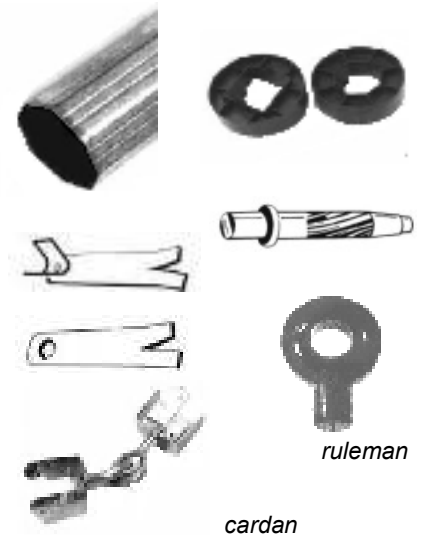

ruleman

cardan

CINTA PARA CORTINA

Código	Descripción	X Caja	U.M.
2145050	N'7 VERDE ECONOMICA	100	MT
2145051	N'8 BLANCA RAYADA	100	MT
2145052	N'10 BLANCA	100	MT
2145054	N'18 MINI	100	MT



TOPES PARA CORTINA

Código	Descripción	X Caja	U.M.
2199010	C/GOMA CINCADO	1	C/U
2600302	PLASTICO BLANCO	1	C/U



PASACINTAS

Código	Descripción	X Caja	U.M.
2150207	DOBLE DE AMURAR	1	C/U
2021020	DOBLE FRONTAL	1	C/U



ENRROLLADORES

Código	Descripción	X Caja	U.M.
2600220	4 Mts ZINC FRENO SIMPLE	50	C/U
2600221	6 Mts ZINC FRENO SIMPLE	50	C/U
2600222	8 Mts ZINC FRENO SIMPLE	50	C/U
2122004	10 Mts ZINC FRENO SIMPLE	1	C/U
2122005	12 Mts ZINC FRENO SIMPLE	1	C/U
2122006	15 Mts ZINC FRENO SIMPLE	1	C/U
2600229	PICCOLINO (CINTA 18 MM)	1	C/U
2600314	4 MTS CINC.AMAR.CON BUCHE	1	C/U
2600315	6 MTS CINC.AMAR.CON BUCHE	1	C/U
2600316	8 MTS CINC.AMAR.CON BUCHE	1	C/U
2080801	4 MTS.DOBLE BRAZO CINCADO	30	C/U
2080802	6 MTS.DOBLE BRAZO CINCADO	30	C/U



ENROLLADORES LATERALES

2600225	4 MTS DER	26002250	IZQ	1	C/U
2600226	6 MTS DER	26002260	IZQ	1	C/U
2600227	8 MTS DER	26002270	IZQ	1	C/U

CAJAS P/ENRROLLADORES

Código	Descripción	X Caja	U.M.
2620101	PARA 4 MTS.	1	C/U
2620102	PARA 6 MTS.	1	C/U
2620103	PARA 8 MTS.	1	C/U



APARATO MARAVILLA

Código	Descripción	X Caja	U.M.
2600101	T1 COMPLETO	1	C/U
2600102	CUERPO SOLO T1	1	C/U
2600105	CAJA DE AMURAR T1	1	C/U
2600107	TAPA METALICA EPOXI T1	1	C/U
2600110	POLEA DE CHAPA T1	1	C/U
2600103	CABLE DE ACERO T1	1	C/U
2600150	APARATO T2 COMPLETO	1	C/U
2600151	CUERPO SOLO T2	1	C/U
2600152	CAJA DE AMURAR T2	1	C/U
2600154	TAPA METALICA EPOXI T2	1	C/U
2600157	POLEA DE CHAPA T2	1	C/U
2600158	CABLE DE ACERO T2	1	C/U
2600106	MOV.UNIVERSAL NYLON (T1-T2)	1	C/U
2600108	MANIVELA (T1-T2)	1	C/U
2600109	TERMINAL DE NYLON (T1-T2)	1	C/U



Completo: Caja, cuerpo, cable, mov. de nylon, tapa, rulemanes, puntas, grapas manivela, topes, polea

APARATO "SUAVELEV"

Código	Descripción	X Caja	U.M.
2790116	A 2 COMPLETO	1	C/U
2790117	A 3 COMPLETO	1	C/U

OBS: **Se compone de:**
 Caja de amurar
 Maquina con manivela y fleje
 Caño - Polea
 Rodillo de salida

Capacidades

A2 - 4 M2
 A3 - 9 M2

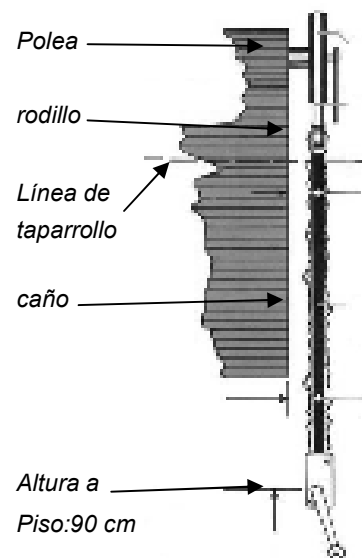

HERRAJES PARA CORTINA BARRIO

Código	Descripción	X Caja	U.M.
2600310	FLEJE PARA CORTINA BARRIO	25	MT.
2600325	RODILLO DE EMPUJE 40 MM	1	C/U
2600326	RODILLO DE EMPUJE 60 MM	1	C/U
2620118	CORAZON PLASTICO EJE OCTOG.	1	C/U
2620115	CORAZON DE MADERA EJE CUADR	1	C/U
2600373	BISAGRA PARA CORTINA BARRIO	1	C/U
2600374	ARO COSTANERO	1	C/U
2600375	HEBILLA	1	C/U
2600376	ESLABON COSTANERO	1	C/U
2600377	CHICOTE	1	C/U
2600378	LENGÜETA SOLA	1	C/U



ALAMBRES PARA UNION DE TABLILLAS

Código	Descripción	X Caja	U.M.
2600401	GANCHO ZOCALO	1	CIEN
2600402	GANCHO TERMINAL	1	CIEN
2600403	GANCHO INTERMEDIO 14X52	1	CIEN



Tabla de orientación para determinar el tipo de reductor y largo de cinta a emplear, según la medida de la cortina en tipo rauli.

		ANCHO EN METROS														
		1		1,50		1,80		2,20		2,60		3		3,50		
ALTO EN METROS	1	P 20	P 20	P 20	P 20	P 23	R 1x3	R 1x3	R 1x3	R 1x3	R 1x3	R 1x3	R 1x3	R 1x3	R 1x3	
	C 1,20mt	C 1,20mt	C 1,20mt	C 1,20mt	C 1,70mt	C 3,30mt	C 3,30mt	C 3,30mt	C 3,30mt	C 3,30mt	C 3,30mt	C 3,30mt	C 3,30mt	C 3,30mt	C 3,30mt	
	1,5	P 20	P 23	R 1x3	R 1x3	R 1x3	R 1x3	R 1x3	R 1x3	R 1x3	R 1x3	R 1x3	R 1x3	R 1x3	R 1x3	R 1x3
	C 1,50mt	C 2,10mt	C 4,70mt	C 4,70mt	C 4,70mt	C 4,70mt	C 4,70mt	C 4,70mt	C 4,70mt	C 4,70mt	C 4,70mt	C 4,70mt	C 4,70mt	C 4,70mt	C 4,70mt	C 4,70mt
	1,80	P 20	R 1x3	R 1x3	R 1x3	R 1x3	R 1x3	R 1x3	R 1x3	R 1x3	R 1x3	R 1x3	R 1x3	R 1x3	R 1x3	R 1x4
	C 1,80mt	C 5,30mt	C 5,30mt	C 5,30mt	C 5,30mt	C 5,30mt	C 5,30mt	C 5,30mt	C 5,30mt	C 5,30mt	C 5,30mt	C 5,30mt	C 5,30mt	C 5,30mt	C 5,30mt	C 5,30mt
	2,20	P 23	R 1x3	R 1x3	R 1x3	R 1x3	R 1x3	R 1x3	R 1x3	R 1x3	R 1x3	R 1x3	R 1x3	R 1x3	R 1x3	R 1x4
C 2,00mt	C 6,20mt	C 6,20mt	C 6,20mt	C 6,20mt	C 6,20mt	C 6,20mt	C 6,20mt	C 6,20mt	C 6,20mt	C 6,20mt	C 6,20mt	C 6,20mt	C 6,20mt	C 6,20mt	C 9,90mt	
2,60	R 1x3	R 1x3	R 1x3	R 1x3	R 1x3	R 1x3	R 1x3	R 1x3	R 1x3	R 1x3	R 1x3	R 1x3	R 1x3	R 1x3	R 1x4	
C 6,80mt	C 6,80mt	C 6,80mt	C 6,80mt	C 6,80mt	C 6,80mt	C 6,80mt	C 6,80mt	C 6,80mt	C 6,80mt	C 6,80mt	C 6,80mt	C 6,80mt	C 6,80mt	C 6,80mt	C 11,40mt	
3	R 1x3	R 1x3	R 1x3	R 1x3	R 1x3	R 1x3	R 1x3	R 1x3	R 1x3	R 1x3	R 1x3	R 1x3	R 1x3	R 1x3	R 1x4	
C 7,45mt	C 7,45mt	C 7,45mt	C 7,45mt	C 7,45mt	C 7,45mt	C 7,45mt	C 7,45mt	C 7,45mt	C 7,45mt	C 7,45mt	C 7,45mt	C 7,45mt	C 7,45mt	C 7,45mt	C 12,90mt	
ABREVIATURAS: "P": POLEA – "C": CINTA – "R": REDUCTOR – "mt": METROS																

CIERRAPUERTAS AEROS HIDRAULICOS

YANK

Código	Descripción	X Caja	U.M.
YANK			
9070101	YANK 800 PARA 25 A 35 KGM	10	C/U
9070102	YANK 900 PARA 40 A 65 KGM	10	C/U
9070103	YANK 805 PARA 60 A 85 KGM	10	C/U
NEW STAR			
9042007	NEW STAR N.85	6	C/U
9042008	NEW STAR N.86	6	C/U

OBS.: Los cierrapuertas aéreos vienen en color gris.



CIERRAPUERTAS AEREO A RESORTE

Código	Descripción	X Caja	U.M.
1150101	N: 1 DER o IZQ	1	C/U
1150102	N: 2 DER o IZQ	1	C/U
1150103	N: 3 DER o IZQ	1	C/U
1150104	N: 4 DER o IZQ	1	C/U
1150105	N: 5 DER o IZQ	1	C/U



CIERRAPUERTAS PARA EMPOTRAR AL PISO

Código	Descripción	X Caja	U.M.
TRIAL			
1150205	3 A DOBLE ACCION P/MAD-METAL	1	C/U
1150301	3 A DOBLE ACCION P/CRISTAL	1	C/U
1150206	3 B DOBLE ACCION P/MAD-METAL	1	C/U
1150302	3 B DOBLE ACCION P/CRISTAL	1	C/U
1150207	3 C DOBLE ACCION P/MAD-CRISTAL	1	C/U
1150304	3 C DOBLE ACCION P/CRISTAL	1	C/U
1150501	MAQUINA SOLA 3 A	1	C/U
1150502	MAQUINA SOLA 3 B	1	C/U
1150503	MAQUINA SOLA 3 C	1	C/U
OBS: MAD-MET: INCLUYE LOS PIVOT INFERIOR Y SUPERIOR			
CRISTAL: SIN HERRAJES			

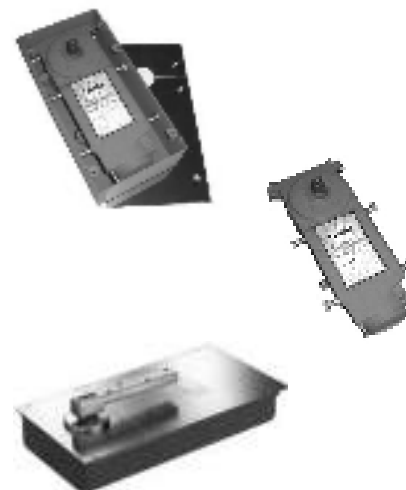
**YANK**

9070120	MOD 1330 HASTA 70 KG	6	C/U
9070121	MOD 1340 HASTA 130 KG	6	C/U



CIERRAPUERTA A RESORTE PARA ZOCALO

1281520	CON TAPA CINCADA	1	C/U
1281521	CON TAPA BRONCE	1	C/U

OBS: Para puerta vaivén, sin freno hidráulico

CIERRAPUERTAS PARA PUERTAS CORREDIZAS

Código	Descripción	X Caja	U.M.
9070190	DE APLICAR CON TANZA	1	C/U
9070131	SISTEMA P/ EMBUTIR POR DESNIVEL	1	C/U
9070130	SISTEMA P/DOBLE HOJA EN TANDEM	1	C/U

OBS: **Vea video explicativo en nuestra pagina**

REPUESTOS P/CIERRAPUERTAS

Código	Descripción	X Caja	U.M.
1151010	CASQUILLO P/CIERRAP.DE PISO	1	C/U
1150820	PALANCA DOBLE ACCION 3 A-B-C	1	JGO.
1150821	PALANCA DOBLE ACCION 3 D	1	JGO.
1150824	PALANCA SIMPLE ACCION 3 A-B-C	1	JGO.
1150825	PALANCA SIMPLE ACCION 3 D	1	JGO.
1150802	TAPA BRONCE (RECARGO)	1	JGO.



Doble acción

Palancas simple acción

CUERDAS PARA CIERRA PUERTAS

Código	Descripción	X Caja	U.M.
1190101	P/TRIAL N. 2	1	C/U
1190102	P/TRIAL N. 3	1	C/U
1190103	P/TRIAL N. 4	1	C/U
1190104	P/TRIAL N. 5	1	C/U
1190105	P/TABOS N.1	1	C/U
1190106	P/TABOS N. 2	1	C/U
1190107	P/TABOS N. 3	1	C/U
1190108	P/TABOS N. 4	1	C/U
1190109	P/TABOS N.5	1	C/U
1190110	P/COCECO N. 1	1	C/U
1190111	P/COCECO N. 2	1	C/U
1190112	P/COCECO N. 3	1	C/U
1190113	P/COCECO N.4	1	C/U
1190114	P/COCECO N.5	1	C/U
1190115	P/H.M. N. 2	1	C/U
1190116	P/H.M. N. 3	1	C/U
1190117	P/H.M. N. 4	1	C/U
1190126	P/H.M. N.F 33	1	C/U
1190127	P/H.M. N.F 34	1	C/U



CIERRAPUERTA MOSQUITERO

Código	Descripción	X Caja	U.M.
1190201	REF FUNDIDO NEGRO	6	C/U
1190202	REF FUNDIDO GRIS	6	C/U
3202001	CIERRAPUERTA MOSQUITERO NEGR	12	C/U
3202002	CIERRAPUERTA MOSQUITERO CINC.	12	C/U



REPUESTO P/CIERRAPUERTA MOSQUITERO

Código	Descripción	X Caja	U.M.
1190203	RESORTE P/TRIUNFO (FUNDIDO)	1	C/U



TABLA DE MEDIDAS Y PESOS DE CIERRAPUERTAS

MARCA	MODELO	MEDIDA (EN CM.)	PESO
YANK	800	80X180	30
YANK	800	90X210	45
YANK	900	105X210	65
YANK	900	105X240	85
YANK	1330	HASTA 80 CM	70
YANK	1340	HASTA 100 CM	130
NEW STAR	85	120X240	120
NEW STAR	86	180X270	180
TRIAL	1	HASTA 70	
TRIAL	2	HASTA 80	
TRIAL	3	HASTA 90	
TRIAL	4	HASTA 100	
TRIAL	5	HASTA 115	
TRIAL	3-A	ANCHO 60-70	50
TRIAL	3-B	ANCHO 85-100	170
TRIAL	3-C	ANCHO 110-130	200

ATENCIÓN

PARA DETERMINAR EL MODELO A USAR BASTA CON QUE SE CUMPLA UNO DE LOS DOS FACTORES DETERMINANTES. ASI, POR EJ. UNA PUERTA QUE PESE 45 KG. LLEVARA UN CIERRAPUERTA 800, AUNQUE NO LLEGUE A LA MEDIDA INDICADA. SI LA PUERTA ESTA SOMETIDA A FUERTES CORRENTADAS CONVENDRA COLOCAR UNA MEDIDA SUPERIOR A LA DETERMINADA.

SOPORTES CENTRALES DE HIERRO



Código	Descripción	X Caja	U.M.
ABIERTO	CERRADO		
3860601	3860605 BRONCEADO ½ X 20	50	C/U
38606010	38606050 NIQUELADO ½ X 20	50	C/U
3860602	3860606 BRONCEADO ½ X 35	50	C/U
38606020	38606060 NIQUELADO ½ X 35	50	C/U
3860603	3860607 BRONCEADO ½ X 60	50	C/U
38606030	38606070 NIQUELADO ½ X 60	50	C/U
3860610	3860614 BRONCEADO 5/8 X 20	50	C/U
38606100	38606140 NIQUELADO 5/8 X 20	50	C/U
3860611	3860615 BRONCEADO 5/8 X 35	50	C/U
38606110	38606150 NIQUELADO 5/8 X 35	50	C/U
3860612	3860616 BRONCEADO 5/8 X 60	50	C/U
38606120	38606160 NIQUELADO 5/8 X 60	50	C/U
3860620	3860623 BRONCEADO ¾ X 20	50	C/U
38606200	38606230 NIQUELADO ¾ X 20	50	C/U
3860621	3860624 BRONCEADO ¾ X 35	50	C/U
38606210	38606240 NIQUELADO ¾ X 35	50	C/U
3860622	3860625 BRONCEADO ¾ X 60	50	C/U
38606220	38606250 NIQUELADO ¾ X 60	50	C/U

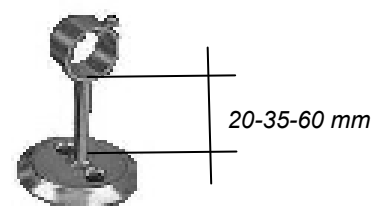

SOPORTES CENTRALES DE BRONCE

Código	Descripción	X Caja	U.M.
ABIERTOS			
2493403	PULIDO ½ X 39	1	C/U
2493433	PLATIL ½ X 39	1	C/U
CERRADOS			
2493503	PULIDO ½ X 39	1	C/U
2493533	PLATIL ½ X 39	1	C/U
2493505	PULIDO 5/8 X 37	1	C/U
2493535	PLATIL 5/8 X37	1	C/U
2493507	PULIDO ¾ X 37	1	C/U
2493537	PLATIL ¾ X37	1	C/U
2493508	PULIDO 1" X 32	1	C/U
2493538	PLATIL 1" X 32	1	C/U



CERRADOS PASANTES Y CON TAPA

PULIDO	PLATIL		X Caja	U.M.
3830005	38300050 PASANTE 1"		1	C/U
3830006	38300060 PASANTE 1 ¼"		1	C/U
3830007	38300070 PASANTE 1 ½"		1	C/U
3830008	38300080 PASANTE 2"		1	C/U
3830014	38300140 TAPADO 1"		1	C/U
3830015	38300150 TAPADO 1 ¼"		1	C/U
3830016	38300160 TAPADO 1 ½"		1	C/U
3830017	38300170 TAPADO 2"		1	C/U



SOPORTES LATERALES CON ROSCA



Código	Descripción	X Caja	U.M.
TUBULARES CON AGUJERO CENTRAL			
PULIDO	PLATIL		
3860325	38603250 1/2"	24	C/U
3860326	38603260 5/8"	24	C/U
3860327	38603270 3/4"	24	C/U
3860328	38603280 1"	24	C/U
TUBULARES CON BASE DOS AGUJEROS			
3860310	1/2 PLANO BRONCEADO	24	C/U
3860311	5/8 PLANO BRONCEADO	24	C/U
3860314	3/4 PLANO BRONCEADO	24	C/U
3860316	1/2 ACODADO BRONCEADO	24	C/U
3860318	5/8 ACODADO BRONCEADO	24	C/U
3860320	3/4 ACODADO BRONCEADO	24	C/U

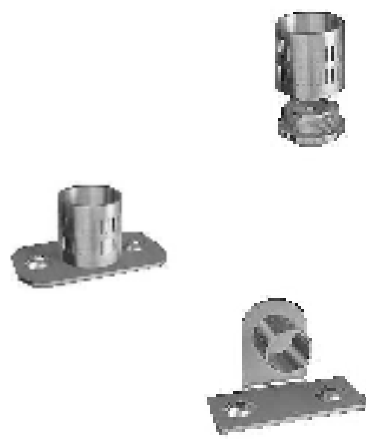

SOPORTES LATERALES FIJOS DE BRONCE

Código	Descripción	X Caja	U.M.
PULIDO	PLATIL		
2434003	24340030 3/4	50	C/U
2434004	24340040 1"	50	C/U
3830071	38300710 1 1/4"	12	C/U
3830072	38300720 1 1/2"	12	C/U
3830073	38300730 2"	12	C/U



MENSULAS PARA CAÑO



Código	Descripción	X Caja	U.M.
ABIERTA	CERRADA	10	C/U
3860402	3860403 SIMPLE 1/2 BRONCEADA	10	C/U
3860404	3860405 SIMPLE 5/8 BRONCEADA	10	C/U
3860406	3860407 SIMPLE 3/4 BRONCEADA	10	C/U
3860408	3860409 DOBLE 1/2 BRONCEADA	10	C/U
3860410	3860411 DOBLE 5/8 BRONCEADA	10	C/U
3860412	3860413 DOBLE 3/4 BRONCEADA	10	C/U

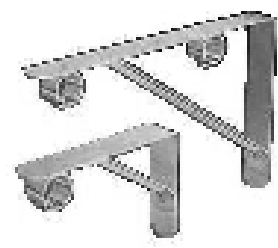

TERMINALES PLASTICOS P/ CAÑO

Código	Descripción	X Caja	U.M.
3860501	1/2 DORADO	100	C/U
3860502	1/2 CROMADO	100	C/U
3860503	5/8 DORADO	100	C/U
3860505	5/8 CROMADO	100	C/U



TAPAS DE BRONCE PARA CAÑOS

Código	Descripción	X Caja	U.M.
PULIDO	PLATIL		
3830052	38300520 TAPA CAÑO 1"	1	C/U
3830053	38300530 TAPA CAÑO 1 1/4"		
3830054	38300540 TAPA CAÑO 1 1/2"	1	C/U
3830055	38300550 TAPA CAÑO 2"	1	C/U



CAÑOS DE HIERRO PARA CORTINAS

Código	Descripción	X Caja	U.M.
3070101	CANO H'CINCADO 1/2' AZUL	30	MT.
30701010	CANO H'CINCADO 1/2' AMARILLO	30	MT.
3070102	CAÑO H'CINCADO 5/8" AZUL	30	MT.
30701020	CAÑO H'CINCADO 5/8" AMARILLO	30	MT.
3070103	CANO H'CINCADO 3/4' AZUL	30	MT.
30701030	CANO H'CINCADO 3/4' AMARILLO	30	MT.
3070104	CANO H'CINCADO 1' AZUL	30	MT.
30701040	CANO H'CINCADO 1' AMARILLO	30	MT.

OBS: Tiras de 3 mts.Excepto 1/2, también en 4 mts



BARRALES DE MADERA Y ACCESORIOS

Código	Descripción	X Caja	U.M.		
BARRALES					
22 MM	34 MM	14 MM			
4990801	4990811	4990790	CEDRO X 1.40	1	C/U
4990802	4990812	4990791	CEDRO X 1.80	1	C/U
4990803	4990813	4990792	CEDRO X 2.00	1	C/U
4990804	4990814	4990793	CEDRO X 2.40	1	C/U
SOPORTES COLONIALES					
22 MM	34 MM	14 MM			
4991011	4991012	4991010	ABIERTO	1	C/U
4991014	4991015	4991013	CERRADO	1	C/U
TERMINALES					
4991030	CEDRO 14 MM			1	C/U
4991031	CEDRO 22 MM			1	C/U
4991032	CEDRO 34 MM			1	C/U
ARGOLLAS					
4991020	ARGOLLA CON PITON 14 MM			1	C/U
4991021	ARGOLLA CON PITON 22 MM.			1	C/U
4991022	ARGOLLA CON PITON 34 MM.			1	C/U

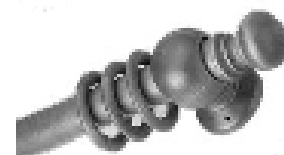

RIELES PARA CORTINA

Código	Descripción	X Caja	U.M.
3860802	RIEL AMERICANO (MT)	1	MT.
OBS: Los paños corren accionando la cuerda			
3860804	RIEL EUROPEO (MT)	1	MT.
OBS.: Se corre manualmente con la varilla			
LARGOS: DE 0.20 MTS. EN 0.20 MTS. De 1 a 4 mts.			

SABELCORT



VARILLAS Y SOPORTES PARA VISILLOS

Código	Descripción	X Caja	U.M.
3860110	VARILLA PLASTIFICADA BLANCA	25	MT.
3860202	SOPORTE CON TORNILLO BCEADO	100	C/U
3860203	SOPORTE CON TORNILLO NIQUEL	100	C/U
3860214	SOPORTE A PRESION BRONCEADO	100	C/U
3860215	SOPORTE A PRESION NIQUELADO	100	C/U

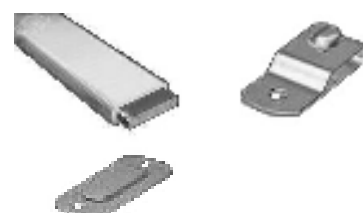

EXTENSIBLES P/BAÑO

SABELCORT

Código	Descripción	X Caja	U.M.
3860702	COMUN ALUMINIO NATURAL	1	C/U
3860704	COMUN BLANCO	1	C/U
3860706	"DE LUJO" BLANCO	1	C/U
3860708	"DE LUJO" RAYADO DORADO	1	C/U
38607080	"DE LUJO" RAYADO CROMADO	1	C/U

OBS.: EXTENSIBLE DE 1.00 A 2.00 MTS

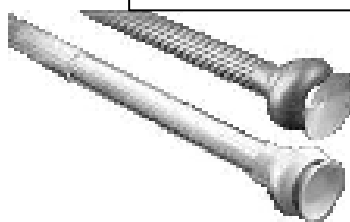

BARRALES PARA BAÑO

Código	Descripción	X Caja	U.M.
3860350	CURVO BLANCO 90 X 90	1	C/U
3860351	CURVO BLANCO 100 X 100	1	C/U
3860352	CURVO BLANCO 75 X 175	1	C/U
3860355	RECTO BLANCO 1.40 MTS	1	C/U
3860356	RECTO BLANCO 1.60 MTS	1	C/U
3860357	RECTO BLANCO 1.80 MTS	1	C/U
3860358	RECTO BLANCO 2.00 MTS	1	C/U
3860341	SOPORTE PARA CAÑO BLANCO	1	PAR
3860340	SOPORTE PARA CAÑO NATURAL	1	PAR



PUNTAS DE ALUMINIO PARA REJAS

Código	Descripción	X Caja	U.M.
2520102	FLOR DE LIZ 125 MM.-1/2"	1	C/U
2520103	FLOR DE LIZ 125 MM.-9/16"	1	C/U
2520104	FLOR DE LIZ 145 MM.-1/2"	1	C/U
2520105	FLOR DE LIZ 145 MM.-9/16"	1	C/U
2520106	FLOR DE LIZ 145 MM.-5/8"	1	C/U
2520107	FLOR DE LIZ PLANA 1/2	1	C/U
2520108	FLOR DE LIZ PLANA 9/16	1	C/U
2520110	FLECHA CHICA 1/2	1	C/U
2520111	FLECHA CHICA 9/16	1	C/U
2520112	FLECHA GRANDE 9/16	1	C/U
2520113	FLECHA GRANDE 5/8	1	C/U
2520114	VIKINGO CHICA 1/2"	1	C/U
2520115	VIKINGO CHICA 9/16	1	C/U
2520116	VIKINGO MEDIANA 9/16	1	C/U
2520117	VIKINGO MEDIANA 5/8	1	C/U
2520118	VIKINGO GRANDE 9/16	1	C/U
2520119	VIKINGO GRANDE 5/8	1	C/U
2520120	VIKINGO GRANDE 3/4	1	C/U
2520121	TRIANGULAR CHICA 1/2	1	C/U
2520122	TRIANGULAR CHICA 9/16	1	C/U
2520123	TRIANGULAR GRANDE 9/16	1	C/U
2520124	TRIANGULAR GRANDE 5/8	1	C/U
2520125	TRIANGULAR GRANDE 3/4	1	C/U
2520126	LANZA CHICA 1/2	1	C/U
2520127	LANZA CHICA 9/16	1	C/U
2520128	LANZA CHICA 5/8	1	C/U
2520129	LANZA GRANDE 5/8	1	C/U
2520130	LANZA GRANDE 3/4	1	C/U
2520131	IGLESIA 1/2	1	C/U
2520132	IGLESIA 9/16	1	C/U
2520135	INGLESA GRANDE 9/16	1	C/U
2520136	INGLESA GRANDE 5/8	1	C/U
2520137	INGLESA GRANDE 3/4	1	C/U



Liz comun

Liz plana



Flecha chica



Chica/med.

Grande



triangular



Lanza chica

Lanza grande



iglesia



inglesa

2520141	GOTA ½	1	C/U
2520142	GOTA 9/16	1	C/U
2520143	GERMANA 1/2	1	C/U
2520144	GERMANA 9/16	1	C/U
2520146	ZULÚ CHICA ½	1	C/U
2520147	ZULÚ CHICA 9/16	1	C/U
2520148	ZULÚ GRANDE 9/16	1	C/U
2520149	ZULÚ GRANDE 5/8	1	C/U
2520151	PINO ½	1	C/U
2520152	PINO 9/16	1	C/U
2520153	PINO 15X15 (PARA CAÑO)	1	C/U
2520154	PINO 20X20 (PARA CAÑO)	1	C/U

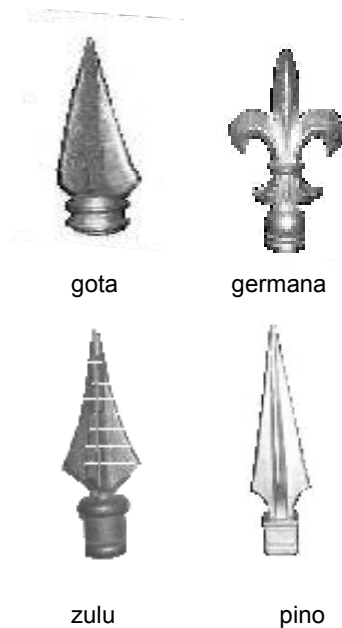

PERRERAS Y BOCHAS

2520138	PERRERA ½	1	C/U
2520139	PERRERA 9/16	1	C/U
2520140	PERRERA 5/8	1	C/U
2520170	ESFERA LISA CHICA 3/8		
2520171	ESFERA LISA CHICA ½	1	C/U
2520172	ESFERA LISA CHICA 9/16	1	C/U
2520173	ESFERA LISA GRANDE ½	1	C/U
2520174	ESFERA LISA GRANDE 9/16	1	C/U
2520175	ESFERA LISA GRANDE 5/8	1	C/U
2520176	ESFERA TROMPO CHICO ½	1	C/U
2520177	ESFERA TROMPO CHICO 9/16	1	C/U
2520178	ESFERA TROMPO GRANDE ½	1	C/U
2520179	ESFERA TROMPO GRANDE 9/16	1	C/U
2520180	ESFERA TROMPO GRANDE 5/8	1	C/U
2520181	ESFERA CON PUNTA ½	1	C/U
2520182	ESFERA CON PUNTA 9/16	1	C/U
2520183	ESFERA CON PUNTA 5/8	1	C/U
2520185	ESF.C/SOMBRERO CHICA ½	1	C/U
2520186	ESF.C/SOMBRERO CHICA 9/16	1	C/U
2520187	ESF.C/SOMBRERO GRANDE ½	1	C/U
2520188	ESF.C/SOMBRERO GRANDE 9/16	1	C/U
2520189	ESF.C/SOMBRERO GRANDE 5/8	1	C/U



INTERMEDIOS

2520201	MEDIO NUDO ½	1	C/U
2520202	MEDIO NUDO 9/16	1	C/U
2520203	MEDIO NUDO 5/8	1	C/U
2520204	DOBLE LARGO ½	1	C/U
2520205	DOBLE LARGO 9/16	1	C/U
2520206	DOBLE MEDIANO ½	1	C/U



2520207	DOBLE MEDIANO 9/16	1	C/U
2520208	DOBLE MEDIANO 5/8	1	C/U
2520210	BARRIL ½	1	C/U
2520211	BARRIL 9/16	1	C/U
2520213	MEDIO NUDO CUADRADO ½	1	C/U
2520214	MEDIO NUDO CUADRADO 9/16	1	C/U
2520215	DOBLE CUADRADO CHICO ½	1	C/U
2520217	DOBLE CUADRADO GRANDE 1/2	1	C/U
2520218	DOBLE CUADRADO GRANDE 9/16	1	C/U
2520219	DOBLE CUADRADO GRANDE 5/8	1	C/U
2520221	MEDIO NUDO LABRADO ½	1	C/U
2520222	MEDIO NUDO LABRADO 9/16	1	C/U
2520223	MEDIO NUDO LABRADO GR. ½	1	C/U
2520224	MEDIO NUDO LABRADO GR. 9/16	1	C/U
2520225	MEDIO NUDO LABRADO GR. 5/8	1	C/U
2520226	DOBLE LABRADO 1/2	1	C/U
2520227	DOBLE LABRADO 9/16	1	C/U
2520228	DOBLE LABRADO 5/8	1	C/U



barril



PUNTAS Y APLIQUES DE HIERRO PARA REJAS

Código	Descripción	X Caja	U.M.
1190502	APLIQ. ½ REJA ART.79-36x37x17.5	1	C/U
1190503	APLIQ. ½ REJA ART.80-36x33	1	C/U
1190504	APLIQ. ½ REJA ART.81-40x35	1	C/U
1190606	ESFERA ART. 210-30x30	1	C/U
1190608	ESFERA ART. 211 C/BASE-30x28	1	C/U
1190612	ESFERA ART. 212 C/BASE-33x41	1	C/U
1190615	ESFERA ART. 213 C/BASE-34x47	1	C/U
Medidas en mm.			
1190523	LANZA ART. 100	1	C/U
1190534	LANZA ART. 105 VIKINGO	1	C/U
1190539	LANZA ART. 106 FLOR DE LIZ	1	C/U



79

80

81



211

210



100

106

105

PUNTAS DE REJA DE CHAPA

Código	Descripción	X Caja	U.M.
2385401	ART 80 PINO	1	C/U
2385402	ART 82 ROMBO	1	C/U
2385403	ART 83 ESPEJO	1	C/U
2385404	ART 85 FLOR DE LIZ	1	C/U
2385405	ART 86 CHINA	1	C/U
2385406	ART 87 VIENTO	1	C/U
2385407	ART 88 MUNDIAL	1	C/U
2385408	ART 90 REINA	1	C/U
2385409	ART 91 ALFIL	1	C/U
2385410	ART 92 RAYO	1	C/U
2385411	ART 94 PIRAMIDE	1	C/U



80

82

83

85



86

87

88

90



91

92

TAPAS PARA COLUMNAS

Código	Descripción	X Caja	U.M.
ALUMINIO			
2520303	ARABE REDONDA 3"	1	C/U
2520304	ARABE REDONDA 4"	1	C/U
2520308	ESFERA CON CUELLO 2 1/2"	1	C/U
2520309	ESFERA CON CUELLO 3"	1	C/U
2520310	PIRÁMIDE 50X50	1	C/U
2520311	PIRÁMIDE 60X60	1	C/U
2520312	PIRÁMIDE 70X70	1	C/U
2520313	PIRÁMIDE 80X80	1	C/U
2520314	PIRÁMIDE 100X100	1	C/U
2520315	PIRÁMIDE CON BOCHA 60X60	1	C/U
2520316	PIRÁMIDE CON BOCHA 70X70	1	C/U
2520317	PIRÁMIDE CON BOCHA 80X80	1	C/U
HIERRO (CHAPA)			
3840601	MEDIA ESFERA 64 MM	1	C/U
3840602	MEDIA ESFERA 80 MM	1	C/U
3840603	MEDIA ESFERA 90 MM	1	C/U
3840604	MEDIA ESFERA 100 MM	1	C/U
3840605	MEDIA ESFERA 133 MM	1	C/U
2385414	PIRAMIDE BAJA 60 X 60	1	C/U
2385415	PIRAMIDE BAJA 80 X 80	1	C/U
2385416	PIRAMIDE BAJA 100 X 100	1	C/U
3840800	PIRÁMIDE 50 X 50	1	C/U
3840801	PIRÁMIDE 60 X 60	1	C/U
3840802	PIRÁMIDE 70 X 70	1	C/U
3840803	PIRÁMIDE 80 X 80	1	C/U
3840804	PIRÁMIDE 90 X 90	1	C/U
3840805	PIRÁMIDE 100 X 100	1	C/U
3840806	PIRAMIDE CONICA 76 MM	1	C/U
3840807	PIRAMIDE CONICA 104 MM	1	C/U

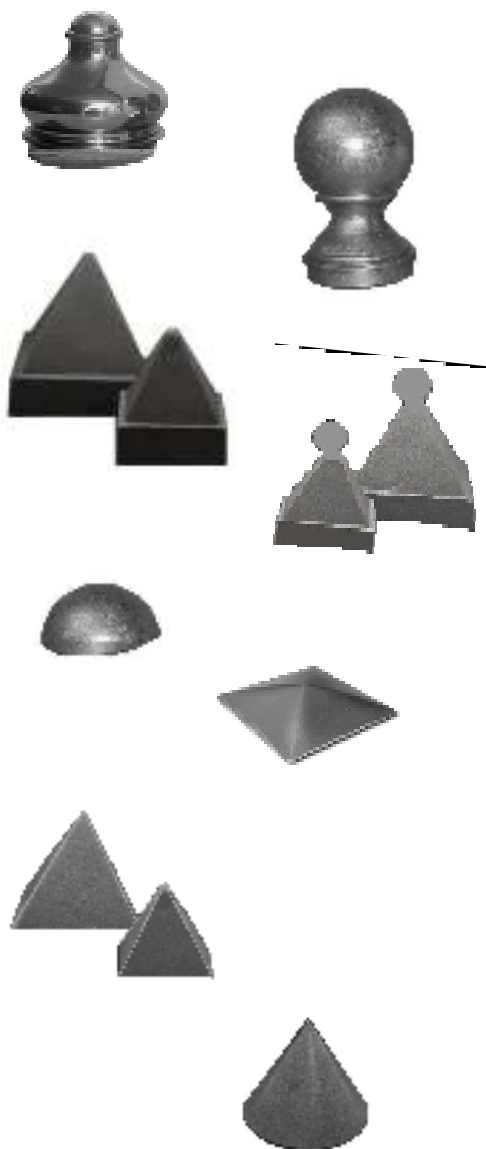

PROTECCIÓN PARA MUROS

Código	Descripción	X Caja	U.M.
1195050	TIRA DE UN METRO- 8 FLORES	1	C/U
1195052	FLOR PARA SOLDAR	1	C/U
1195054	FLOR PARA AMURAR	1	C/U
1195060	TIRA "DIENTE DE TIBURÓN" DE UN METRO	1	C/U













Tira de pinches





Diente de tiburón

ADORNOS Y APLIQUES

Código	Descripción	X Caja	U.M.		
ALUMINIO					
1190516	ESTRELLA CHICA ALUMINIO	1	C/U		Estrella
2520601	ROSETA CHICA	1	C/U		chica
2520603	ROSETA GRANDE	1	C/U		grande
2520605	MARGARITA CHICA	1	C/U		Marg.chica
2520607	MARGARITA GRANDE	1	C/U		Marg.grande
2520609	GIRASOL CHICO	1	C/U		girasol
2520611	GIRASOL GRANDE	1	C/U		
HIERRO					
1190513	APLIQUE FLOR DE LIZ	1	C/U		Flor de liz
1190518	APLIQUE FLOR ART 92	1	C/U		92
1190519	APLIQUE FLOR ART 93	1	C/U		93
1190520	APLIQUE FLOR ART 94	1	C/U		94

CAJA PORTACERRADURAS Y RUEDAS

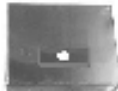
Código	Descripción	X Caja	U.M.		
3840401	CAJA PORTACERROJO	1	C/U		
3840402	CAJA 25 MM AJ PRIVE 200	1	C/U		
3840403	CAJA 25 MM AJ ACYTRA 101	1	C/U		
3840404	CAJA 30 MM AJ PRIVE 200	1	C/U		
3840405	CAJA 30 MM AJ ACYTRA 101	1	C/U		
3840501	CAJA ANGOSTA (5002)	1	C/U		
3840502	CAJA P/RUEDA 60	1	C/U		
3840503	CAJA P/RUEDA 75	1	C/U		
3840504	CAJA P/RUEDA 100	1	C/U		

TAPAS PARA BUZON

Código	Descripción	X Caja	U.M.
2493201	STANDARD BCE. PULIDO	1	C/U
2493231	STANDARD BCE. PLATIL	1	C/U
2590140	65X218 ACERO - MARCO NEGRO	1	C/U
2590142	75X255 ACERO - MARCO NEGRO	1	C/U
2125601	75x200 RECTA-LISA BCE. LACA	1	C/U
2125602	75x250 RECTA-LISA BCE. LACA	1	C/U
2125603	100x305 RECTA-LISA BCE. LACA	1	C/U
5880325	100X300 ACERO INOXIDABLE	1	C/U



BUZONES PARA APLICAR

Código	Descripción	X Caja	U.M.
REJA CON LLAVIN			
1174001	270X200X95 GRIS -TAPA ACERO (a)	1	C/U
1174002	300X200X100 GRIS T/AC C/GRAMPA	1	C/U
2590101	280X200X75 NEGRO TAPA ACERO	1	C/U
25901010	280X200X75 VERDE TAPA ACERO	1	C/U
2590102	350X200X100 NEGRO TAPA ACERO	1	C/U
25901020	350X200X100 VERDE TAPA ACERO	1	C/U
REJA CON CERRADURA			
2590107	280X200X75 NEGRO STD T/ ACERO	1	C/U
25901070	280X200X75 VERDE STD T/ ACERO	1	C/U
2590108	350X200X100 NEGRO STD T/ ACERO	1	C/U
25901080	350X200X100 VERDE STD T/ ACERO	1	C/U
1174017	400X330X105 NEGRO T/BRONCE (a)	1	C/U
1174018	400X330X105 NEGRO T/PLATIL	1	C/U
PUERTA CON LLAVIN			
2590119	280X200X75 NEGRO TAPA ACERO	1	C/U
25901190	280X200X75 VERDE TAPA ACERO	1	C/U
2590120	350X200X100 NEGRO TAPA ACERO	1	C/U
25901200	350X200X100 VERDE TAPA ACERO	1	C/U
PUERTA CON CERRADURA			
2590122	280X200X75 NEGRO TAPA ACERO	1	C/U
25901220	280X200X75 VERDE TAPA ACERO	1	C/U
2590123	350X200X100 NEGRO TAPA ACERO	1	C/U
25901230	350X200X100 VERDE TAPA ACERO	1	C/U
PARED CON CERRADURA			
2590133	280X200X75 NEGRO TAPA ACERO	1	C/U
25901330	280X200X75 VERDE TAPA ACERO	1	C/U
2590134	350X200X100 NEGRO TAPA ACERO	1	C/U
25901340	350X200X100 VERDE TAPA ACERO	1	C/U
11740170	400X330X105 NEGRO TAPA BRONC	1	C/U
11740180	400X330X105 NEGRO TAPA PLATIL	1	C/U
GRAMPAS PARA FIJAR BUZONES			
1174101	PARA BUZON ECO	1	C/U
2590144	PARA BUZON REJA VERDE	1	C/U
25901440	PARA BUZON REJA NEGRO	1	C/U



(a)

Con grampa

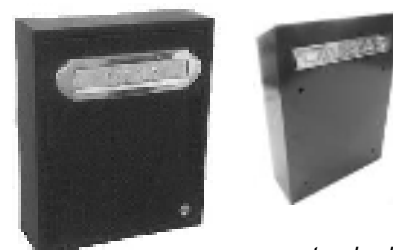

(a)

standard

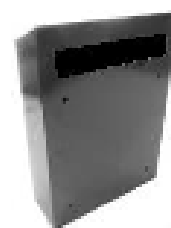

Para puerta



OBS: CON TIMBRE O AGUJERO COMMMAX:
ACLARARLO AL PEDIR.

BUZONES DE EMBUTIR

Código	Descripción	X Caja	U.M.
1174013	250X250X145 FTE PINT. TAPA TRASERA	1	C/U
1174014	250X250X145 FTE INOX TAPA TRASERA	1	C/U
1174015	310X280X145 FTE PINT. TAPA FRONTAL	1	C/U
1174016	310X280X145 FTE INOX TAPA FRONTAL	1	C/U



Tapa frontal

BUZONES CON PIE

Código	Descripción	X Caja	U.M.
RECTANGULAR CON CERRADURA			
2590151	200X215X310 FTE.PINT. TAPA ACERO	1	C/U
2590152	200X215X310 FTE.PINT. TAPA BRONC	1	C/U
2590145	200X215X310 FRENTE ACERO	1	C/U
2590146	200X215X310 FRENTE BRONCE	1	C/U
CASITA CON LLAVÍN			
2590176	180X230X215 TAPA ACERO	1	C/U
2590172	180X230X215 TAPA ACERO Y PUSADOR	1	C/U
2590170	180X230X215 FRENTE ACERO	1	C/U
2590177	180X230X215 FRENTE ACERO Y PULS.	1	C/U
CASITA CON CERRADURA			
2590175	180X230X215 TAPA ACERO	1	C/U
2590171	180X230X215 TAPA ACERO Y PUSADOR	1	C/U
2590169	180X230X215 FRENTE ACERO	1	C/U
2590178	180X230X215 FRENTE ACERO Y PULS.	1	C/U
CASITA ECONOMICA			
2540120	FRENTE PINTADO	1	C/U
2540121	FRENTE ACERO	1	C/U
REVISTEROS CON FRENTE PORTERO			
1174039	450X315X200 TAPA CROMADO (a)	1	C/U
1174040	450X315X200 TAPA BRONCE	1	C/U
1174043	500X330X300 TAPA CROMADO (b)	1	C/U
1174044	500X330X300 TAPA BRONCE	1	C/U

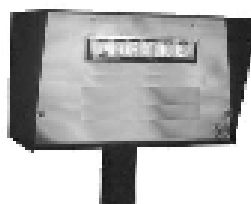

(a)

(b)

BUZONES LABRADOS DE FIBERGLASS

3820101	"PALOMA CHICO"	1	C/U
3820102	"PALOMA GRANDE"	1	C/U
3820103	RECTANGULAR	1	C/U
3820110	PIE PARA BUZON	1	C/U
3820104	FRENTE SOLO CHICO	1	C/U
3820105	FRENTE SOLO GRANDE	1	C/U
3820106	FRENTE SOLO RECTANGULAR	1	C/U



grande

chico

rectangular



OBS: EL BUZON GRANDE PUEDE PROVEERSE CON AGUJERO COMMAX. (FAVOR DE ACLARARLO)
COLORES: PATINADO VERDE, GRIS O TODO NEGRO

COFRES PORTAVALORES



Código	Descripción	X Caja	U.M.
3150101	NRO. 0 15X12X8	1	C/U
3150102	NRO. 1 20X16X9	1	C/U
3150103	NRO. 2 25X18X9	1	C/U
3150104	NRO. 3 29X21X8	1	C/U



CAJAS PORTALLAVEROS

Código	Descripción	X Caja	U.M.
1390401	NRO. 1 255X185X75 (24 LLAVEROS)	1	C/U
1390402	NRO. 2 310X230X80 (48 LLAVEROS)	1	C/U
1390403	NRO. 3 310X230X80 (90 LLAVEROS)	1	C/U



BANDEJAS PARA DINERO

Código	Descripción	X Caja	U.M.
3000320	GAVETA N°3 6,5 X 18.5 X 25.5	1	C/U
3000321	GAVETA N°4 10 X 33,5 X 37,5	1	C/U
3000322	GAVETA N°5 12 X 41 X 43	1	C/U
OBS: Son para poner dentro de un cajon			
3000303	CAJON COMPLETO CON 5 DIVISIONES	1	C/U



gaveta



cajon

CAJAS FUERTES DISIMULADAS (TIPO ENCHUFE)

Código	Descripción	X Caja	U.M.
1390101	TESORO LUZ 133 SIMPLE	1	C/U
1390105	TESORO LUZ 533 SIMPLE PROF.20	1	C/U
1390102	TESORO LUZ 233 DOBLE	1	C/U
1390103	TESORO LUZ 333 TRIPLE	1	C/U
1390106	TESORO LUZ 633 SIMPLE D/CAJON	1	C/U

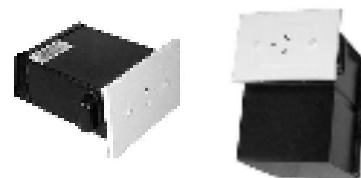

133

233



533



333



633



CAJAS DE SEGURIDAD

Código	Descripción	X Caja	U.M.
CON LLAVE SOLAMENTE			
1390120	BLINDADO PLACARD 13X23	1	C/U
1390121	BLINDADO PLACARD 20X23	1	C/U
1390122	BLINDADO PLACARD 20X30	1	C/U
1390123	BLINDADO PLACARD 25X35	1	C/U
1390124	BLINDADO PLACARD 30X40	1	C/U
1390125	BLINDADO PLACARD 40X40	1	C/U
1390150	DE EMPOTRAR 13x23	1	C/U
1390151	DE EMPOTRAR 20x23	1	C/U
1390152	DE EMPOTRAR 20x30	1	C/U
1390153	DE EMPOTRAR 25x35	1	C/U
1390154	DE EMPOTRAR 30x40	1	C/U
1390155	DE EMPOTRAR 40x40	1	C/U



CON LLAVE Y SECRETO NUMERICO			
13901220	BLINDADO PLACARD 20X30 C/SECR.	1	C/U
13901230	BLINDADO PLACARD 25X35 C/SECR	1	C/U
13901240	BLINDADO PLACARD 30X40 C/SECR.	1	C/U
13901250	BLINDADO PLACARD 40X40 C/SECR.	1	C/U
13901520	DE EMPOTRAR 20x30 C/SECR.NUM	1	C/U
13901530	DE EMPOTRAR 25x35 C/SECR.NUM.	1	C/U
13901540	DE EMPOTRAR 30x40 C/SECR.NUM	1	C/U
13901550	DE EMPOTRAR 40x40 C/SECR.NUM.	1	C/U

CAJAS BLINDADAS PARA TRANSPORTE			
1390201	13X23 CON RANURA	1	C/U
1390202	20X23 CON RANURA	1	C/U
1390203	13X23	1	C/U
1390204	20X23	1	C/U

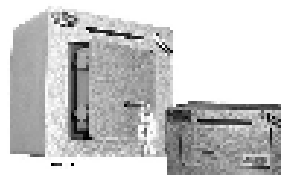

Con ranura

CAJAS CON TECLADO			
1390180	BLINDADO PLACARD 20X31	1	C/U
1390181	BLINDADO PLACARD 25X35	1	C/U
1390182	BLINDADO PLACARD 30X40	1	C/U
1390183	BLINDADO PLACARD 40X40	1	C/U
1390170	DE EMPOTRAR 33X21	1	C/U
1390171	DE EMPOTRAR 33X25	1	C/U
1390172	DE EMPOTRAR 40X30	1	C/U
1390173	DE EMPOTRAR 40X40	1	C/U
1390190	HOTELERA DE AMURAR 21X31	1	C/U
1390191	HOTELERA DE EMPOTRAR 21X31	1	C/U

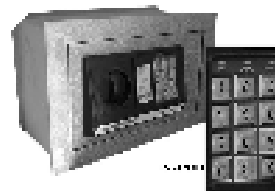



MIRADOR OPTICO ANGULAR

Código	Descripción	X Caja	U.M.
9043075	180' BRONCE PULIDO	12	C/U
9043076	180' BRONCE PLATIL MATE	12	C/U
3061001	180' PLASTICO CROMADO	50	C/U
3061002	180' PLASTICO DORADO	50	C/U



ADAPTADOR PARA MIRADOR

Código	Descripción	X Caja	U.M.
3010314	PLASTICO CROMADO	25	JUEGO
3010315	PLASTICO DORADO	25	JUEGO
3010316	BRONCE PULIDO	25	JUEGO
3010317	BRONCE PLATIL	25	JUEGO



MIRADOR PUERTA – CALLE

Código	Descripción	X Caja	U.M.
2492501	MIRAD.PUERTA CALLE PULIDO	20	JUEGO
24925010	MIRAD.PUERTA CALLE PLATIL	20	JUEGO

OBS.: Juego compuesto por un marco con puerta y un marco con rejilla



MARCO PARA ASCENSOR

Código	Descripción	X Caja	U.M.
2630050	SIN COLUMNAS PULIDO	1	C/U
26300500	SIN COLUMNAS PLATIL	1	C/U
2630051	UNA COLUMNA PULIDO	1	C/U
26300510	UNA COLUMNA PLATIL	1	C/U
2630052	DOS COLUMNAS PULIDO	1	C/U
26300520	DOS COLUMNAS PLATIL	1	C/U



Dos columnas

REJILLAS DE VENTILACION

Código	Descripción	X Caja	U.M.
3081603	40 MM REDONDA BRONCEADA	1	C/U
3081604	50 MM REDONDA BRONCEADA	1	C/U
3081601	40 MM REDONDA NIQUELADA	1	C/U
3081602	50 MM REDONDA NIQUELADA	1	C/U
3760850	17 X 17 CM PLASTICA BLANCA	1	C/U
3760851	30X13.5 CM PLASTICA BLANCA	1	C/U
2434112	RESPIRADERO DISIMULADO PULIDO		
24341120	RESPIRADERO DISIMULADO PLATIL		



NUMEROS

Código

N*	BRONCE 58 MM		BRONCE 70 MM		U.M.
	PUL	PLAT	PUL	PLAT	
0	3850101	385010110	3850102	385010210	C/U
1	385010101	385010111	385010201	385010211	C/U
2	385010102	385010112	385010202	385010212	C/U
3	385010103	385010113	385010203	385010213	C/U
4	385010104	385010114	385010204	385010214	C/U
5	385010105	385010115	385010205	385010215	C/U
6/9	385010106	385010116	385010206	385010216	C/U
7	385010107	385010117	385010207	385010217	C/U
8	385010108	385010118	385010208	385010218	C/U



58 mm



70 mm

N*	BRONCE 108 MM		ACERO INOX		U.M.
	PUL	PLAT	120 MM		
0	2630027	26300270	9041950		C/U
1	263002711	26300271	9041951		C/U
2	263002712	26300272	9041952		C/U
3	263002713	26300273	9041953		C/U
4	263002714	26300274	9041954		C/U
5	263002715	26300275	9041955		C/U
6/9	263002716	26300276	9041956		C/U
7	263002717	26300277	9041957		C/U
8	263002718	26300278	9041958		C/U



108 mm



Acero inox.

	SIMIL FORJADO		FIBRA		U.M.
	70 MM NEGRO		70 MM DORADO		
0	2128001		3820220		C/U
1	2128002		38202201		C/U
2	2128003		38202202		C/U
3	2128004		38202203		C/U
4	2128005		38202204		C/U
5	2128006		38202205		C/U
6	2128007		38202206		C/U
7	2128008		38202207		C/U
8	2128009		38202208		C/U
9	2128010		38202209		C/U



Simil forjado



Fibra

LETRAS

	BRONCE 40 MM		BRONCE 60 M		U.M.
	PULIDO	PLATIL	PULIDO	PLATIL	
A	2630010	26300100	3850103	3850104	C/U
B	26300101	26300106	38501030	38501040	C/U
C	26300102	26300107	38501031	38501041	C/U
D	26300103	26300108	38501032	38501042	C/U
E	26300104	26300109	38501033	38501043	C/U
F	26300105	26300110	38501034	38501044	C/U



OBS: Por otras letras ,consultar.

BRONCE 108 MM

	PULIDO	PLATIL	U.M.
P	2630013	26300130	C/U
B	26300131	26300134	C/U
S	26300132	26300135	C/U

OBS: Por otras letras, consultar.

2630015	PALABRA ENCARGADO BCE PULIDO	C/U
26300150	PALABRA ENCARGADO BCE PLATIL	C/U



INDICADORES PARA BAÑO

Código	Descripción	X Caja	U.M.
SILUETAS			
2434101	SILUETA CABALLERO BCE PULIDO	1	C/U
24341010	SILUETA CABALLERO BCE PLATIL	1	C/U
2434102	SILUETA DAMA BCE PULIDO	1	C/U
24341020	SILUETA DAMA BCE PLATIL	1	C/U
CARTELES			
2126401	DAMAS BRONCE PULIDO	1	C/U
2126402	CABALLEROS BRONCE PULIDO	1	C/U
2126403	TOILET BRONCE PULIDO	1	C/U
9041972	DAMA ACERO INOXIDABLE	1	C/U
9041971	CABALLERO ACERO INOXIDABLE	1	C/U
9041970	MINUSVALIDO ACERO INOXIDABLE	1	C/U

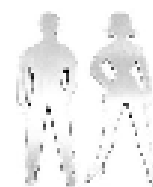

Acero inox.
Diametro 76 mm

CORAZAS LIBRE-OCUPADO

Código	Descripción	X Caja	U.M.
2431301	CUADRADA ACERO	25	JUEGO
2431303	CUADRADA BR.PULIDO	25	JUEGO
1281701	REDONDA CINCADA	10	JUEGO
1281702	REDONDA BR.PULIDO	10	JUEGO
1281703	REDONDA BR.PLATIL	10	JUEGO

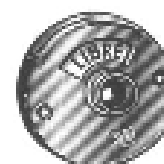

TOPES PARA PUERTAS

Código	Descripción	X Caja	U.M.
2060402	CILINDRICO Nº 1 – 20 X 20	50	C/U
2060403	CILINDRICO Nº 2 – 25 X 25	50	C/U
2060404	CILINDRICO Nº 3 – 27 X 27	50	C/U
2060405	CILINDRICO Nº 4 – 32 X 32	50	C/U
2060406	CILINDRICO Nº 5 – 28 X 38	50	C/U
2060407	CILINDRICO Nº 6 – 30 X 40	50	C/U
9043040	MEDIA ESFERA BRONCE PULIDO	12	C/U
9043041	MEDIA ESFERA BRONCE SATINADO	12	C/U



Cilindrico negro



Bronce



ZOCALOS DE ALUMINIO CON GOMA

Código	Descripción	X Caja	U.M.
3862201	ALUMINIO CON GOMA 0.60	1	C/U
3862202	ALUMINIO CON GOMA 0.70	1	C/U
3862203	ALUMINIO CON GOMA 0.80	1	C/U
3862204	ALUMINIO CON GOMA 0.90	1	C/U
3862205	ALUMINIO CON GOMA 1.00	1	C/U
3862206	ALUMINIO CON GOMA 0.60 BLANCO	1	C/U
3862207	ALUMINIO CON GOMA 0.70 BLANCO	1	C/U
3862208	ALUMINIO CON GOMA 0.80 BLANCO	1	C/U
3862209	ALUMINIO CON GOMA 0.90 BLANCO	1	C/U
3862210	ALUMINIO CON GOMA 1.00 BLANCO	1	C/U
9043320	ALUMINIO CON FELPA BLANCO	1	C/U
9043321	ALUMINIO CON FELPA MARRON	1	C/U

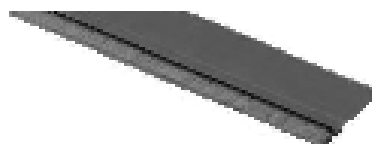
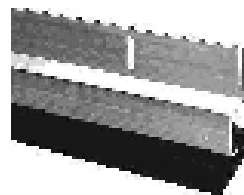

FLEJE PARA ALFOMBRA

Código	Descripción	X Caja	U.M.
2009996	RAYADO FLEXIBLE 25 MM X 1 MM	25	MT.



TOPES PARA PROTECCION DE PAREDES

Código	Descripción	X Caja	U.M.
TOPES DE GOMA 5 MM DE ESPESOR			
2991000	REDONDO 4 CM BLANCO x3 uds.	1	SET
2991001	RECTANG 3 X 8 CM BLAN x3 uds.	1	SET
TOPES DE 4 MM DE GOMA ESPESOR			
2990007	CIRCULAR DIAM 4 CM x6 uds.	1	SET
2990010	CIRCULAR DIAM 5 CM x4 uds.	1	SET
2990011	CUADRADO 4.5 CM x5 uds.	1	SET
OBS: Colores blanco o negro. (uds.por blíster)			
TOPES DE PVC 3 MM DE ESPESOR			
2992002	CIRCULAR DIAM 4 CM x3 uds.	1	SET
2992003	RECTANGULAR 3 CM X 8 CM x2 uds	1	SET
OBS: De pvc transparente (uds.por blíster)			



TEJIDO MOSQUITERO DE ALUMINIO

Código	Descripción	X rollo	U.M.
2240103	ANCHO 80 CM	30.5	MT.
2240104	ANCHO 90 CM	30.5	MT.
2240105	ANCHO 100 CM	30.5	MT.
2240106	ANCHO 120 CM	30.5	MT.
2240107	ANCHO 150 CM	30.5	MT.



GRAMPAS PARA FIJAR MARCOS

Código	Descripción	X Caja	U.M.
2700341	GRAMPA REFORZADA.	50	C/U



PERCHAS DE ALUMINIO

Código	Descripción	X Caja	U.M.
2960701	NATURAL DE UN GANCHO	60	C/U
2960702	NATURAL DE DOS GANCHOS	36	C/U
2960708	BLANCA DE UN GANCHO	60	C/U
2960709	NEGRA DE UN GANCHO	60	C/U
2960710	BLANCA DE DOS GANCHOS	36	C/U
2960711	NEGRA DE DOS GANCHOS	36	C/U



PERCHAS DE ZAMAK

Código	Descripción	X Caja	U.M.
3860101	PERCHITA VOILE DORADA	100	C/U
3860102	PERCHITA VOILE NIQUELADA	100	C/U



PERCHAS DE BRONCE FUNDIDO

Código	Descripción	X Caja	U.M.
2492603	STANDARD CHICA BCE PULIDO	1	C/U
2492602	STANDARD MEDIANA BCE PULIDO	1	C/U
2492601	STANDARD GRANDE BCE PULIDO	1	C/U
2492633	STANDARD CHICA BCE PLATIL	1	C/U
2492632	STANDARD MEDIANA BCE PLATIL	1	C/U
2492631	STANDARD GRANDE BCE PLATIL	1	C/U
2126200	PERCHA SIMPLE UN GANCHO	1	C/U
2126201	DOBLE VERTICAL 125 BASE OVAL	1	C/U
2126202	SIMPLE PARA SACO	1	C/U
2126203	UN GANCHO TIPO PITON	1	C/U
2126220	DOBLE VERTICAL 150 CALADA	1	C/U
2126221	DOBLE VERTICAL 110 BASE CUAD.	1	C/U
2126210	PERCHERO MULTIPLE 5 GANCHOS	1	C/U

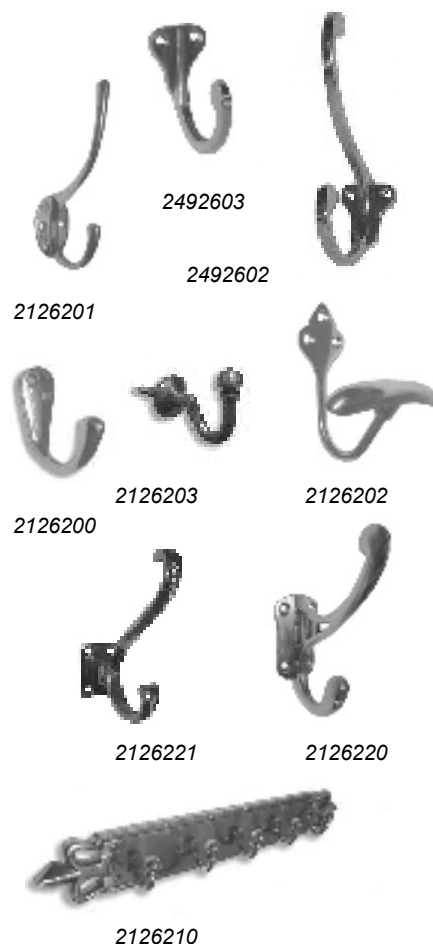

TENDEDEROS

Código	Descripción	X Caja	U.M.
3861201	EXTENSIBLE 45 CM – 9 VARILLAS	1	C/U
3861202	EXTENSIBLE 60 CM – 9 VARILLAS	1	C/U
3861203	EXTENSIBLE 80 CM – 9 VARILLAS	1	C/U
3861205	EXTENSIBLE 100 CM – 9 VARILLAS	1	C/U
3861207	EXTENSIBLE 60 CM – 7 VARILLAS	1	C/U



3861220	DE PIE SIMPLE 7 VARILLAS	1	C/U
3861221	DE PIE SIMPLE 8 VARILLAS	1	C/U
3861222	DE PIE SIMPLE 9 VARILLAS	1	C/U

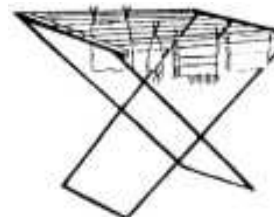

ROLDANAS PARA SOGAS

Código	Descripción	X Caja	U.M.
1020301	DIAMETRO 25 MM NIQUELADA	12	C/U
1020302	DIAMETRO 38 MM NIQUELADA	12	C/U
1020303	DIAMETRO 50 MM NIQUELADA	12	C/U
1020310	DIAMETRO 25 MM NYLON	12	C/U
1020311	DIAMETRO 32 MM NYLON	12	C/U
1020312	DIAMETRO 38 MM NYLON	12	C/U
1020313	DIAMETRO 50 MM NYLON	12	C/U



Toda niquelada



Nylon

SOPORTE TIPO COLONIAL

Código	Descripción	X Caja	U.M.
3540502	15 CM.	24	C/U
3540503	20 CM.	24	C/U
3540504	25 CM.	24	C/U
3540505	30 CM.	24	C/U



MENSULAS DE CHAPA

Código	Descripción	X Caja	U.M.
NEGRO	BLANCO	Medida	
9043208	9043201	100x125	20 C/U
9043209	9043202	125x150	20 C/U
9043210	9043203	150x200	20 C/U
9043211	9043204	200x250	20 C/U
9043212	9043205	250x300	20 C/U
9043213	9043206	300x350	20 C/U
9043214	9043207	350x400	20 C/U



SOPORTE "STRONG"

Código	Descripción	X Caja	U.M.
NEGRO	BLANCO	Medida	
22203060	2220306	100X150	24 C/U
22203070	2220307	150X200	24 C/U
22203080	2220308	200X250	24 C/U
22203090	2220309	250X300	24 C/U

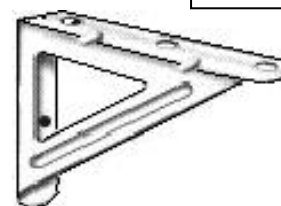

MENSULA BRACKET

Código	Descripción	X Caja	U.M.
NEGRO	BLANCO	Medida	
22203500	2220350	100X150	20 C/U
22203510	2220351	150X200	20 C/U
22203520	2220352	200X250	20 C/U
22203530	2220353	250X300	20 C/U
22203540	2220354	300 X350	20 C/U



MENSULAS PARA MESADAS

Código	Descripción	X Caja	U.M.
2470101	40 CM EPOXI BLANCO	12	C/U
2470102	50 CM EPOXI BLANCO	12	C/U
3540701	35 CM NEGRA	12	C/U
3540702	48 CM NEGRA	12	C/U

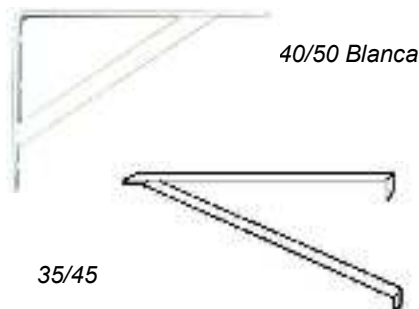

RIELES Y MENSULAS PARA ESTANTES



Código	Descripcion			X Caja	U.M.
RIELES DE DOS RANURAS					
NEGRO	BLANCO	GRIS			
2230101	2230121	2230150	1.00 MT	10	C/U
2230102	2230122	2230151	1.50 MT.	10	C/U
2230103	2230123	2230152	2.00 MT.	10	C/U
MENSULAS					
2230110	2230130	2230155	10 CM.	20	C/U
2230111	2230131	2230156	17 CM.	20	C/U
2230112	2230132	2230157	27 CM.	20	C/U
2230113	2230133	2230158	37 CM.	20	C/U
2230116	2230134	2230159	44 CM.	10	C/U
2230117	2230135	2230160	54 CM.	10	C/U



MINI RIEL Y MENSULA

Código	Descripcion	X Caja	U.M.
2232001	MINI RIEL CINCADO X 2 MTS	10	C/U
2232010	MINI MENSULA 2.5 CMTS	24	C/U

OBS: En hierro cincado azul

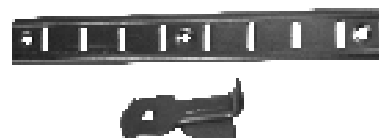

ACCESORIOS PARA PANEL RANURADO

Código	Descripcion	X Caja	U.M.
2237001	BLISTERO 4 X 100	50	C/U
2237002	BLISTERO 4 X 150	50	C/U
2237003	BLISTERO 4 X 200	50	C/U
2237006	BLISTERO 6 X 300	50	C/U
2237021	MENSULA DE CAÑO 150 MM	12	C/U
2237022	MENSULA DE CAÑO 200 MM	12	C/U
2237023	MENSULA DE CAÑO 300 MM	12	C/U



RIELES Y MENSULAS PLANAS

Código	Descripción		X Caja	U.M.
BLANCO	NEGRO			
2230215	2230255	10 CM.	10	C/U
2230217	2230256	20 CM.	10	C/U
2230220	2230257	25 CM.	10	C/U
2230221	2230258	30 CM.	10	C/U
2230211	2230251	RIEL X 1 MT.	2	C/U
2230212	2230252	RIEL X 1.5 MT.	2	C/U
2230213	2230253	RIEL X 2 MT.	2	C/U



SOPORTES OCULTOS

Código	Descripción	X Caja	U.M.
2470103	LARGO 24 CM	12	C/U
2470104	LARGO 15 CM	12	C/U

OBS: Varilla exagonal de 10 mm con taco de 12





SOPORTES LATERALES

Código	Descripción	X Caja	U.M.
PLANOS			
2220303	200 MM BLANCO	12	C/U
2220304	300 MM BLANCO	12	C/U
2220305	400 MM BLANCO	12	C/U
22203030	200 MM NEGRO	12	C/U
22203040	300 MM NEGRO	12	C/U
22203050	400 MM NEGRO	12	C/U
"RAPI - REP"			
2235020	P/ESTANTE DE 30 CM BLANCO	6	PAR
22350201	P/ESTANTE DE 30 CM NEGRO	6	PAR
22350202	P/ESTANTE DE 30 CM MARRON	6	PAR
22350203	P/ESTANTE DE 30 CM ROJO	6	PAR
2235021	P/ESTANTE DE 40 CM BLANCO	6	PAR
22350210	P/ESTANTE DE 40 CM NEGRO	6	PAR
22350211	P/ESTANTE DE 40 CM MARRON	6	PAR
22350212	P/ESTANTE DE 40 CM ROJO	6	PAR
"AERO BASICA"			
2235022	AERO BASICA GRIS ALUMINIO	12	C/U
2235023	AERO BASICA BLANCA	12	C/U
2235024	AERO BASICA NEGRA	12	C/U



MENSULA REBATIBLE

Código	Descripción	X Caja	U.M.
DE DOS POSICIONES (45° Y 90°)			
2210311	BLANCA	1	PAR
2210310	NEGRA	1	PAR
DE UNA POSICION			
2127120	15 CM. BLANCA	1	PAR
2127121	20 CM. BLANCA	1	PAR
2127122	30 CM. BLANCA	1	PAR
2127123	40 CM. BLANCA	1	PAR

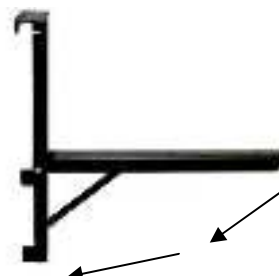

SOPORTES PARA ESTANTES DE VIDRIO

Código	Descripción	X Caja	U.M.
PULIDO PLATIL			
2650301	2650310 6 MM CHICO	20	C/U
2650302	2650311 6 MM GRANDE	20	C/U
2650303	2650312 10 MM	20	C/U
3600520	3600521 15 MM	10	C/U
3600522	3600523 20 MM	10	C/U





SOPORTES COCODRILO

Código	Descripción	X Caja	U.M.
"THE RACK"			
2220310	N: 1 – CHICO BLANCO	6	PAR
22203100	N: 1 – CHICO NEGRO	6	PAR
2220311	N: 2 – GRANDE BLANCO	6	PAR
22203110	N: 2 – GRANDE NEGRO	6	PAR
M H A			
9043080	CHICO DORADO	10	PAR
9043081	GRANDE DORADO	10	PAR
9043082	CHICO SATINADO	10	PAR
9043083	GRANDE SATINADO	10	PAR
9043084	CHICO CROMADO	10	PAR
9043085	GRANDE CROMADO	10	PAR



chico



grande

SOPORTES PARA ESTANTERIAS CON CABLES DE ACERO

Código	Descripción	X Caja	U.M.
2660101	TENSOR ARTICULADO	C1	1 C/U
2660102	TENSOR RECTO	C2	1 C/U
2660103	SOPORTE PASANTE	M1	1 C/U
2660104	SOPORTE TERMINAL	M1T	1 C/U
2660105	ROSETA DE TERMINACION	M4	1 C/U
2660106	SOPORTE PANEL PERFORADO	M7	1 C/U
2660107	SOPORTE ESTANTE-PARED	M3	1 C/U
2660108	SOPORTE CABLE-CARTEL	M5	1 C/U
2660110	SOPORTE PANEL 3 MM	M9	1 C/U



C1



C2



M1



M1T



M4



M7



M3



M5



M9

APLICACIONES:

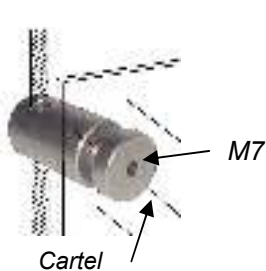
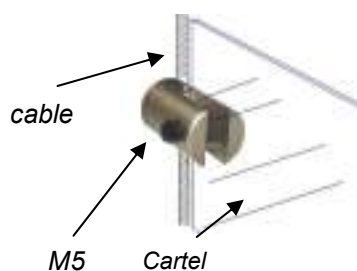
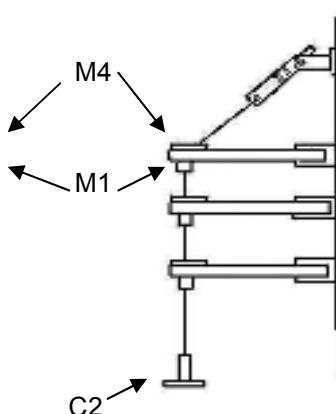
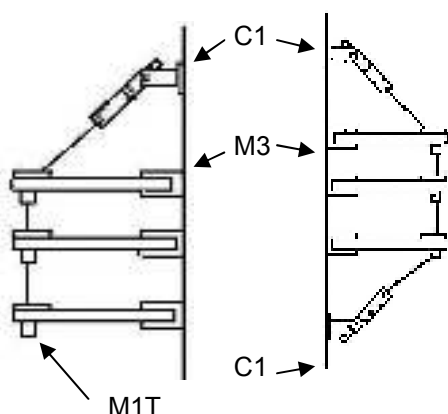

*Hay que tener en cuenta que los tensores vienen rosca derecha e izquierda. Para tensar correctamente el tensor de arriba debe ser de rosca contraria al de abajo.

SOPORTES PARA ELECTRODOMESTICOS

Código	Descripción	X Caja	U.M.
3540601	PARA AIRE ACONDICIONADO 42 CM	1	C/U
3540602	PARA AIRE ACONDICIONADO 52 CM	1	C/U
8500101	PARA TV HASTA 21"	1	C/U
8500102	PARA TV HASTA 21" Y VIDEO	1	C/U
2640101	LCD BASCULANTE 19"-32"	1	C/U
2640102	LCD BASCULANTE 33"-63"	1	C/U
2640103	LCD BASCULANTE EXTENSIB.19-32	1	C/U
2640106	LCD BASCULANTE EXTENSIB.33-63	1	C/U



basculante



Basculante y extensible

ESCUADRAS PARA ALACENA

Código	Descripción	X Caja	U.M.
2199001	PLANA (EXTERIOR) CINCADA	48	C/U
2199002	CON ALAS (INTERIOR) CINCADA	24	C/U
2220300	CON ALAS (INTERIOR) BLANCA	12	C/U

N°2

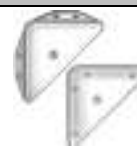

N°1

COLGADOR PARA ALACENAS

9125040	REVERSIBLE BLANCO	1	C/U
9125042	PLACA PARA COLGADOR	1	C/U



SOPORTES PARA REPISAS Y CUADROS

Código	Descripción	X Caja	U.M.
2190301	RECTANGULAR 45 MM. HIERRO	100	C/U
2190302	RECTANGULAR 75 MM. HIERRO	100	C/U
2190201	20 MM. BRONCEADO		CIEN
2190202	25 MM. BRONCEADO	1	CIEN
2190203	30 MM. BRONCEADO	1	CIEN
2190204	35 MM. BRONCEADO	1	CIEN
2190205	45 MM. BRONCEADO	1	CIEN
2190206	55 MM. BRONCEADO	1	CIEN
2190101	N° 0 BRONCEADO (CHICO)	2	CIEN
2190102	N° 1 BRONCEADO	2	CIEN
2190103	N° 2 BRONCEADO	2	CIEN
2190104	N° 3 BRONCEADO (GRANDE)	2	CIEN

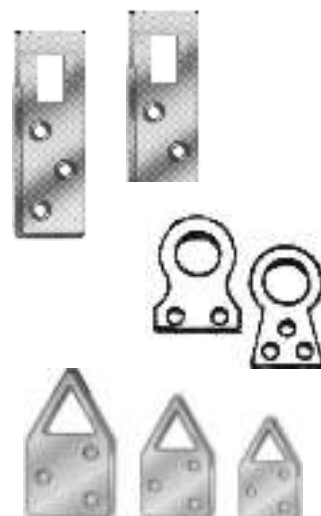

SOPORTES METALICOS

Código	Descripción	X Caja	U.M.
2360102	ESCUADRA BRONCEADO	2	CIEN
2360101	MACIZO BRONCEADO	1	CIEN
2360103	TUBO BRONCEADO	3	CIEN
2110901	DIÁMETRO 5 MM. NIQUELADO	1	CIEN
2110902	DIÁMETRO 5 MM. BRONCEADO	1	CIEN
2110903	DIAMETRO 5 MM. NEGRO	1	CIEN



SOPORTES PLASTICOS

Código	Descripción	X Caja	U.M.
2200745	SOPORTE PLASTICO BLANCO	1	CIEN
22007450	SOPORTE PLASTICO MARRON	1	CIEN
22007451	SOPORTE PLASTICO NEGRO	1	CIEN
2200746	TUBO PLASTICO BLANCO	3	CIEN
22007460	TUBO PLASTICO MARRON	3	CIEN
22007461	TUBO PLASTICO NEGRO	3	CIEN
9125001	CON PERNO 5 MM TRANSPARENTE	1	CIEN
9125002	CON PERNO 5 MM BLANCO	1	CIEN
9125003	CON PERNO 5 MM MARRON	1	CIEN
9125004	CON PERNO 5 MM NEGRO	1	CIEN

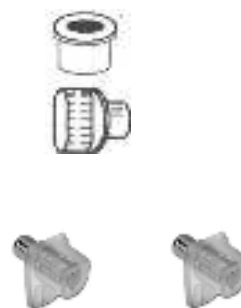

ESCUADRAS TRIANGULARES CON TAPA

3760109	TRANSPARENTE	2.5	CIEN
3760110	BLANCO	2.5	CIEN
3760111	ALMENDRA	2.5	CIEN
3760112	HAYA	2.5	CIEN
3760113	HAYA NATURAL	2.5	CIEN
3760114	MARFIL	2.5	CIEN
3760115	CEREZO	2.5	CIEN
3760116	MARRON CLARO	2.5	CIEN
3760117	MARRON OSCURO	2.5	CIEN
3760118	NEGRO	2.5	CIEN
3760119	GRIS CLARO	2.5	CIEN



SOPORTES PARA VIDRIOS Y ESPEJOS

Código		Descripción	X Caja	U.M.
3600201	X 10 F	FIJO ANCHO P/4 MM	100	C/U
3600202	X 10 C	CORR.ANCHO P/4 MM.	100	C/U
3600203	X 13 F	FIJO ANG.P/4 MM.	100	C/U
3600204	X 13 C	CORR.ANG.P/4 MM.	100	C/U
3600205	X 14 F	FIJO ANG.P/6 MM.	100	C/U
3600206	X 14 C	CORR.ANG.P/6 MM.	100	C/U
3600401	X 26 P	P/DOBLE VIDRIO (CHICO)	100	C/U
3600402	X 26 G	P/DOBLE VIDRIO (GRANDE)	100	C/U
3600404	X26 D	P/DOB.VID. DOBLE PEST.	100	C/U
3600410	X40	"U" C/TORNILLO Y AGUJERO	100	C/U
3600409	X40	"U" C/TORNILLO SIN AGUJERO	100	C/U
3600302	X 36	"Z" P/4 MM.ANCHO 13 MM.	100	C/U
3600303	X 35	"Z" P/6 MM.ANCHO 15 MM.	100	C/U
3600304	X 33	"Z" P/6 MM.ANCHO 19 MM.	100	C/U
3600501	X 17	"L" ANGOSTO 1 AGUJERO	100	C/U
3600502	X 18	"L" ANGOSTO	100	C/U
3600503	X 20	"L" ANCHO 2 AGUJEROS	100	C/U
3600504	X 21	"L" CORTO	100	C/U
3600505	X 24	"L" ANCHO 1 AGUJERO	100	C/U
3600506	X 25	"L" ANCHO 1 AGUJERO	100	C/U
3350220	X24	"L" ANCHO 1 AG. BRONCE		

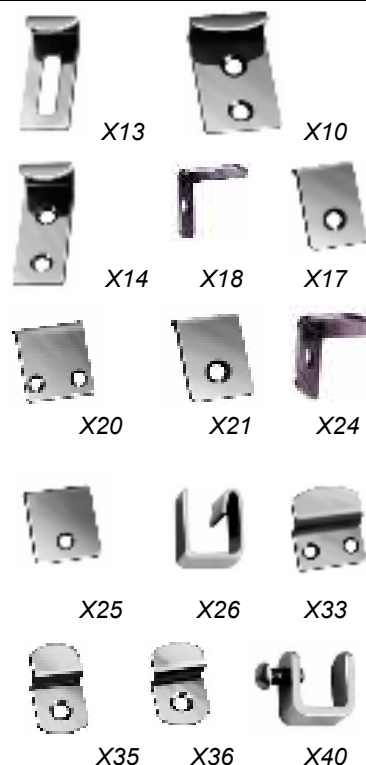

ESQUINEROS P/CRISTAL

Código		Descripción	X Caja	U.M.
2190320	ACERO C/TAPA	30X30X19	100	C/U
3600601	ACERO X6	25X25X16	100	C/U
3600604	ACERO X8	25X25X13	100	C/U
3350205	ACERO N.9	41X41	100	C/U
2190311	HIERRO NIQUELADO	25X25X13	50	C/U
2190310	HIERRO BRONCEADO	25X25X13	50	C/U
3350212	BRONCE ART.7 C/TAPA	25X25X16	50	C/U
3350214	BRONCE ART.8	25X25X13	50	C/U
3350210	BRONCE ART.5	23X23X19	50	C/U
3350216	BRONCE ART.77 C/TAPA	30X30X16		

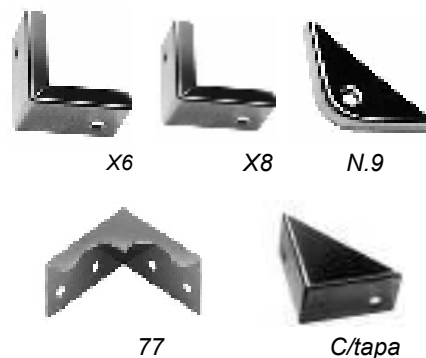

SOPORTES EXAGONALES

Código		Descripción	X Caja	U.M.
3351005	SOPORT. EXAG.	BRONCE PULIDO	100	C/U
3351006	SOPORT. EXAG.	BRONCE PLATIL	100	C/U



BOTONES PARA VIDRIO

Código		Descripción	X Caja	U.M.
3350501	DIAM.24 MM.	ROSCA 3/16X23 MM	100	C/U



SOPORTES PARA PASAMANOS

Código	Descripción	X Caja	U.M.
BRONCE – PERFIL REDONDO			
2250701	PULIDO CURVO P/ TACO N.12	6	C/U
22507010	PLATIL CURVO P/TACO N.12	6	C/U
22507011	PULIDO CURVO C/BASE 3 AGUJ.	6	C/U
22507012	PLATIL CURVO C/BASE 3 AGUJ.	6	C/U
2250702	PULIDO PLANO P/TACO N.12	6	C/U
22507020	PLATIL PLANO P/TACO N.12	6	C/U
22507022	PULIDO PLANO C/BASE 3 AGUJ.	6	C/U
22507023	PLATIL PLANO C/BASE 3 AGUJ.	6	C/U
BRONCE - PERFIL CUADRADO			
2500322	PLANO P/ TACO N.12 PULIDO	6	C/U
25003220	PLANO P/TACO N.12 PLATIL	6	C/U
ACERO – PERFIL REDONDO			
9043310	PLANO PARA TACO N.12	6	C/U
HIERRO			
4021550	NEGRO PLANO PARA TACO N.12	6	C/U
4021551	NEGRO PLANO C/BASE 2 AGUJ.	6	C/U
4021552	NEGRO CURVO PARA TACO N.12	6	C/U
4021553	NEGRO CURVO C/BASE 2 AGUJ.	6	C/U
4021554	DORADO PLANO PARA TACO N.12	6	C/U
4021555	DORADO PLANO C/BASE 2 AGUJ.	6	C/U
4021556	DORADO CURVO PARA TACO N.12	6	C/U
4021557	DORADO CURVO C/BASE 2 AGUJ.	6	C/U



SOPORTES PARA BARRAS

Código	Descripción	X Caja	U.M.
CERRADOS PASANTES Y CON TAPA			
PULIDO	PLATIL		
3830005	38300050 PASANTE 1	1	C/U
3830006	38300060 PASANTE 1 1/4	1	C/U
3830007	38300070 PASANTE 1 1/2	1	C/U
3830008	38300080 PASANTE 2	1	C/U
3830014	38300140 TAPADO 1"	1	C/U
3830015	38300150 TAPADO 1 1/4"	1	C/U
3830016	38300160 TAPADO 1 1/2"	1	C/U
3830017	38300170 TAPADO 2"	1	C/U
SOPORTES LATERALES FIJOS			
2434004	24300400 1" BRONCE	50	C/U
3830071	38300710 1 ¼" BRONCE	1	C/U
3830072	38300720 1 ½" BRONCE	1	C/U
3830073	38300730 2" BRONCE	1	C/U
TAPAS DE BRONCE PARA CAÑOS			
3830052	38300520 TAPA CAÑO 1"	1	C/U
3830053	38300530 TAPA CAÑO 1 1/4"	1	C/U
3830054	38300540 TAPA CAÑO 1"1/2	1	C/U
3830055	38300550 TAPA CAÑO 2"	1	C/U



SOPORTES PARA TIRANTES

Código	Descripción	X Caja	U.M.
CAJAS PARA TIRANTES			
3540104	ABIERTA P/ TIRANTE 4" NEGRO	1	C/U
3540105	ABIERTA P/ TIRANTE 5" NEGRO	1	C/U
3540106	ABIERTA P/ TIRANTE 6" NEGRO	1	C/U
3540110	CERRADO P/TIRANTE 4" NEGRO	1	C/U
3540111	CERRADO P/TIRANTE 5" NEGRO	1	C/U
3540112	CERRADO P/TIRANTE 6" NEGRO	1	C/U
3540115	INDIVIDUAL A 90° 4" NEGRO	1	C/U
3540116	INDIVIDUAL A 90° 5" NEGRO	1	C/U
3540117	INDIVIDUAL A 90° 6" NEGRO	1	C/U
3540118	INDIVIDUAL A 90° 8" NEGRO	1	C/U
3540119	INDIVIDUAL A 30° 4" NEGRO	1	C/U
3540120	INDIVIDUAL A 30° 5" NEGRO	1	C/U
3540121	INDIVIDUAL A 30° 6" NEGRO	1	C/U
3540122	INDIVIDUAL A 30° INFER. 4" NEGRO	1	C/U
3540123	INDIVIDUAL A 30° INFER. 5" NEGRO	1	C/U
3540124	INDIVIDUAL A 30° INFER. 6" NEGRO	1	C/U
3540125	INDIVIDUAL A 45° 4" NEGRO	1	C/U
3540126	INDIVIDUAL A 45° 5" NEGRO	1	C/U
3540127	INDIVIDUAL A 45° 6" NEGRO	1	C/U
PLACAS PARA UNION DE TIRANTES			
3540130	PLACA UNION DE TIRANTES 2" NE	1	C/U
3540131	PLACA UNION DE TIRANTES 3" NE	1	C/U
3540132	PLACA UNION DE TIRANTES 4" NE	1	C/U
3540133	PLACA UNION DE TIRANTES 5" NE	1	C/U
3540134	PLACA UNION DE TIRANTES 6" NE	1	C/U
3540135	PLACA UNION DE TIRANTES 8" NE	1	C/U
3540165	UNION DE CUMBRERA 30° 4"	1	C/U
3540166	UNION DE CUMBRERA 30° 5"	1	C/U
3540167	UNION DE CUMBRERA 30° 6"	1	C/U
3540168	UNION DE CUMBRERA 45° 4"	1	C/U
3540169	UNION DE CUMBRERA 45° 5"	1	C/U
3540170	UNION DE CUMBRERA 45° 6"	1	C/U
ESCUADRAS DE UNION			
3540150	SOPORTE A 90° 2"	1	C/U
3540151	SOPORTE A 90° 3"	1	C/U
3540152	SOPORTE A 90° 4"	1	C/U
3540153	SOPORTE A 90° 5"	1	C/U
3540154	SOPORTE A 90° 6"	1	C/U
3540155	SOPORTE A 90° 7"	1	C/U
3540156	SOPORTE A 90° 8"	1	C/U
3540157	SOPORTE A 90° 9"	1	C/U
3540158	SOPORTE A 90° 10"	1	C/U
3540159	SOPORTE A 90° 12"	1	C/U
3540140	SOPORTE EN "L" 1 ½ " NEGRO	1	C/U
3540141	SOPORTE EN "L" 2" NEGRO	1	C/U
3540142	SOPORTE EN "L" 3" NEGRO	1	C/U



3540143	SOPORTE EN "L" 4" NEGRO	1	C/U
3540144	SOPORTE EN "L" 5" NEGRO	1	C/U
3540145	SOPORTE EN "L" 6" NEGRO	1	C/U
3540146	SOPORTE EN "L" 7" NEGRO	1	C/U
3540147	SOPORTE EN "L" 8" NEGRO	1	C/U
3540160	SOPORTE INTERIOR 30° 3"	1	C/U
3540161	SOPORTE INTERIOR 30° 2"	1	C/U
3540162	SOPORTE INTERIOR 45° 2"	1	C/U
3540163	SOPORTE INTERIOR 45° 3"	1	C/U
3540128	SOPORTE PARA ESCALONES	1	PAR
3540180	ANCLAJE DE POSTE 3"	1	C/U
3540181	ANCLAJE DE POSTE 4"	1	C/U
3540182	ANCLAJE DE POSTE 5"	1	C/U
3540183	ANCLAJE DE POSTE 6"	1	C/U

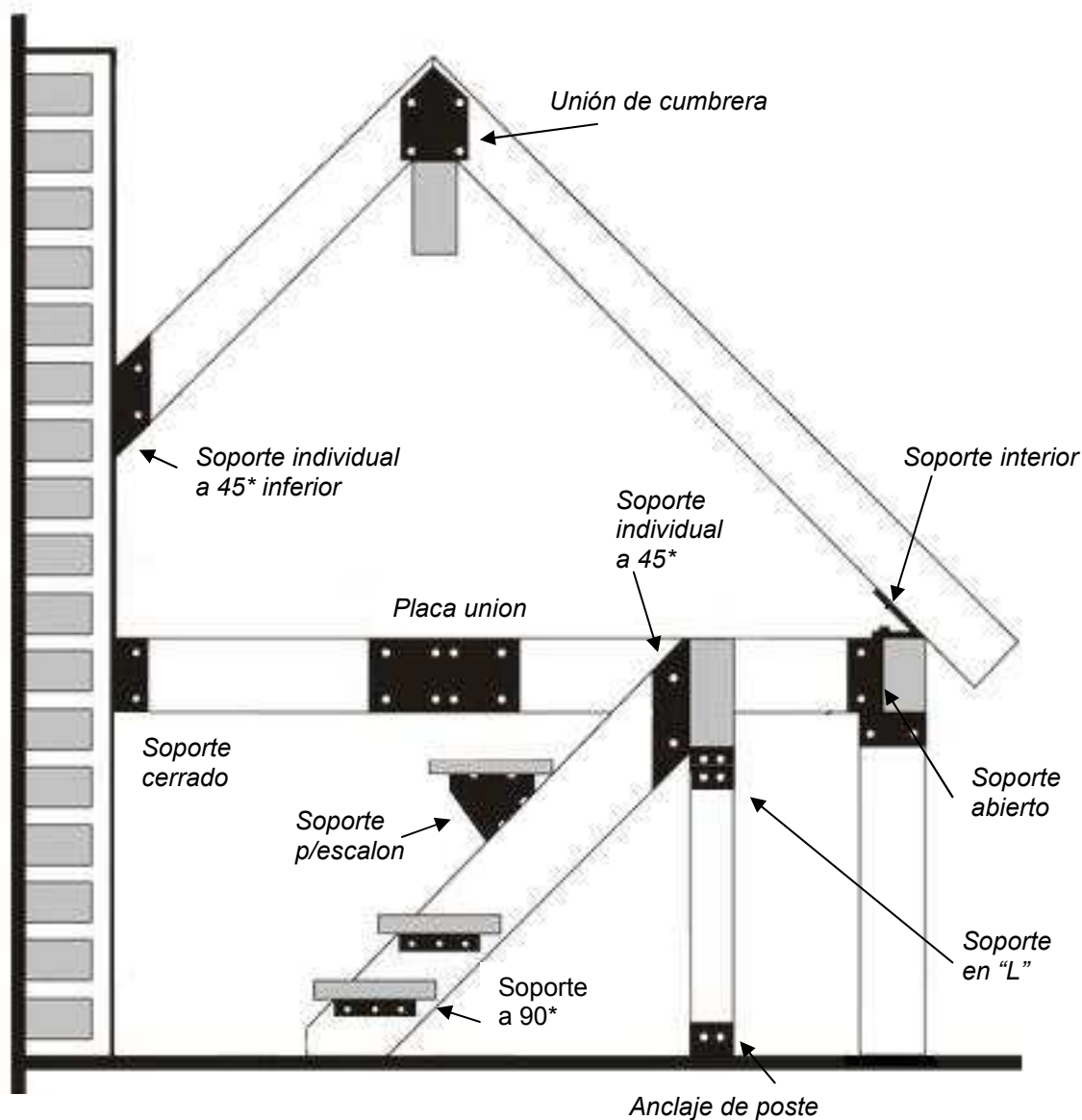

TORNILLOS HIERRO CINCADO AMARILLO CABEZA FRESADA

Código	Medida	Código	Medida	Código	Medida
4010106	14 X 10	4010201	20 X 13	4010248	23 X 20
4010107	14 X 13	4010202	20 X 15	4010249	23 X 25
4010108	14 X 15	4010203	20 X 17	4010250	23 X 30
4010109	14 X 17	4010204	20 X 20	4010251	23 X 35
4010110	14 X 20	4010205	20 X 25	4010252	23 X 40
4010111	15 X 10	4010206	20 X 30	4010253	23 X 45
4010112	15 X 13	4010207	20 X 35	4010254	23 X 50
4010113	15 X 15	4010208	20 X 40	4010255	23 X 55
4010114	15 X 17	4010209	20 X 45	4010256	23 X 60
4010115	15 X 20	4010210	20 X 50	4010257	23 X 65
4010116	15 X 25	4010211	20 X 55	4010258	23 X 70
4010117	15 X 30	4010212	20 X 60	4010259	23 X 75
4010118	16 X 10	4010213	20 X 65	4010260	23 X 80
4010119	16 X 13	4010214	20 X 70	4010261	23 X 90
4010120	16 X 15	4010215	20 X 75	4010262	23 X 100
4010121	16 X 17	4010216	21 X 15	4010263	24 X 25
4010122	16 X 20	4010217	21 X 17	4010264	24 X 30
4010123	16 X 25	4010218	21 X 20	4010265	24 X 35
4010124	16 X 30	4010219	21 X 25	4010266	24 X 40
4010125	17 X 10	4010220	21 X 30	4010267	24 X 45
4010126	17 X 13	4010221	21 X 35	4010268	24 X 50
4010127	17 X 15	4010222	21 X 40	4010269	24 X 55
4010128	17 X 17	4010223	21 X 45	4010270	24 X 60
4010129	17 X 20	4010224	21 X 50	4010271	24 X 65
4010130	17 X 25	4010225	21 X 55	4010272	24 X 70
4010131	17 X 30	4010226	21 X 60	4010273	24 X 75
4010132	17 X 35	4010227	21 X 65	4010274	24 X 80
4010133	18 X 10	4010228	21 X 70	4010275	24 X 90
4010134	18 X 13	4010229	21 X 75	4010276	24 X 100
4010135	18 X 15	4010230	21 X 80		
4010136	18 X 17	4010231	22X 15		
4010137	18 X 20	4010232	22 X 17		
4010138	18 X 25	4010233	22 X 20		
4010139	18 X 30	4010234	22 X 25		
4010140	18 X 35	4010235	22 X 30		
4010141	18 X 40	4010236	22 X 35		
4010142	18 X 45	4010237	22 X 40		
4010143	19 X 13	4010238	22 X 45		
4010144	19 X 15	4010239	22 X 50		
4010145	19 X 17	4010240	22 X 55		
4010146	19 X 20	4010241	22 X 60		
4010147	19 X 25	4010242	22 X 65		
4010148	19 X 30	4010243	22 X 70		
4010149	19 X 35	4010244	22 X 75		
4010150	19 X 40	4010245	22 X 80		
4010151	19 X 45	4010246	22 X 90		
4010152	19 X 50	4010247	22 X 100		



**Unidad de Medida:
Gruesa=144**

**Envasados en
cajas de una
gruesa (144 uds)**

TORNILLOS DE HIERRO BRONCEADO CAB.FRESADA

Código	Medida	Código	Medida	Código	Medida
4011006	14X10	4011051	19X45		
4011007	14X13	4011052	19X50		
4011008	14X15	4011053	20X13		
4011009	14X17	4011054	20X15		
4011010	14X20	4011055	20X17		
4011011	15X10	4011056	20X20		
4011012	15X13	4011057	20X25		
4011013	15X15	4011058	20X30		
4011014	15X17	4011059	20X35		
4011015	15X20	4011060	20X40		
4011016	15X25	4011061	20X45		
4011017	15X30	4011062	20X50		
4011018	16X10	4011063	20X55		
4011019	16X13	4011064	20X60		
4011020	16X15	4011065	20X65		
4011021	16X17	4011066	20X70		
4011022	16X20	4011067	20X75		
4011023	16X25	4011068	21X15		
4011024	16X30	4011069	21X17		
4011025	17X10	4011070	21X20		
4011026	17X13	4011071	21X25		
4011027	17X15	4011072	21X30		
4011028	17X17	4011073	21X35		
4011029	17X20	4011074	21X40		
4011030	17X25	4011075	21X45		
4011031	17X30	4011076	21X50		
4011032	17X35	4011077	21X55		
4011033	18X10	4011078	21X60		
4011034	18X13	4011079	21X65		
4011035	18X15	4011080	21X70		
4011036	18X17	4011081	21X75		
4011037	18X20	4011082	21X80		
4011038	18X25	4011084	22X40		
4011039	18X30	4011086	22X50		
4011040	18X35	4011088	22X60		
4011041	18X40				
4011042	18X45				
4011043	19X13				
4011044	19X15				
4011045	19X17				
4011046	19X20				
4011047	19X25				
4011048	19X30				
4011049	19X35				
4011050	19X40				



**Unidad de Medida:
Gruesa=144**

**Envasados en
cajas de una
gruesa (144 uds)**

TORNILLOS DE BRONCE CABEZA FRESADA

Medida	Pulido	Platil	Medida	Pulido	Platil
14 X 10	4010301	4010401	20 X 55	4010346	4010446
14 X 13	4010302	4010402	20 X 60	4010347	4010447
14 X 15	4010303	4010403	20 X 70	4010348	4010448
14 X 17	4010304	4010404	21 X 20	4010351	4010451
16 X 10	4010306	4010406	21 X 25	4010352	4010452
16 X 13	4010307	4010407	21 X 30	4010353	4010453
16 X 15	4010308	4010408	21 X 35	4010354	4010454
16 X 17	4010309	4010409	21 X 40	4010355	4010455
16 X 20	4010310	4010410	21 X 45	4010356	4010456
17 X 10	4010311	4010411	21 X 50	4010357	4010457
17 X 13	4010312	4010412	21 X 55	4010358	4010458
17 X 15	4010313	4010413	21 X 60	4010359	4010459
17 X 17	4010314	4010414	21 X 70	4010360	4010460
17 X 20	4010315	4010415	22 X 20	4010361	4010461
17 X 25	4010316	4010416	22 X 25	4010362	4010462
17 X 30	4010317	4010417	22 X 30	4010363	4010463
18 X 10	4010318	4010418	22 X 35	4010364	4010464
18 X 13	4010319	4010419	22 X 40	4010365	4010465
18 X 15	4010320	4010420	22 X 45	4010366	4010466
18 X 17	4010321	4010421	22 X 50	4010367	4010467
18 X 20	4010322	4010422	22 X 55	4010368	4010468
18 X 25	4010323	4010423	22 X 60	4010369	4010469
18 X 30	4010324	4010424	22 X 70	4010370	4010470
18 X 35	4010325	4010425			
18 X 40	4010326	4010426			
19 X 13	4010327	4010427			
19 X 15	4010328	4010428			
19 X 17	4010329	4010429			
19 X 20	4010330	4010430			
19 X 25	4010331	4010431			
19 X 30	4010332	4010432			
19 X 35	4010333	4010433			
19 X 40	4010334	4010434			
19 X 45	4010335	4010435			
19 X 50	4010336	4010436			
20 X 15	4010337	4010437			
20 X 17	4010338	4010438			
20 X 20	4010339	4010439			
20 X 25	4010340	4010440			
20 X 30	4010341	4010441			
20 X 35	4010342	4010442			
20 X 40	4010343	4010443			
20 X 45	4010344	4010444			
20 X 50	4010345	4010445			

Envasados en
cajas de una
gruesa (144 uds)



TORNILLOS DE BRONCE CABEZA GOTA DE SEBO

Medida	Pulido	Platil	Medida	Pulido	Platil
14 x 10	4010501	4010601	20 x 50	4010545	4010645
14 x 13	4010502	4010602	20 x 55	4010546	4010646
14 x 15	4010503	4010603	20 x 60	4010547	4010647
14 x 17	4010504	4010604	20 x 70	4010548	4010648
14 x 20	4010505	4010605	21 x 25	4010552	4010652
16 x 10	4010506	4010606	21 x 30	4010553	4010653
16 x 13	4010507	4010607	21 x 35	4010554	4010654
16 x 15	4010508	4010608	21 x 40	4010555	4010655
16 x 17	4010509	4010609	21 x 45	4010556	4010656
16 x 20	4010510	4010610	21 x 50	4010557	4010657
17 x 10	4010511	4010611	21 x 55	4010558	4010658
17 x 13	4010512	4010612	21 x 60	4010559	4010659
17 x 15	4010513	4010613	21 x 70	4010560	4010660
17 x 17	4010514	4010614	22 x 20	4010561	4010661
17 x 20	4010515	4010615	22 x 25	4010562	4010662
17 x 25	4010516	4010616	22 x 30	4010563	4010663
17 x 30	4010517	4010617	22 x 35	4010564	4010664
18 x 10	4010518	4010618	22 x 40	4010565	4010665
18 x 13	4010519	4010619	22 x 45	4010566	4010666
18 x 15	4010520	4010620	22 x 50	4010567	4010667
18 x 17	4010521	4010621	22 x 55	4010568	4010668
18 x 20	4010522	4010622	22 x 60	4010569	4010669
18 x 25	4010523	4010623	22 x 70	4010570	4010670
18 x 30	4010524	4010624			
18 x 35	4010525	4010625			
18 x 40	4010526	4010626			
19 x 13	4010527	4010627			
19 x 15	4010528	4010628			
19 x 17	4010529	4010629			
19 x 20	4010530	4010630			
19 x 25	4010531	4010631			
19 x 30	4010532	4010632			
19 x 35	4010533	4010633			
19 x 40	4010534	4010634			
19 x 45	4010535	4010635			
19 x 50	4010536	4010636			
20 x 15	4010537	4010637			
20 x 17	4010538	4010638			
20 x 20	4010539	4010639			
20 x 25	4010540	4010640			
20 x 30	4010541	4010641			
20 x 35	4010542	4010642			
20 x 40	4010543	4010643			
20 x 45	4010544	4010644			

**Unidad de Medida:
Gruesa=144**



**Envasados en
cajas de una
gruesa (144 uds)**

TORNILLOS PARKER					
Código	Medida	Código	Medida		Código Medida
PARKER CINCADOS					BRONCEADOS
4010701	4 X ¼	4010745	12 X 1"		4010803 4x3/8
4010702	4 X 5/16	4010746	12 X 1"1/4		4010804 4x1/2
4010703	4 X 3/8	4010747	12 X 1"1/2		4010805 4x5/8
4010704	4 X ½	4010748	12 X 2"		4010806 4x3/4
4010705	4 X 5/8	4010749	14 X 5/8		4010809 6x3/8
4010706	4 X ¾	4010750	14 X ¾		4010810 6x1/2
4010707	6 X ¼	4010751	14 X 7/8		4010811 6x5/8
4010708	6 X 5/16	4010752	14 X 1"		4010812 6x3/4
4010709	6 X 3/8	4010753	14 X 1"1/4		4010813 6x7/8
4010710	6 X ½	4010754	14 X 1"1/2		4010816 7x1/2
4010711	6 X 5/8	4010755	14 X 2"		4010817 7x5/8
4010712	6 X ¾				4010818 7x3/4
4010713	6 X 7/8				4010819 7x7/8
4010714	6 X 1"				4010820 7x1
4010715	7 X 3/8				
4010716	7 X ½				
4010717	7 X 5/8				
4010718	7 X ¾				
4010719	7 X 7/8				
4010720	7 X 1"				
4010721	7 X 1 ¼				
4010722	7 X 1"1/2				
4010723	8 X 3/8				
4010724	8 X ½				
4010725	8 X 5/8				
4010726	8 X ¾				
4010727	8 X 7/8				
4010728	8 X 1"				
4010729	8 X 1"1/4				
4010730	8 X 1"1/2				
4010731	8 X 2"				
4010732	10 X 3/8				
4010733	10 X ½				
4010734	10 X 5/8				
4010735	10 X ¾				
4010736	10 X 7/8				
4010737	10 X 1"				
4010738	10 X 1"1/4				
4010739	10 X 1"1/2				
4010740	10 X 2"				
4010741	12 X ½				
4010742	12 X 5/8				
4010743	12 X ¾				
4010744	12 X 7/8				



Envasados en cajas de 200 uds.

Unidad de Medida: Caja x 200.

DRYWALL		PHILLIPS		TIRAFONDOS CINCADOS	
Codigo	Medida	Codigo	Medida	Código	Descripción
9047401	6 X 5/8	9047504	3.0X12	4110101	3/16X1
9047402	6 X 3/4	9047505	3.0X15	4110102	3/16X1 1/4
9047403	6 X 1"	9047506	3.0X20	4110103	3/16X1 1/2
9047404	6 X 1 1/4"	9047507	3.0X25	4110104	3/16X1 3/4
9047405	6 X 1 1/2	9047511	3.5X15	4110105	3/16X2
9047406	6 X 1 5/8"	9047512	3.5X20	4110106	3/16X2 1/4
9047407	6 X 2"	9047513	3.5X25	4110107	3/16X2 1/2
9047408	6 X 2 1/4"	9047514	3.5X30	4110108	3/16X2 3/4
		9047515	3.5X35	4110109	3/16X3
		9047516	3.5X40	4110120	1/4X1
		9047520	4.0X15	4110121	1/4X1 1/4
		9047521	4.0X20	4110122	1/4X1 1/2
		9047522	4.0X25	4110123	1/4X1 3/4
		9047523	4.0X30	4110124	1/4X2
		9047524	4.0X35	4110125	1/4X2 1/4
		9047525	4.0X40	4110126	1/4X2 1/2
		9047526	4.0X45	4110127	1/4X2 3/4
		9047527	4.0X50	4110128	1/4X3
		9047528	4.0X60	4110130	1/4X3 1/2
		9047529	4.0X70	4110131	1/4X4
		9047530	4.5X30	4110140	5/16X1
		9047531	4.5X35	4110141	5/16X1 1/4
		9047532	4.5X40	4110142	5/16X1 1/2
		9047533	4.5X45	4110143	5/16X1 3/4
		9047534	4.5X50	4110144	5/16X2
		9047543	5.0X30	4110145	5/16X2 1/4
		9047543	5.0X35	4110146	5/16X2 1/2
		9047544	5.0X40	4110147	5/16X2 3/4
		9047545	5.0X45	4110148	5/16X3
		9047546	5.0X50	4110150	5/16X3 1/2
		9047547	5.0X60	4110151	5/16X4
		9047548	5.0X70	4110152	5/16X4 1/2
				4110153	5/16X5
				4110160	3/8X1 1/2
				4110161	3/8X1 3/4
				4110162	3/8X2
				4110163	3/8X2 1/4
				4110164	3/8X2 1/2
				4110165	3/8X2 3/4
				4110166	3/8X3
				4110167	3/8X3 1/4
				4110168	3/8X3 1/2
				4110169	3/8X4
				4110170	3/8X4 1/2
				4110171	3/8X5



Negros

Unidad de Medida:
Mil

Envasados en
cajas de 200 uds.



Envasados
en cajas de
100 uds.

Unidad de
Medida:
Cien

Cincado amarillo



Unidad de
Medida:
Mil

U.M.: CIEN

TARUGOS COMUNES NYLON

Código	Descripción	X Caja	U.M.
4170101	C-4 MM X200	1	PACK
4170102	C-5 MM X 200	1	PACK
4170103	C-6 MM X 100	1	PACK
4170104	C-8 MM X 100	1	PACK
4170105	C-10 MM X 50	1	PACK
4170106	C-12 MM X 25	1	PACK
4170107	C-14 MM X 20	1	PACK
4170201	C-5 MM BOLSA X 1000	1	PACK
4170202	C-6 MM BOLSA X 2000	1	PACK
4170203	C-8 MM BOLSA X 1000	1	PACK
4170204	C-10 MM BOLSA X 500	1	PACK
4170205	C-12 MM BOLSA X 250	1	PACK
4170206	C-14 MM BOLSA X 200	1	PACK

CON ARANDELA

4171101	C-5 MM X 200	1	PACK
4171102	C-6 MM X 100	1	PACK
4171103	C-8 MM X 100	1	PACK
4171104	C-10 MM X 50	1	PACK
4171105	C-12 MM X 25	1	PACK
4171106	C-14 MM X 20	1	PACK



TARUGOS PARA LADRILLO HUECO/YESO

Código	Descripción	X Caja	U.M.
TARUGOS MULTIUSO			
4171501	MULTIUSO 6MM X 100	1	PACK
4171502	MULTIUSO 8MM X 50	1	PACK
4171503	MULTIUSO 10 MM X 25	1	PACK
4171505	MULTIUSO 6MM C/ARANDELA X 100	1	PACK
4171506	MULTIUSO 8MM C/ARANDELA X 50	1	PACK
4171507	MULTIUSO 10 MM C/ARAND.X25	1	PACK

TARUGOS PARA YESO-DURLOK

4173001	HD-10 (PARA LADRILLO HUECO)X50	1	PACK
4173002	HD-20 (PARA LADRILLO HUECO)X50	1	PACK
4172001	C-DUR (PARA YESO)X25	1	PACK

TARUGOS SX

4030901	SX5 X 100	1	PACK
4030902	SX6 X 100	1	PACK
4030903	SX8 X 100	1	PACK
4030904	SX10 X 50	1	PACK

TARUGOS FU

4030940	FU6 X35 X 100	1	PACK
4030941	FU8 X50 X 50	1	PACK
4030942	FU10X60 X25	1	PACK



HD 10/20

C-DUR



TARUGOS CON TIRAFONDO

Código	Descripción	X Caja	U.M.
4030802	FUR 10 x 80	50	C/U
4030804	FUR 10 x 100	50	C/U
4030806	FUR 10 x 135	50	C/U
4030820	FUR 8 X 80	50	C/U
4030821	FUR 8 X 100	50	C/U





TACO FUR

BROCAS METALICAS

Código	Descripción	X Caja	U.M.
4030330	BROCA IM 3/16	100	C/U
4030351	BROCA IM ¼	100	C/U
4030352	BROCA IM 5/16	100	C/U
4030353	BROCA IM 3/8	50	C/U
4030354	BROCA IM ½	50	C/U
4030355	BROCA IM 5/8	25	C/U
4030356	BROCA IM 3/4	25	C/U



PITONES ABIERTOS						
Código	Medida	U.med		Código	Medida	U.med
4020101	15 X 25	x300		4020138	22 X 90	x100
4020102	15 X 30	x200		4020139	22 X 100	x100
4020103	15 X 35	x200		4020140	22 X 110	x100
4020104	16 X 25	x200		4020141	22 X 120	x100
4020105	16 X 30	x200		4020142	23 X 60	x100
4020106	16 X 35	x200		4020143	23 X 70	x100
4020107	16 X 40	x200		4020144	23 X 80	x100
4020108	16 X 50	x200		4020145	23 X 90	x100
4020109	17 X 35	x200		4020146	23 X 100	x100
4020110	17 X 40	x200		4020147	23 X 120	x100
4020111	17 X 50	x200	4020148	24 X 70	x50	
4020112	17 X 60	x100	4020149	24 X 80	x50	
4020113	18 X 40	x100		4020150	24 X 90	x50
4020114	18 X 50	x100		4020151	24 X 100	x50
4020115	18 X 60	x100		4020152	24 X 120	x50
4020116	18 X 80	x100		4020153	25 X 70	x50
4020117	18 X 90	x100		4020154	25 X 80	x50
4020118	19 X 50	x100		4020155	25 X 90	x50
4020119	19 X 60	x100		4020156	25 X 100	x50
4020120	19 X 70	x100		4020157	25 X 110	x50
4020122	19 X 90	x100		4020158	25 X 130	x50
4020124	20 X 50	x100		4020159	26 X 80	x25
4020125	20 X 60	x100		4020160	26 X 90	x25
4020126	20 X 70	x100		4020161	26 X 110	x25
4020127	20 X 80	x100		4020162	26 X 120	x25
4020128	20 X 90	x100		4020163	26 X 130	x25
4020130	21 X 60	x100		4020164	26 X 140	x25
4020131	21 X 70	x100		4020165	26 X 150	x25
4020132	21 X 80	x100		4020166	27 X 90	x25
4020134	21 X 100	x100		4020167	27 X 120	x25
4020135	21 X 110	x100		4020168	27 X 140	x25
4020136	22 X 70	x100		4020169	27 X 160	x25
4020137	22 X 80	x100				

PITON PERCHA						
Código	Medida	U.med		Código	Medida	U.med
4020182	19X130	x100		4020183	19X150	100

PITONES CERRADOS						
Código	Medida	U.med		Código	Medida	U.med
4020201	14 X 20	x300		4020236	23 X 60	x100
4020202	15 X 25	x300		4020237	23 X 70	x100
4020203	15 X 30	x200		4020238	23 X 80	x100
4020204	15 X 35	x200		4020239	23 X 90	x100
4020205	16 X 25	x200		4020240	23 X 100	x100
4020206	16 X 30	x200		4020241	23 X 120	x100
4020207	16 X 35	x200		4020242	24 X 70	x50

4020208	16 X 40	x200
4020209	17 X 35	x200
4020210	17 X 40	x200
4020211	17 X 50	x200
4020213	18 X 40	x100
4020214	18 X 50	x100
4020216	19 X 45	x100
4020217	19 X 50	x100
4020218	19 X 60	x100
4020219	19 X 70	x100
4020220	20 X 40	x100
4020221	20 X 50	x100
4020222	20 X 60	x100
4020223	20 X 70	x100
4020225	21 X 60	x100
4020226	21 X 70	x100
4020227	21 X 80	x100
4020228	21 X 90	x100
4020229	21 X 100	x100
4020230	22 X 70	x100
4020231	22 X 80	x100
4020232	22 X 90	x100
4020233	22 X 100	x100

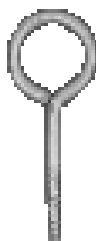

4020243	24 X 80	x50
4020244	24 X 90	x50
4020245	24 X 100	x50
4020246	24 X 120	x50
4020247	25 X 70	x50
4020248	25 X 80	x50
4020249	25 X 90	x50
4020250	25 X 100	x50
4020251	25 X 110	x50
4020252	25 X 130	x50
4020253	26 X 80	x25
4020254	26 X 90	x25
4020255	26 X 110	x25
4020256	26 X 120	x25
4020257	26 X 130	x25
4020258	26 X 140	x25
4020259	26 X 150	x25
4020260	27 X 90	x25
4020261	27 X 120	x25
4020262	27 X 140	x25
4020263	27 X 160	x25

PITONES ESCUADRA

Código	Medida	U.med
4020301	15 X 25	x300
4020302	16 X 30	x200
4020303	17 X 35	x200
4020304	17 X 40	x200
4020305	18 X 40	x100
4020307	19 X 50	x100
4020309	20 X 50	x100
4020310	20 X 60	x100
4020311	21 X 40	x100
4020312	21 X 50	x100
4020313	21 X 60	x100
4020314	21 X 70	x100
4020317	22 X 70	x100
4020318	22 X 80	x100
4020319	23 X 60	x100



Código	Medida	U.med
4020320	23 X 70	x100
4020321	23 X 80	x100
4020322	23 X 90	x100
4020325	24 X 90	x50
4020326	24 X 100	x50
4020329	25 X 100	x50
4020330	25 X 110	x50
4020334	26 X 110	x25
4020335	26 X 120	x25
4020337	27 X 120	x25
4020338	27 X 140	x25

PITONES CON ROSCA "W"

Código	Medida	U.med
ABIERTOS		
4020925	3.17 X 40	X50
4020926	3.17 X 50	X50
4020927	3.97 X 50	X50
4020928	3.97 X 60	X50
4020929	4.76 X 60	X50
4020930	4.76 X 70	X50
4020931	6.35 X 80	X25
4020932	6.35 X 90	X25
4020933	7.94 X 100	X25
4020934	7.94 X 110	X25



Código	Medida	U.med
ESCUADRA		
4020935	3.17 x 40	X25
4020936	3.97 x 50	X50
4020937	4.76 x 60	X50
4020940	4.76 x 80	X50
4020938	6.35 x 80	X25
4020941	6.35 x 100	X25
4020942	6.35 x 140	X25
4020939	7.94 x 100	X25
4020943	7.94 x 120	X25
4020944	7.94 x 140	X25

CERRADOS SIN SOLDAR	U.med
4020901	3.17 X 40 X50
4020902	3.17 X 50 X50
4020903	3.97 X 50 X50
4020904	3.97 X 60 X50
4020905	4.76 X 60 X50
4020906	4.76 X 70 X50

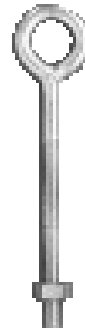
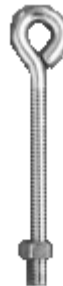

SOLDADOS	U.med
4020911	4.76 X 70 X25
4020912	6.35 X 70 X50
4020913	6.35 X 80 X25
4020914	6.35 X 90 X25
4020915	6.35 X 100 X25
4020916	7.94 X 80 X25
4020917	7.94 X 90 X25
4020918	7.94 X 100 X25
4020919	7.94 X 110 X25

OJO CHICO	U.med
4020907	6.35 X 75 X50
4020908	6.35 X 90 X25
4020909	7.94 X 105 X25
4020910	7.94 X 125 X25



CERRADOS CON ARGOLLA	U.med
4021201	4.76 X 70 X25
4021205	6.35 X 90 X25
4021210	7.94 X 120 X25

GANCHO BASTON	U.med
4021701	6.35 X 50 X25
4021702	6.35 X 60 X25
4021703	6.35 X 70 X25
4021704	6.35 X 80 X25
4021705	6.35 X 90 X25
4021706	6.35 X 100 X25



CERRADO SOLDADO Y CEMENT.	U.med
4020950	6.35X100 X25
4020951	7.94 X 70 X25
4020952	7.97 X 110 X25
4020953	7.94 X 120 X25
4020954	9.52 X 95 X25
4020955	9.52 X 110 X25

PITONES BRONCEADOS CON TOPE

Código	Medida	U.med
ABIERTOS		
4021006	16X35	X200
4021007	17X40	X200
4021008	18X45	X100
4021009	19X50	X100
4021010	21X60	X50
4021011	21X70	X50
4021012	23X80	X25



Código	Medida	U.med
ESCUADRA		
4021013	16X35	X200
4021014	17X40	X200
4021021	18X45	X100
4021022	19X50	X100
4021023	21X60	X50
4021024	21X70	X50

GANCHOS CONTRA VIENTO

Código	Medida	U.med	Código	Medida	U.med
4020401	18 X 30	X25	4020416	24 X 160	X25
4020402	18 X 40	X25	4020417	24 X 180	X25
4020403	19 X 50	X25	4020418	25 X 120	X25
4020404	19 X 60	X25	4020420	25 X 170	X25
4020405	20 X 70	X25	4020421	25 X 200	X25
4020406	20 X 80	X10	4020422	26 X 130	X10
4020407	21 X 90	X10	4020423	26 X 160	X10
4020408	21 X 100	X10	4020425	26 X 210	X10
4020409	22 X 110	X10	4020426	27 X 140	X10
4020410	22 X 120	X10	4020427	27 X 170	X10
4020411	23 X 130	X10	4020428	27 X 190	X10
4020413	24 X 90	X25	4020429	27 X 210	X10
4020414	24 X 110	X25			
4020415	24 X 140	X25			

CON PITON DE ANCLAJE

4020440	5 X 70	X25	4020443	5 X 140	X25
4020441	5 X 90	X25	4020444	6 X 90	X25
4020442	5 X 110	X25	4020445	6 X 160	X25

PITONES DE ANCLAJE CON TOPE

Medida	Abierto	Cerrado	Escuadra	U.med
4	4020500	40205041	40205081	X100
5	4020501	4020505	4020509	X50
6	4020502	4020506	4020510	X50
8	4020503	4020507	4020511	X50
10	4020504	4020508	4020512	X25
12	40205040	40205080	4020517	X20



TENSORES CINCADOS

Código	Medida	xcaja	U.med
4021110	50 MM	1	X10
4021111	60 MM	1	X10
4021112	80 MM	1	X10
4021113	100 MM	1	X10



GANCHOS USOS VARIOS

Código	Descripción	U.med
4021501	GANCHO HORQUILLA H1	X6
4021502	GANCHO BICICLETA B1-6 MM	X12
4021503	GANCHO BICICLETA B2-8 MM	X6
4021504	GANCHO TECHO T1	X6
4021505	GANCHO MANGUERA M1	X6
4021506	GANCHO ESCALERA E1 CORTO	X12
4021507	GANCHO ESCALERA E2 LARGO	X12

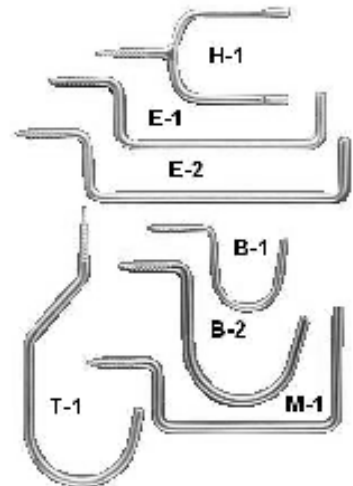

GANCHOS HAMACA		U.med
4021508	PH1 ABIERTO CON PITON N.12	X6
4021509	PH1A CERRADO CON PITON N.12	X6
4021510	PH2 ABIERTO CON BASE 4 AGUJ.	X6
4021511	PH2A CERRADO CON BASE 4 AGUJ.	X6

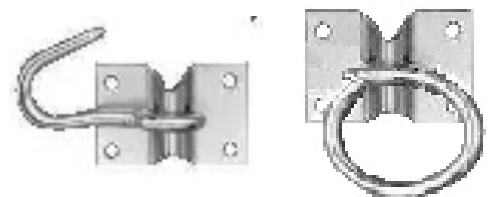

CLAVOS ESCUADRA

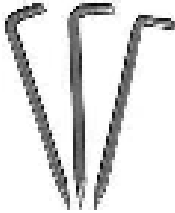
Código	Medida	U.med		Código	Medida	U.med
CINCADOS				ACERO		
4020609	3 X 30	x100		4020705	3 X 30	x100
4020612	3 X 40	x100		4020706	3 X 40	x100
4020617	3.5 X 50	x100		4020707	3.5 X 50	x100
4020623	3.5 X 60	x100		4020708	3.5 X 60	x100
4020628	4 X 70	x50		4020709	4 X 70	x50
4020634	4 X 80	x50		4020710	4 X 80	x50
4020639	4.5 X 90	x50		4020711	4.5 X 90	x50

CLAVOS CABEZA PERDIDA

Código	Medida	xcaja		Código	Medida	xcaja
4050201	6 X 12	1		4050216	10 X 35	1
4050203	6 X 16	1		4050217	10 X 40	1
4050205	7 X 16	1		4050220	12 X 30	1
4050207	7 X 20	1		4050221	12 X 35	1
4050209	8 X 20	1		4050222	12 X 40	1
4050210	8 X 25	1		4050237	12 X 50	1
4050235	8 X 30	1		4050225	14 X 40	1
4050236	9 X 20	1		4050226	14 X 50	1
4050211	9 X 25	1		4050227	15 X 50	1
4050212	9 X 30	1		4050228	16 X 63	1
4050214	10 X 25	1		4050229	17 X 75	1
4050215	10 X 30	1				

Paq.de 1 kgmo.

CLAVOS CABEZA CHATA

Código	Medida	xcaja		Código	Medida	xcaja
4050101	6 X 12	1		4050116	10 X 35	1
4050103	6 X 16	1		4050117	10 X 40	1
4050105	7 X 16	1		4050121	12 X 35	1
4050107	7 X 20	1		4050123	12 X 50	1
4050109	8 X 20	1		4050124	12 X 40	1
4050110	8 X 25	1		4050126	14 X 40	1
4050135	8 X 30	1		4050128	14 X 50	1
4050136	9 X 20	1		4050129	15 X 50	1
4050111	9 X 25	1		4050130	16 X 63	1
4050112	9 X 30	1		4050131	17 X 75	1
4050114	10 X 25	1				
4050115	10 X 30	1				

CLAVOS CABEZA PIZARRA

Código	Medida	xcaja		Código	Medida	xcaja
4050501	16 X 20	1		4050504	16 X 35	1
4050502	16 X 25	1		4050505	16 X 40	1
4050503	16 X 30	1				

CLAVOS PUNTA PARIS



Código	Medida	xcaja		Código	Medida	xcaja
4050301	25 MM.	1		4050305	76 MM.	1
4050302	38 MM.	1		4050306	89 MM.	1
4050303	51 MM.	1		4050307	101 MM.	1
4050304	63 MM.	1		4050308	127 MM.	1
				4050309	150 MM.	1

CLAVOS ESPIRALADOS

Código	Medida	xcaja		Código	Medida	xcaja
4050401	25 MM.	1		4050405	76 MM.	1
4050402	38 MM.	1		4050406	101 MM.	1
4050403	51 MM.	1		4050407	127 MM.	1
4050404	63 MM.	1		4050408	150 MM.	1

Paq.de 1 kgmo.

CLAVOS DE ACERO

Código	Medida	U.med		Código	Medida	U.med
CABEZA PERDIDA				CON CABEZA-2.5 MM		
4030420	CCP 30	x100		4030409	CP225	x100
4030421	CCP35	x100		4030410	CP230	x100
4030422	CCP40	x100		4030411	CP235	x100
4030423	CCP45	x100		4030412	CP240	x100
CON CABEZA ECO				4030413	CP250	x100
4020715	1.7 X 20	x400		4030414	CP260	x100
4020716	1.7 X 25	x400		4030415	CP270	x100
4020718	2 X 25	x200		CON CABEZA-3.2 MM		
4020719	2 X 30	x200		4030401	CP25	x100
4020720	2 X 40	x200		4030402	CP30	x100
4020730	2.5 X 25	x200		4030403	CP35	x100
4020732	2.5 X 30	x200		4030404	CP40	x100
4020733	2.5 X 40	x200		4030405	CP50	x100
4020721	3 X 30	x100		4030406	CP60	x100
4020722	3 X 40	x100	4030407	CP70	x100	
4020723	3 X 50	x100	4030408	CP80	x100	
4020724	3 X 60	x100				

CLAVOS "ESTRIBO" BRONCEADOS

Código	Medida	xcaja		Código	Medida	xcaja
2190901	8 X 10	500 GRS.		2190905	12 X 14	500 GRS.
2190902	10 X 12	500 GRS.		2190906	12 X 16	500 GRS.
2190903	10 X 14	500 GRS.		2190907	12 X 18	500 GRS.
2190920	10 X 25	500 GRS.		2190908	12 X 20	500 GRS.
2190904	12 X 12	500 GRS.				

Paq.de 1/2 kgmo.

GRAMPAS COBREADAS

Código	Medida	xcaja
4050605	Num.9	1



Paq.de 1 kgmo.

COLA SINTETICA



Código	Descripción	X Caja	U.M.
A-20 USO GENERAL			
6010001	A-20 X 200 GRS CON PICO	12	C/U
6010002	A-20 X 800 GRS CON PICO	12	C/U
6010100	A-20 X 125 GRS.	24	C/U
6010101	A-20 X 250 GRS.	24	C/U
6010102	A-20 X 500 GRS.	24	C/U
6010103	A-20 X 1 KG.	16	C/U
6010104	A-20 X 6 KG.	4	C/U
6010105	A-20 X 24 KG.	1	C/U
X-36 LINEA PESADA			
6010114	X-36 X 1 KG	12	C/U
6010115	X-36 X 6 KG	4	C/U
6010130	X-36 X 22 KG	1	C/U
P-60 PARA PARQUETS			
6010701	P-60 X 1 KGM.	12	C/U
6010702	P-60 X 5 KGM.	1	C/U
6010711	P-61 IMPRIMACION X 1 LT	12	C/U
6010712	P-61 IMPRIMACION X 5 LT	1	C/U



COLA CALIENTE

Código	Descripción	X Caja	U.M.
6010506	FR 1 KG.	12	C/U
6010507	FR 20 KG.	1	C/U



RESINA UREICA

Código	Descripción	X Caja	U.M.
6010301	U-1065 X 6 KG.	4	C/U
6010302	U-1065 X 26 KG.	1	C/U
6010601	CATALIZADOR C.A. 1 KG.	12	C/U



ASISTENTE PARA CEMENTO

Código	Descripción	X Caja	U.M.
6010401	1 LT.	16	C/U
6010403	4 LT.	4	C/U
6010404	18 LT.	1	C/U



CEMENTO DE CONTACTO

Código	Descripción	X Caja	U.M.
6010200	A101 X 50 CC (POMO)	24	C/U
6010201	A101 X 125 CC	24	C/U
6010202	A101 X 250 CC	24	C/U
6010203	A101 X 500 CC	24	C/U
6010204	A101 X 1 LT.	18	C/U
6010205	A101 X 4 LT.	4	C/U
6010206	A101 X 10 LT.	1	C/U
6010207	A101 X 18 LT.	1	C/U



SELLADOR DE SILICONAS

Código	Descripción	X Caja	U.M.
6010750	POMO X 50 GRS.	24	C/U
6010751	CARTUCHO X 300 GRS TRASLUCIDA	12	C/U
6010752	CARTUCHO X 300 GRS BLANCA	12	C/U
6010753	CARTUCHO X 300 GRS NEGRA	12	C/U
6010755	CARTUCHO X 300 GRS NEUTRA	12	C/U

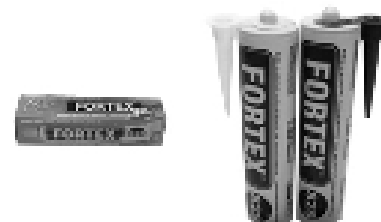
FORTEX



LINEA NITRO

Código	Descripción	X Caja	U.M.
SELLADORES			
5550111	SELLADOR X 0.9 LTS	1	C/U
5550113	SELLADOR X 3.6 LTS	1	C/U
55501131	SELLADOR X 20 LTS	1	C/U
55501160	ENGROSADOR X 3.6 LTS	1	C/U
55501161	ENGROSADOR X 20 LTS	1	C/U
LACAS TRANSPARENTES			
5550118	BRILLANTE X 0.9 LTS	1	C/U
5550120	BRILLANTE X 3.6 LTS	1	C/U
5550121	SEMI MATE X 0.9 LTS	1	C/U
5550122	SEMI MATE X 3.6 LTS	1	C/U
5550125	MATE X 0.9 LTS	1	C/U
5550126	MATE X 3.6 LTS	1	C/U



LINEA POLIURETANICA

Código	Descripción	X Caja	U.M.
KIT P.U. TRANSPARENTE			
5550001	ACABADO BRILLANTE X 1.35 LTS	1	C/U
5550002	ACABADO SEMI MATE X 1.35 LTS	1	C/U
5550003	ACABADO MATE X 1.35 LTS	1	C/U
5550004	ACABADO BRILLANTE X 5.40 LTS	1	C/U
5550005	ACABADO SEMI MATE X 5.40 LTS	1	C/U
5550006	ACABADO MATE X 5.40 LTS	1	C/U
5550101	FONDO X 1.35 LTS	1	C/U
5550102	FONDO X 5.40 LTS	1	C/U
KIT P.U. BLANCO			
5550010	ACABADO BRILLANTE X 1.35 LTS	1	C/U
5550011	ACABADO SEMI MATE X 1.35 LTS	1	C/U
5550012	ACABADO MATE X 1.35 LTS	1	C/U
5550013	ACABADO BRILLANTE X 5.40 LTS	1	C/U
5550014	ACABADO SEMI MATE X 5.40 LTS	1	C/U
5550015	ACABADO MATE X 5.40 LTS	1	C/U
5550100	FONDO X 1.35 LTS	1	C/U
5550099	FONDO X 5.40 LTS	1	C/U
LINEA MONOCOMPONENTE			
5550103	UNIPOL BRILLANTE X 0.9 LTS	1	C/U
5550104	UNIPOL BRILLANTE X 3.6 LTS	1	C/U
5550105	UNIPOL SEMIMATE X 0.9 LTS	1	C/U
5550106	UNIPOL SEMIMATE X 3.6 LTS	1	C/U



BARNICES-IMPREGNANTES

Código	Descripción	X Caja	U.M.
5550107	BARNIZ PINCEL X 0.9 LTS	1	C/U
5550108	BARNIZ PINCEL X 3.6 LTS	1	C/U
5550109	BARNIZ MARINO X 0.9 LTS	1	C/U
5550110	BARNIZ MARINO X 3.6 LTS	1	C/U
5550301	IMPREGNANTE P/EXTERIOR X 0.9 L	1	C/U
5550302	IMPREGNANTE P/EXTERIOR X 3.6 L	1	C/U



DILUYENTES Y THINNERS

Código	Descripción	X Caja	U.M.
5550214	DILUYENTE POLIURETANO X 1.00 LT	1	C/U
5550215	DILUYENTE POLIURETANO X 5.00 LT	1	C/U
5550212	THINNER ESPECIAL X 1.00 LTS	1	C/U
5550213	THINNER ESPECIAL X 5.00 LTS	1	C/U
5550211	THINNER ESPECIAL X 20 LTS	1	C/U



TINTAS PARA MADERA

Código	Descripción	X Caja	U.M.
5550510	CAOBA	12	C/U
5550507	CEDRO	12	C/U
5550511	WENGUE	12	C/U
5550509	NOGAL	12	C/U
5550508	ROBLE CLARO	12	C/U

OBS: En frascos de 60 cc.



MASILLAS PARA MADERA

Código	Descripción	X Caja	U.M.
5550501	NATURAL	12	C/U
5550502	ROBLE	12	C/U
5550503	NOGAL	12	C/U
5550504	CEDRO	12	C/U
5550505	CAOBA	12	C/U
5550506	WENGUE	12	C/U

OBS: En frascos de 250 grs.



TINTAS PARA MADERA

Código	Descripción	X Caja	U.M.
5800160	CAOBA	12	C/U
5800161	CEDRO	12	C/U
58001610	VIRARO	12	C/U
58001611	NOGAL	12	C/U
58001612	ROBLE CLARO	12	C/U
58001613	ROBLE OSCURO	12	C/U
58001614	LAPACHO	12	C/U
58001615	PETIRIBI	12	C/U
58001616	ALGARROBO	12	C/U

OBS: En frascos de 60 cc.



TINTAS CUBRE RAYAS

Código	Descripción	X Caja	U.M.
5800104	RAYONEX CLARO	12	C/U
5800105	RAYONEX OSCURO	12	C/U
5800106	RAYONEX MEDIO	12	C/U

OBS: En frascos de 125 mm



MASILLAS PARA MADERA

Código	Descripción	X Caja	U.M.
5800150	CAOBA	12	C/U
58001500	CEDRO	12	C/U
58001501	VIRARO	12	C/U
580015010	ALGARROBO	12	C/U
58001502	NOGAL	12	C/U
58001503	ROBLE CLARO	12	C/U
58001504	ROBLE OSCURO	12	C/U
58001505	LAPACHO	12	C/U
58001506	HAYA	12	C/U
58001507	HAYA NATURAL	12	C/U
58001508	PINO	12	C/U
58001509	PETIRIBI	12	C/U

OBS: En potes de 300 grs.



PROTECTOR DE METALES

Código	Descripción	X Caja	U.M.
5800101	PROTEGEBRON X125 CC	12	C/U
5800102	PROTEGEBRON EXTERIOR X125 CC	12	C/U



LUSTRA METALES

Código	Descripción	X Caja	U.M.
5800109	BRONCE BRILL POMO X 100 GR	12	C/U
5800110	BRONCE BRILL X 225 CC	12	C/U
5800112	BRONCE BRILL X 500 CC	12	C/U
5800115	CROMO BRILL X 130 CC	12	C/U
5800134	CROMO BRILL POMO X 100 GR	12	C/U
5800120	PLATA BRILL X 130 CC	12	C/U
5800140	ACEROX X 225 CC	12	C/U
5800141	ACEROX X 500 CC	12	C/U

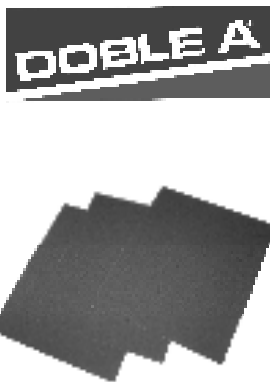

HOJAS DE LIJA						
Codigo	Medida	xcaja		Codigo	Medida	xcaja
NO PAST				RUBI		
6060101	500	100		6060201	220	100
6060102	400	100		6060202	180	100
6060103	360	100		6060203	150	100
6060104	320	100		6060204	120	100
6060105	280	100		6060205	100	100
6060106	240	100		6060206	80	100
6060107	220	100		6060207	60	100
6060108	180	100		6060208	50	100
6060109	150	100		6060209	40	100
6060110	120	100				
6060111	100	100				
6060112	80	100				

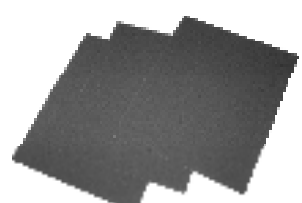
LIJA AL AGUA						
6060301	60	100		6060310	320	100
6060302	80	100		6060311	360	100
6060303	100	100		6060312	400	100
6060304	120	100		6060313	500	100
6060305	150	100		6060314	600	100
6060306	180	100		6060315	1000	100
6060308	240	100		6060316	1200	100
6060309	280	100		6060317	1500	100

ROLLOS DE LIJA ANCHO 150 MM							
150MM	36	40	50	60	80	100	120
PAPEL	6060507	6060506	6060505	6060504	6060503	6060502	6060501
TELA	6060707	6060706	6060705	6060704	6060703	6060702	6060701
610 MM	36	40	50	60	80	100	120
PAPEL	6060607	6060606	6060605	6060604	6060603	6060602	6060601

BANDAS PARA POLEA EXPANSIBLE						
	40	50	60	80	100	
50X242	6060810	6060808	6060806	6060804	6060802	
50X318	6060820	6060818	6060816	6060814	6060812	
50X478	6060830	6060828	6060826	6060824	6060822	

BANDAS PARA MAQUINA PORTATIL						
	40	50	60	80	100	120
64X410	6060906	6060905	6060904	6060903	6060902	6060901
75X457	6061014	6061013	6061012	6061011	6061010	6061009
75X533	6061030	6061029	6061028	6061027	6061026	6061025
75X610	6061046	6061045	6061044	6061043	6061042	6061041
100X610	6061078	6061077	6061076	6061075	6061074	6061073



BANDAS INDUSTRIALES TELA

	40	50	60	80	100	120
150X6000	6061206	6061205	6061204	6061203	6061202	6061201
150X6200	6061222	6061221	6061220	6061219	6061218	6061217
150X6300	6061230	6061229	6061228	6061227	6061226	6061225
150X6400	6061238	6061237	6061236	6061235	6061234	6061233
150X6500	6061246	6061245	6061244	6061243	6061242	6061241
150X6600	6061254	6061253	6061252	6061251	6061250	6061249
150X7000	6061278	6061277	6061276	6061275	6061274	6061273
150X7200	6061294	6061293	6061292	6061291	6061290	6061289
120X6000	6061506	6061505	6061504	6061503	6061502	6061501
120X6200	6061512	6061511	6061510	6061509	6061508	6061507
120X6300	6061518	6061517	6061516	6061515	6061514	6061513
120X6500	6061524	6061523	6061522	6061521	6061520	6061519
120X6600	6061530	6061529	6061528	6061527	6061526	6061525
120X7200	6061536	6061535	6061534	6061533	6061532	6061531

BANDAS INDUSTRIALES PAPEL

	40	50	60	80	100	120
150X6000	6061406	6061405	6061404	6061403	6061402	6061401
150X6200	6061422	6061421	6061420	6061419	6061418	6061417
150X6300	6061430	6061429	6061428	6061427	6061426	6061425
150X6400	6061438	6061437	6061436	6061435	6061434	6061433
150X6500	6061446	6061445	6061444	6061443	6061442	6061141
150X6600	6061454	6061453	6061452	6061451	6061450	6061449
150X7000	6061478	6061477	6061476	6061475	6061474	6061473
150X7200	6061494	6061493	6061492	6061491	6061490	6061489
120X6000	6061545	6061544	6061543	6061542	6061541	6061540
120X6200	6061551	6061550	6061549	6061548	6061547	6061546
120X6300	6061557	6061556	6061555	6061554	6061553	6061552
120X6500	6061563	6061562	6061561	6061560	6061559	6061558
120X6600	6061569	6061568	6061567	6061566	6061565	6061564
120X7200	6061575	6061574	6061573	6061572	6061571	6061570

FIELTRO PARA FRATACHO LIJADORA

Codigo	Ancho	Largo
606421	150	2000

DISCOS DE FIBRA

	36	40	50	60	80	100	120
115 MM	6060466	6060465	6060464	6060463	6060662	6060461	6060460
178 MM	6060476	6060475	6060474	6060473	6060472	6060471	6060470



DISCOS CENTRO DEPRIMIDO

Código	Descripción	X Caja	U.M.
OXIDO DE ALUMINIO (PARA METAL)			
6080101	101X3.2	60	C/U
6080102	101X4.8	60	C/U
6080103	101X6.4	48	C/U
6080110	115X3.2	60	C/U
6080111	115X4.8	48	C/U
6080112	115X6.4	50	C/U
6080116	180X3.2	35	C/U
6080117	180X4.8	25	C/U
6080118	180X6.4	25	C/U
6080119	230X3.2	50	C/U
6080120	230X6.4	25	C/U
CARBURO DE SILICIO (PARA CERÁMICA)			
6080150	101X3.2	30	C/U
6080151	101X6.4	18	C/U
6080152	115X3.2	30	C/U
6080153	115X6.4	18	C/U
6080154	180X3.2	24	C/U
6080155	180X6.4	25	C/U
6080156	230X3.2	24	C/U
6080157	230X6.4	25	C/U



DISCOS DE CORTE PLANO

Código	Descripción	X Caja	U.M.
OXIDO DE ALUMINIO			
6080104	115X1	60	C/U
6080105	115X1.6	60	C/U
6080113	180X1.6	45	C/U



DISCOS DE CORTE PLANO

Código	Descripción	X Caja	U.M.
PARA MAQUINA SENSITIVA			
6080202	305X3.2X25.4	15	C/U
6080203	305X3.2X32	12	C/U
60802031	355X2.4X25.4	15	C/U
6080204	355X3.2X25.4	15	C/U
6080205	355X3.7X32	12	C/U
6080206	406X3.2X25.4	15	C/U
6080207	406X4X32	12	C/U



MECHAS DE ACERO RAPIDO

Código	Medida	U.med	Código	Medida	U.med
5218342	1.00	C/U	5218448	7.25	C/U
5218345	1.25	C/U	5218449	7.50	C/U
5218348	1.50	C/U	5218450	7.75	C/U
5218349	1.75	C/U	5218455	8.00	C/U
5218407	2.00	C/U	5218456	8.25	C/U
5218408	2.25	C/U	5218457	8.50	C/U
5218409	2.50	C/U	5218458	8.75	C/U
5218410	2.75	C/U	5218463	9.00	C/U
5218415	3.00	C/U	5218464	9.25	C/U
5218416	3.25	C/U	5218465	9.50	C/U
5218417	3.50	C/U	5218466	9.75	C/U
5218418	3.75	C/U	5218353	10.00	C/U
5218423	4.00	C/U	5218354	10.25	C/U
5218424	4.25	C/U	5218355	10.50	C/U
5218425	4.50	C/U	5218356	10.75	C/U
5218426	4.75	C/U	5218361	11.00	C/U
5218431	5.00	C/U	5218362	11.25	C/U
5218432	5.25	C/U	5218363	11.50	C/U
5218433	5.50	C/U	5218364	11.75	C/U
5218434	5.75	C/U	5218369	12.00	C/U
5218439	6.00	C/U	5218370	12.25	C/U
5218440	6.25	C/U	5218371	12.50	C/U
5218441	6.50	C/U	5218372	12.70	C/U
5218442	6.75	C/U	5218373	12.75	C/U
5218447	7.00	C/U	5218378	13.00	C/U



MECHAS DE WIDIA

Código	Medida	U.med	Código	Medida	U.med
SERIE CORTA			SERIE LARGA		
5360101	3	C/U	5360120	6 X 250	C/U
5360102	4	C/U	5360121	8 X 250	C/U
5360103	5	C/U	5360122	10 X 250	C/U
5360104	6	C/U	5360123	12 X 250	C/U
5360105	8	C/U	5360124	14 X 250	C/U
5360106	10	C/U	5360130	6 X 400	C/U
5360107	12	C/U	5360131	8 X 400	C/U
5360108	14	C/U	5360132	10 X 400	C/U
MECHA RADIAL-LAPIZ DE WIDIA			5360133	12 X 400	C/U
5360150	RADIAL	C/U	5360134	14 X 400	C/U
5360151	LAPIZ	C/U			



MECHAS PARA MADERA CON TOPE Y CENTRADORES

Código	Medida	U.med
4990501	6	C/U
4990502	8	C/U
4990505	10	C/U

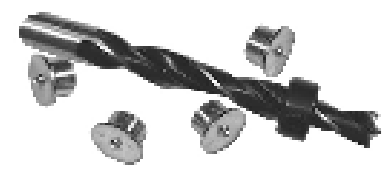

OBS: El set incluye 4 conos centradores

MECHAS PARA BARRENO

Derecha	Izquierda	Medida		Derecha	Izquierda	Medida
5070101	5070201	5		5070117	5070217	21
5070102	5070202	6		5070118	5070218	22
5070103	5070203	7		5070119	5070219	23
5070104	5070204	8		5070120	5070220	24
5070105	5070205	9		5070121	5070221	25
5070106	5070206	10		5070122	5070222	26
5070107	5070207	11		5070123	5070223	27
5070108	5070208	12		5070124	5070224	28
5070109	5070209	13		5070125	5070225	29
5070110	5070210	14		5070126	5070226	30
5070111	5070211	15		5070127	5070227	31
5070112	5070212	16		5070128	5070228	32
5070113	5070213	17		5070129	5070229	33
5070114	5070214	18		5070130	5070230	34
5070115	5070215	19		5070131	5070231	35
5070116	5070216	20		5070132	5070232	36

FRESAS PARA BISAGRAS

Código	Medida	U.med	
5300101	26 MM	C/U	
5300102	35 MM	C/U	

METROS DE MADERA

Código	Descrip.	Xcaja	U.med	
5030101	SIMPLE	12	C/U	
5030102	DOBLE	12	C/U	

LAPIZ CARPINTERO

Código	Medida	Xcaja	U.med	
5400163	Descrip.	144	C/U	

SIERRA CINTA PARA MADERA

Código	Medida	U.med		Código	Medida	U.med
5330101	15X0.6	MT		5330145	40X0.7	MT
5330105	15X0.7	MT		5330150	40X0.8	MT
5330110	20X0.6	MT		5330155	45X0.8	MT
5330115	25X0.6	MT		5330160	45X0.9	MT
5330120	25X0.7	MT		5330165	50X0.8	MT
5330125	30X0.6	MT		5330170	50X0.9	MT
5330130	35X0.6	MT				
5330135	35X0.7	MT				

OBS: Indicar medida entre dientes.

FRESAS PARA TUPI

Código	Medida	U.med
--------	--------	-------

FRESAS RECTAS DIAM 125-4Z

5310501	3	C/U
5310502	4	C/U
5310503	5	C/U
5310504	6	C/U
5310505	7	C/U
5310506	8	C/U
5310507	9	C/U
5310508	10	C/U
5310509	11	C/U
5310510	12	C/U
5310511	13	C/U
5310512	14	C/U
5310513	15	C/U
5310514	16	C/U
5310515	17	C/U
5310516	18	C/U
5310517	19	C/U
5310518	20	C/U



Código	Medida	U.med
--------	--------	-------

FRESAS RECTAS DIAM 150-6Z

5310631	3	C/U
5310632	4	C/U
5310633	5	C/U
5310634	6	C/U
5310635	7	C/U
5310636	8	C/U
5310637	9	C/U
5310638	10	C/U
5310639	11	C/U
5310640	12	C/U
5310641	13	C/U
5310642	14	C/U
5310643	15	C/U
5310644	16	C/U
5310645	17	C/U
5310646	18	C/U
5310647	19	C/U
5310648	20	C/U

OBS: Consultar por fresas para molduras

FORMONES MANGO PLASTICO

Código	Medida	xcaja
--------	--------	-------

9045029	4	6
9045030	6	6
9045031	8	6
9045032	10	6
9045033	12	6
9045034	14	6
9045035	16	6
9045036	18	6



Código	Medida	xcaja
--------	--------	-------

9045037	20	6
9045038	22	6
9045039	24	6
9045040	26	6
9045041	28	6
9045042	30	6
9045043	32	6
9045045	38	6

PRENSAS PARA CARPINTERIA

Código	Medida	U.med
--------	--------	-------

PRENSAS P-104

9047001	40	C/U
9047002	50	C/U
9047003	60	C/U
9047004	70	C/U
9047005	80	C/U
9047006	100	C/U
9047007	120	C/U



Código	Medida	U.med
--------	--------	-------

PRENSA MINI

9046015	20	C/U
9046016	30	C/U

SARGENTOS HANDYCLAMP

9045120	100	C/U
9045122	120	C/U
9045124	150	C/U
9045128	200	C/U
9045130	250	C/U

PRENSAS FLEJE

5050401	3 MTS
5050402	6 MTS
5050403	9 MTS



DESTORNILLADORES Y PUNTAS 1/4"

Código	Medida	U.med
--------	--------	-------

PLANOS

9047901	5.5X125	C/U
9047902	6.5X150	C/U

PHILLIPS

9047910	1X75	C/U
9047911	2X100	C/U
9047912	2X150	C/U

POZIDRIVE

9047915	1X75	C/U
9047916	2X100	C/U
9047917	2X150	C/U

PUNTAS CORTAS

9047801	PZ 1X25	C/U
9047802	PZ 2X25	C/U
9047803	PZ 3X25	C/U
9047804	PH 1X25	C/U
9047805	PH 2X25	C/U
9047806	PH 3X25	C/U

Código	Medida	U.med
--------	--------	-------

PORTAPUNTAS

9047940	ADAPTADOR 1/4"	
9047960	ANGULAR	

DESTORNILLADOR PORTAPUNTAS

9047941	MANUAL	
9047942	SEMIAUTOMATICO	



PUNTAS LARGAS

9047809	PZ 1X50	C/U
9047810	PZ 2X50	C/U
9047811	PZ 3X50	C/U
9047812	PH 1X50	C/U
9047813	PH 2X50	C/U
9047814	PH 3X50	C/U

CINTA DE ENMASCARAR

Código	Medida	xcaja	U.med
--------	--------	-------	-------

6064020	12	72	C/U
6064021	18	48	C/U
6064022	24	36	C/U
6064023	36	24	C/U
6064024	48	20	C/U



OBS: En rollos de 40 mts.

PLANTILLA DE INSTALACION BIS.ITALIANA

Código	Medida	xcaja	Código	Medida	xcaja
--------	--------	-------	--------	--------	-------

2110601	N'7	1	2110604	N'16	1
2110602	N'9-11	1	2110605	9-11 D/C	1
2110603	N13-14	1	2110606	13-14 D/C	1

